

RADIO CRAFT

ATOMIC
PIONEER
SEE PAGE 22



In this issue—

Color Television Systems
"Alarm" for Intermittents
Smallest Radio Equipment

JUN

1947

25¢

CANADA 30¢

RADIO-ELECTRONICS IN ALL ITS PHASES

SYLVANIA NEWS

RADIO SERVICE EDITION

JUNE

Prepared by SYLVANIA ELECTRIC PRODUCTS INC., Emporium, Pa.

1947

RADIO SERVICEMEN! SYLVANIA'S COLORFUL NEW CLOCK BIG AID IN SERVICE SALES

**Specially Designed Famous-Make Clock Identifies
Quality Stores Stocking Sylvania Tubes**



- Bright white face... black numerals!
- Minute and hour hands in black... unique second hand in attractive red!
- The words "RADIO SERVICE" in green and black. The word "SYLVANIA" in identifying green!

Fifteen-inch diameter!

Radio tube in silver and black... design of carton in familiar green and black!

Telechron movement sealed in oil; case in brown crinkle finish with silver-colored rim around face! Nominally priced at only \$7.50!

Once you place this big, colorful Telechron electric clock—with its "Radio Service" face—in *your* window, you'll have an attractive sales aid that identifies your business... every second of the day... as carrying the finest line of tubes made. Through far-reaching advertising campaigns,

your customers are being advised of the advantages of placing Sylvania "quality-controlled" radio tubes in their equipment. By displaying this on-the-spot sales help you're telling them you sell these highest quality tubes. Get this wonderful sales aid now!

ORDER FROM YOUR SYLVANIA DISTRIBUTOR or write SYLVANIA ELECTRIC PRODUCTS INC., Emporium, Pa.

SYLVANIA ELECTRIC

MAKERS OF RADIO TUBES; CATHODE RAY TUBES; ELECTRONIC DEVICES; FLUORESCENT LAMPS, FIXTURES, WIRING DEVICES; ELECTRIC LIGHT BULBS

A FREE LESSON SHOWED BILL HOW HE COULD MAKE GOOD PAY IN RADIO!

BILL, YOU'RE ALWAYS FOOLING WITH RADIO--OUR SET WON'T WORK--WILL YOU FIX IT?

I'LL TRY, MARY. I'LL SEE WHAT I CAN DO WITH IT TONIGHT



I CAN'T FIND OUT WHAT'S WRONG -- GUESS I'LL MAKE A FOOL OF MYSELF WITH MARY



HELLO, BILL--GOT A TOUGH ONE TO FIX? LET ME HELP YOU



YES, JOE -- I'M STUMPED-- BUT SINCE WHEN ARE YOU A RADIO EXPERT?

I'VE BEEN STUDYING AT HOME WITH THE NATIONAL RADIO INSTITUTE. I JUST LANDED A SWELL RADIO JOB, TOO LISTEN FOR THE CLICKS AS I SHORT THE GRID CONNECTIONS... HERE'S YOUR TROUBLE IN THE FIRST I.F. STAGE-- I LEARNED THIS TEST BEFORE I EVEN STARTED THE COURSE, FROM A FREE LESSON THE N.R.I. SENT ME



SAY, I'VE SEEN THEIR ADS BUT I NEVER THOUGHT I COULD LEARN RADIO AT HOME I'LL MAIL A COUPON FOR A FREE LESSON RIGHT AWAY



I'M CONVINCED NOW THAT THE N.R.I. COURSE IS PRACTICAL AND THOROUGH. I'LL ENROLL NOW. THEN I CAN MAKE EXTRA MONEY FIXING RADIOS IN SPARE TIME WHILE LEARNING--



SOON I CAN HAVE MY OWN FULL-TIME RADIO REPAIR BUSINESS, OR BE READY FOR A GOOD JOB IN A BROADCASTING STATION, AVIATION RADIO, POLICE RADIO OR SOME OTHER BUSY RADIO FIELD



YOU CERTAINLY KNOW RADIO. SOUNDS AS GOOD AS THE DAY I BOUGHT IT!

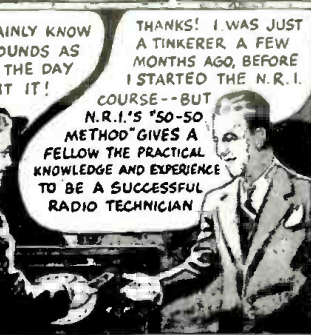

THANKS! I WAS JUST A TINKERER A FEW MONTHS AGO, BEFORE I STARTED THE N.R.I. COURSE-- BUT N.R.I.'S "50-50 METHOD" GIVES A FELLOW THE PRACTICAL KNOWLEDGE AND EXPERIENCE TO BE A SUCCESSFUL RADIO TECHNICIAN

OH, BILL-- I'M SO GLAD I ASKED YOU TO FIX OUR RADIO! IT GOT YOU STARTED THINKING ABOUT RADIO AS A CAREER, AND NOW YOU'RE GOING AHEAD SO FAST!

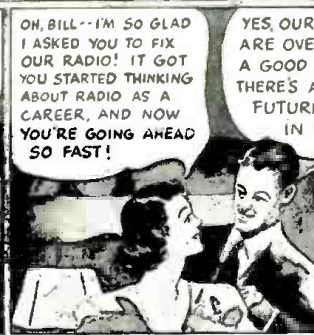

YES, OUR WORRIES ARE OVER I HAVE A GOOD JOB AND THERE'S A BRIGHT FUTURE FOR US IN RADIO

LATER

I will send you a Lesson on Radio Servicing Tips **FREE** TO SHOW HOW PRACTICAL IT IS TO TRAIN AT HOME FOR **GOOD JOBS IN RADIO**

I want to give you a copy of my Lesson, "Getting Acquainted with Receiver Servicing"—absolutely FREE! And with it, I'll send my 64-page illustrated book, "How to be a Success in Radio," also FREE. It describes many fascinating Radio jobs, tells how N.R.I. trains you at home in spare time, how you get practical experience with **BIG KITS OF RADIO PARTS** I send. MAIL THE COUPON!

Future for Trained Men Is Bright In Radio, Television, Electronics

It's probably easier to get started in Radio now than ever before, because the Radio Repair Business is booming. Trained Radio Technicians also find profitable opportunities in Broadcasting, Radio Manufacturing, Public Address work. Think of even greater opportunities as Television, FM, and many new, war-developed Electronic devices become available. Get the facts on all these opportunities. Send for FREE books now!

Many Beginners Soon Make Extra Money in Spare Time While Learning

The day you enroll I start sending EXTRA MONEY JOB SHEETS. You LEARN Radio Principles from my easy-to-understand, illustrated lessons—PRACTICE what you learn by building, testing and experimenting with parts I send—USE your knowledge to make EXTRA money fixing

OUR 33RD YEAR OF TRAINING MEN FOR SUCCESS IN RADIO

VETERANS

You can get this training in your own home under G. I. Bill. Mail coupon for full details.



neighbors' Radios in spare time while still learning! From here it's a short step to your own full-time Radio Shop or a good Radio job!

Find Out What NRI Can Do For You

Mail Coupon for Sample Lesson and my FREE 64-page book. It's packed with facts about Radio's opportunities for you. Read the details about my Course. Read letters from men I trained, telling what they are doing, earning. See how quickly, easily you can get started. No obligation! Just MAIL COUPON NOW in an envelope or paste it on a penny postal. J. E. SMITH, President, Dept. 7FX, National Radio Institute, Pioneer Home Study Radio School, Washington 9, D. C.

You Build These and Other Radio Circuits with **BIG KITS OF PARTS** I SEND YOU!

By the time you've conducted 60 sets of Experiments with Radio Parts I supply, made hundreds of measurements and adjustments, you'll have valuable PRACTICAL Radio experience for a good full or part-time Radio job!



SUPERHETERODYNE CIRCUIT (right) Preselector, oscillator-mixer-first detector, i.f. stage, diode detector—a.v.c. stage, audio stage. Bring in local and distant stations on this circuit you build yourself!

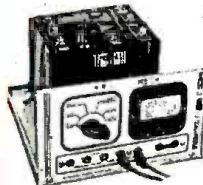

MEASURING INSTRUMENT (above) you build early in Course. Use it in practical Radio work to make EXTRA money. Vacuum tube multimeter, measures A.C., D.C., and R.F. volts, D.C. currents, resistance, receiver output.

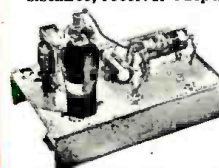

A. M. SIGNAL-GENERATOR (left) build it yourself! Provides amplitude - modulated signals for test and experimental purposes. Gives valuable practical

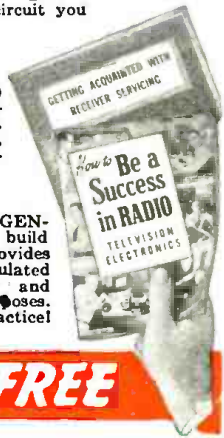

GET BOTH 64 PAGE BOOK **FREE** SAMPLE LESSON

Mr. J. E. Smith, President, Dept. 7FX, NATIONAL RADIO INSTITUTE, Washington 9, D. C. Mail me FREE, without obligation, Sample Lesson and 64-page book about how to win success in Radio and Television—Electronics. (No salesman will call. Please write plainly.)

Name
Address
City Zone State

APPROVED FOR TRAINING UNDER G.I. BILL

My Radio Course Includes Training in
TELEVISION • ELECTRONICS • FREQUENCY MODULATION

11

SHORT CUTS TO SERVICING

"Quick, easy and efficient" . . . that's how servicemen describe IRC's 11 Tap-In Shafts. No fiddling or fussing with shaft inserts or "build-ups" . . . no money tied up in stocks of exact replacements. A smart tap of the hammer and the tapered surfaces of control and shaft lock together, forming a permanently tight attachment.

In combination with the IRC Century Line of Volume Controls, these 11 Tap-In Shafts are the logical answer for over 90% of your replacement problems. Save you time and money. Time saved means extra time for other money-making jobs . . . money saved means greater profits. The latest edition of the popular IRC Volume Control Replacement Manual is now available. Contains information on nearly all models up to 1946, complete listings for the 1941-42 sets coming in now for repair. 156 pages. 25c at your IRC Distributor. International Resistance Company, 401 N. Broad St., Philadelphia 8, Pa. *In Canada:* International Resistance Co., Ltd., Toronto, Licensee.



YOU'RE ON THE AIR! A sensational new one minute spot announcement to boost service business has just been released by IRC through IRC Distributors. Listen in and cash in on this promotion!

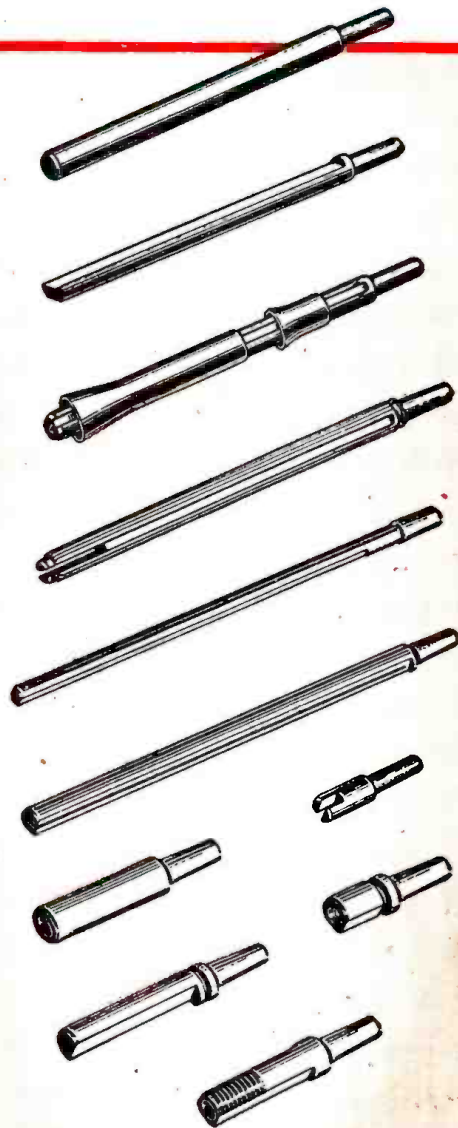

INTERNATIONAL RESISTANCE COMPANY



Wherever the Circuit says Ω

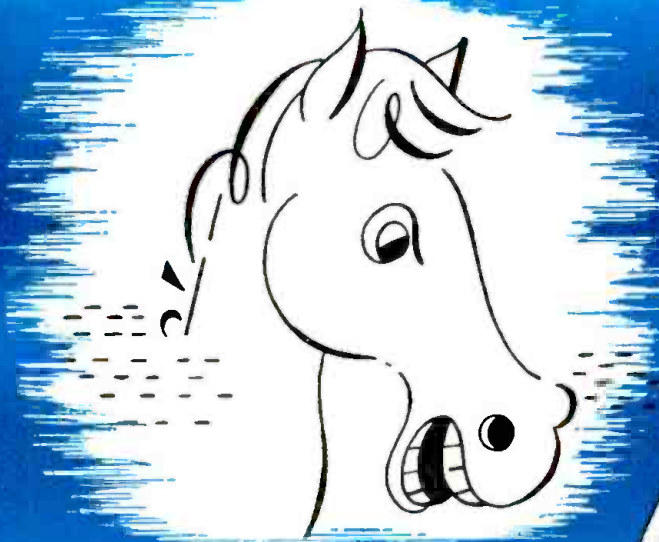

FREE



tips right out of the horse's mouth

The editor of "The Capacitor" probably won't like being referred to as a "horse's mouth." However, that's only our way of "plugging" the scores of hot ideas for servicemen that he includes in every issue of "The Capacitor."

mail coupon below
for your free
subscription to the
C-D capacitor

Here's a magazine that's published for servicemen only. Every month it is loaded with ideas for speeding up service procedures—for increasing store traffic—for adding new dollars to your income. Its convenient, pocket-size pages contain valuable technical data—information on the new type tubes—notes on trouble shooting. Yes, and also dozens of helpful hints that will help you to repair any radio ever made, easier, better and twice as fast.

Accept "The Capacitor" with C-D's compliments. Put it to work in your shop speeding up repair jobs—building bigger profits. *Don't wait! Mail coupon below NOW, so your FREE subscription will start at once! Cornell-Dubilier Electric Corp., Dept. RC-6, South Plainfield, New Jersey.*

TITLES OF ARTICLES IN RECENT ISSUES—These articles are typical of the ones you'll find in "The Capacitor" every month: *How to Use Audio Oscillator and Signal Generator to Simplify Tests*—*New Requirements of FM and Television Servicing*—*Hum Elimination*—*Aligning Superhets*. Think how such articles will help you—mail coupon NOW.

FINDS "THE CAPACITOR" OF GREAT INTEREST—Washington, D. C. service shop owner writes, "I wish to thank you for mailing me 'The Capacitor.' The special items are of particular interest because of their easy reading and their simplification of complex circuits."

FREE ADS FOR SERVICEMEN—Yes, that's right—your ad will be run absolutely free in The Trading Post which appears in all issues of "The Capacitor." Use this service to buy that new tester you've been wanting—to sell that spare 'scope—or to work out a swap with other servicemen.

MICA

DYKANOX

PAPER

ELECTROLYTIC

1910 1947



CORNELL-DUBILIER
WORLD'S LARGEST MANUFACTURER OF
CAPACITORS

CLIP THIS COUPON—MAIL AT ONCE

Cornell-Dubilier Electric Corporation Dept. RC-6
South Plainfield, New Jersey

Please start my FREE subscription to "The Capacitor"
at Once.

Name.....

Address.....

City..... Zone..... State.....

Announcing
**THE NEW ADDITION TO OUR
 RADIO SCHOOL**

**OWN YOUR OWN
 RADIO SHOP
 BE YOUR OWN BOSS**

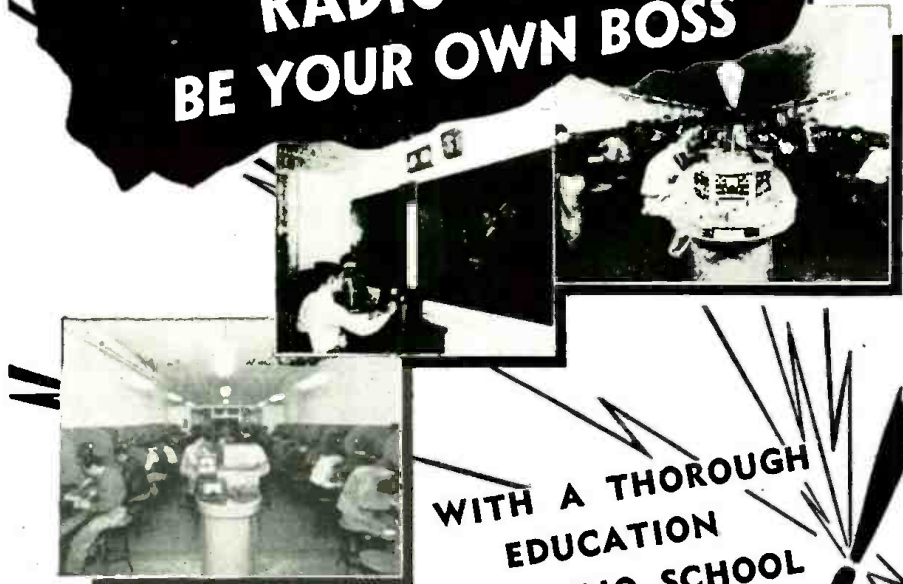

**WITH A THOROUGH
 EDUCATION**

FROM OUR COMPLETE RADIO SCHOOL

Radio (and its allied fields—electronics, television, radar) now looms as a major industry in the United States offering a constant and ever-expanding field of wealth and opportunities. Each new development points the way toward further improvements and an increasing demand for men and women, specialized in this field.

The Radio courses offered by the Tyler Commercial College are highly specialized to enable you to enter many branches of radio, both as your vocation or your profession. The present courses listed represent a partial list of the extensive and complete training offered by the Tyler Commercial College who have had over 30 years experience in the Radio Training Field.

They invite you to examine the content of their catalogue and determine for yourself how radio training at Tyler Commercial College will enable you to find your own place in one of the many interesting and profitable jobs in the vast radio industry.

TYLER COMMERCIAL COLLEGE
115 South College Tyler, Texas

APPROVED BY
 VETERANS ADMINISTRATION

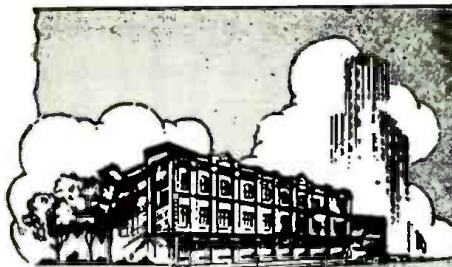

GENERAL RADIO COURSE

The course in General Radio is designed to provide a broad foundation for careers in the technical radio field. Among the various job objectives are Radiotelephone Operator (broadcast, police, or airline), Radiotelegraph Operator (marine, zone police, or airline), and Radio-Electronics Technician (industry). Success in qualifying for F.C.C. Radiotelephone or Radiotelegraph License is a requirement for graduation; therefore, an extensive study of radio theory, essential radio mathematics, and laws and regulations governing radio communications is included in preparation for operator license examinations.

Average Time to Complete Course . . .
 12 Months

**RADIO MAINTENANCE
 AND REPAIR COURSE**

The Radio Maintenance and Repair Course offers preparation for a career as radio receiver repairman, sound-system technician, and radio service shop operator. Accurate, up-to-the-minute knowledge of radio principles and practice is essential for future success in this important field of radio. After a thorough introduction to radio and electrical principles, emphasis is directed to modern trouble-shooting methods, notable "signal-tracing." A section on facsimile receivers, frequency-modulation (FM) receivers and television sets is provided to bring the repairman up-to-date on recent developments. A wide range of topics is covered in this course, all of which are important to the modern repairman.

Average Time to Complete Course . . .
 10 Months

Send for Free Catalogue

For full details and catalogue regarding this unique school, write to The Tyler Commercial College, Radio Department, RC, 115 South College, Tyler, Texas.

Attach this to your letter head or card.

MAIL TODAY

A STATE APPROVED
 INSTITUTION

Like having an EXTRA MAN in your shop

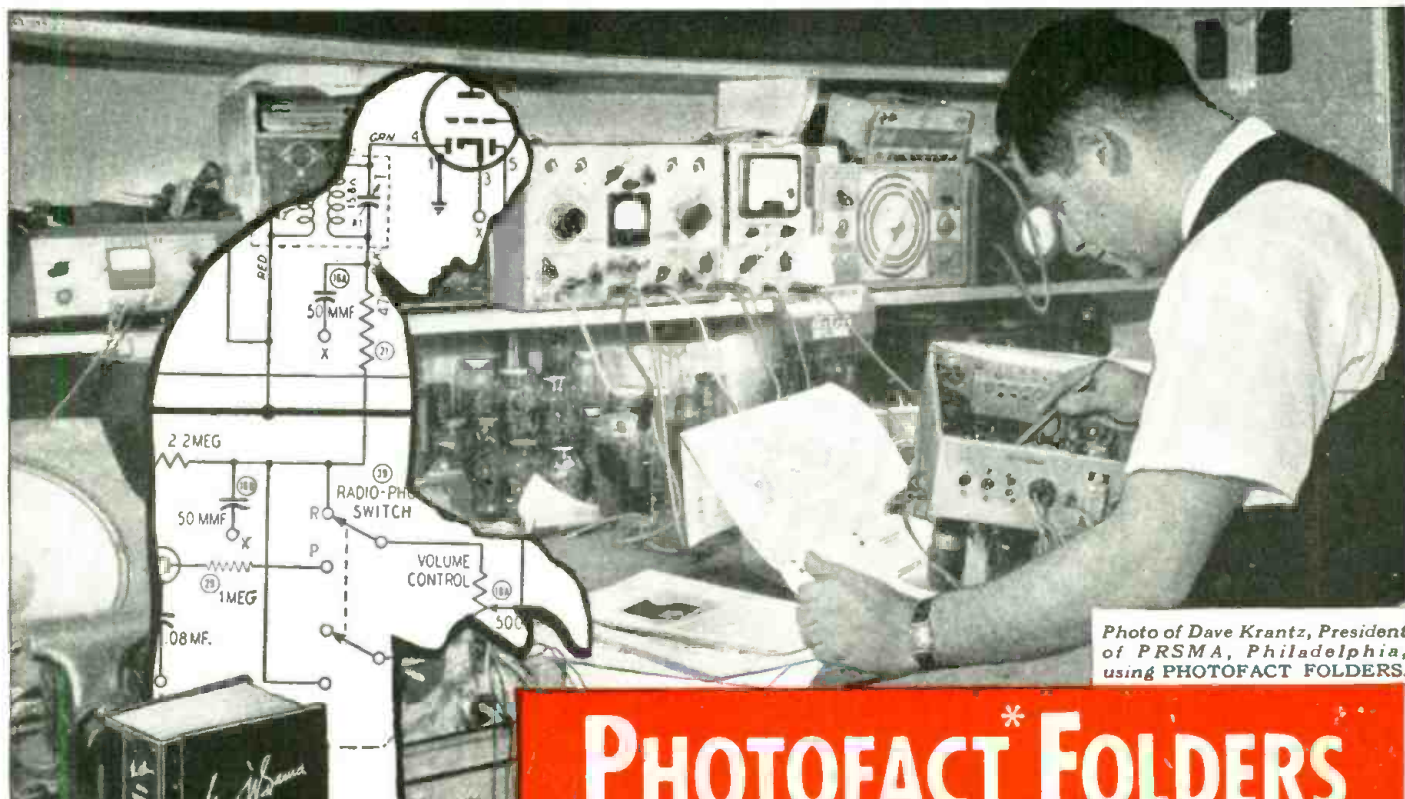

Photo of Dave Krantz, President of PRSMA, Philadelphia, using PHOTOFACT FOLDERS.



VOLUME 1, containing first ten sets of PHOTOFACT FOLDERS in de luxe binder, \$18.39. Individual sets Nos. 1 to 10, \$1.50 each. De Luxe Binder alone, \$3.39.

*PHOTOFACT FOLDERS

HELP YOU EARN MORE MONEY...

Cost less than 9¢ a day

COMPLETE ✓

Everything you need in one handy, unified form—large schematics, pictorials keyed to parts lists and alignment data, complete listings of parts values and replacements, alignment, stage gain, circuit voltage and resistance analysis, *coil resistances*, dial cord stringing, disassembly instructions, record changer analysis and repair.

ACCURATE ✓

All sets are actually taken apart and analyzed by experts in the Sams laboratories. Every part is measured, tested and triple-checked for accuracy. All data is original. This means the data you get is *right*.

CORRECT ✓

PHOTOFACT FOLDERS are issued twice monthly, as the new receivers come off production lines. You don't have to wait for information. As receiver changes are made, you get correction and addition sheets for your files. Your data is always up to the minute.

READY TO USE ✓

All diagrams and pictures are coded to numbered parts lists. Everything is positively identified for fast work. All folders are set up in uniform, easy-to-follow style: big type, big illustrations—no hunting, guessing or eye strain—no more loss of time and temper.

"Like having an extra man in my shop" . . . "The kind of 'specialist' I need" . . . that's what hundreds of radio servicemen say about PHOTOFACT FOLDERS. Yet this indispensable "hired help" actually costs less than 9 cents a day!

Here are the straight facts: PHOTOFACT FOLDERS offer the *best information ever prepared for radio servicemen*—complete, accurate, up-to-the-minute, easy to use. They save you hours of time and effort because they place at your fingertips ALL the information you need to do a better job. And that means you can earn MORE MONEY.

The information in PHOTOFACT FOLDERS is *right* because it is based on *actual analysis of sample sets* right in our own laboratories. It is *complete and current*, too, because it covers *all* radios, phonographs, record changers, recorders, communications systems and power amplifiers as they reach the market.

PHOTOFACT FOLDERS come to you in sets of 30 to 50 at only \$1.50 per set. Low as this price is, it also includes membership in the Howard W. Sams Institute.

Set No. 19 will be ready for mailing May 10th. Set No. 20 on May 25th. Sets Nos. 11 to 18 inclusive, also priced at \$1.50 each, are available for immediate order.

Actually, PHOTOFACT FOLDERS cost you nothing since they pay for themselves again and again. They're ready to help you *now*—at the most difficult time in servicing history. See your distributor or write us today. In Canada, address A. C. Simmonds & Sons, 301 King Street East, Toronto, Ontario.

PHOTOFACT FOLDERS cost you nothing since they pay for themselves again and again. They're ready to help you *now*—at the most difficult time in servicing history. See your distributor or write us today. In Canada, address A. C. Simmonds & Sons, 301 King Street East, Toronto, Ontario.

HOWARD W. **SAMS** & CO., INC.

2924 EAST WASHINGTON STREET, INDIANAPOLIS 6, INDIANA

PHOTOFACT SERVICE

"The service that pays for itself over and over again"



Frequency-Modulation radio reception is virtually free from natural static—even thunderstorms do not interrupt.

FM Radio—another world in listening pleasure!

It's as though the orchestra were right in the room with you—and the room suspended in the silence of space. When you listen to music over RCA Victor FM, you hear FM at its finest.

Natural static interference ordinarily caused by thunderstorms does not mar FM radio reception. You are in a different, new world of utter quiet where you hear only the lifelike music. Moreover, you enjoy the same perfect reception day or night.

The vast experience, research and skills at RCA Laboratories, such as aided in the development of RCA Victor

FM, are constantly applied to all RCA products, so that each one is always at the top of its field.

And when you buy anything bearing the RCA or RCA Victor name—whether it's a radio (standard, or FM, or both), a television receiver, Victrola radio-phonograph, a phonograph record or a radio tube, you know you are getting one of the finest of its kind that science has yet achieved.

Radio Corporation of America, RCA Building, Radio City, New York 20 . . . Listen to The RCA Victor Show, Sundays, 2:00 P.M., Eastern Time, over NBC. "Victrola" T.M. Reg. U. S. Pat. Off.



With the new RCA Victor AM-FM sets you'll hear FM radio—and standard AM radio too, at their finest. Ask your RCA Victor dealer for a demonstration of the fine new Crestwood series of Victrola AM-FM radio-phonographs.



RADIO CORPORATION of AMERICA



NOW! An Amazing Opportunity to LEARN RADIO AT HOME

I SEND YOU 8 BIG KITS OF RADIO PARTS

Including a **COMPLETE 6 TUBE SUPER-METERODYNE RECEIVER**

I TRAIN YOU RIGHT by PUTTING YOU TO WORK with REAL PROFESSIONAL EQUIPMENT!

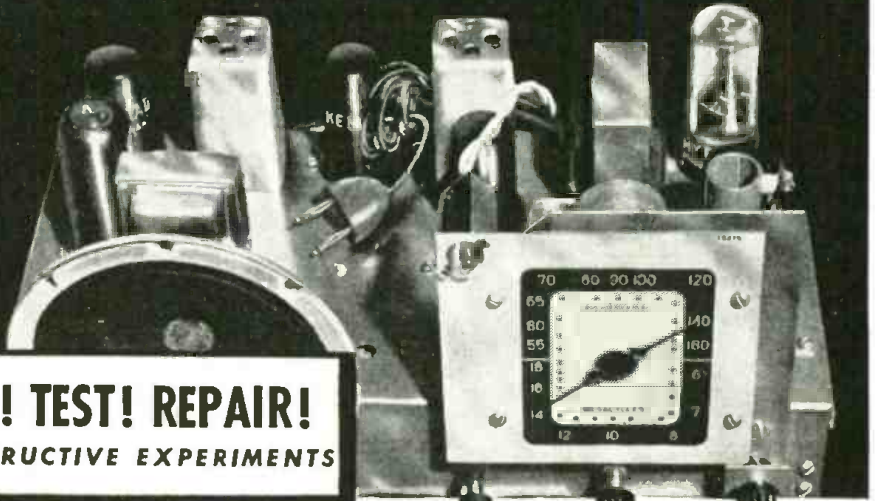

LEARN HOW TO BUILD CIRCUITS! TEST! REPAIR!
YOU DO OVER 175 INSTRUCTIVE EXPERIMENTS

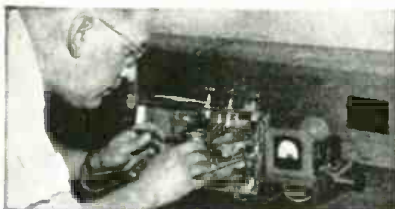

YOU BUILD THIS USEFUL TEST EQUIPMENT!

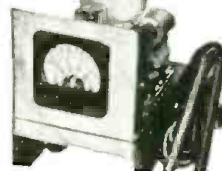

I give you a fine, moving-coil type Meter Instrument on Jewel Bearings — with parts for a complete Analyzer Circuit Continuity Tester. You learn how to check and correct Receiver defects with professional accuracy and speed.

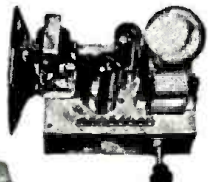

You'll get valuable experience and practice building this Signal Generator and multi-purpose Tester. Makes a breeze out of fixing Radios and you don't have to spend money on outside, ready-made equipment.

HERE'S THE EASIEST, MOST PRACTICAL WAY OF ALL TO PREPARE FOR GOOD PAY in RADIO ELECTRONICS and TELEVISION!

I train your mind by putting you to work with your hands on a big 6-Tube Superheterodyne Receiver. And, believe me, when you get busy with real Radio Parts — 8 big Kits of them — you really LEARN Radio and learn it RIGHT! You get the practical stuff you need to be useful in Radio, and that's what it takes to make money. You don't have to worry about what to do with these 8 Kits of Parts. Step by step, I show you how to build circuits, test, experiment, trouble-shoot. And you don't need any previous experience. The Sprayberry Course starts right at the beginning of Radio! You can't get lost! Simplified lessons, coupled with real "Shop" practice, makes every subject plain and easy to understand and remember. Soon after you begin Sprayberry Training, I'll send you my sensational BUSINESS BUILDERS.

A BUSINESS OF YOUR OWN . . . OR A GOOD RADIO JOB

You'll find out how to get and do neighborhood Radio repair jobs for nice profits and rich experience while learning. This sort of work can easily pave the way for a Radio Service business of your own. But with Sprayberry Training, you're not limited. You can swing into any one of the swiftly expanding branches of Radio-Electronics INCLUDING Radio, Television, FM, Radar, Industrial Electronics. Be wise! Decide now to become a fully qualified RADIO - ELECTRONICIAN. Get full details about my Training at once! Mail coupon below for my 2 big FREE Books.



RUSH COUPON!

SPRAYBERRY ACADEMY OF RADIO

F. L. Sprayberry, President, Room 2067, Pueblo, Colorado

Please rush my FREE copies of "How to MAKE MONEY in RADIO, ELECTRONICS and TELEVISION," and "HOW TO READ RADIO DIAGRAMS and SYMBOLS."

Name Age

Address

City State

(Mail in envelope or paste on penny postcard)

GET THESE VALUABLE FREE BOOKS

"How to Read Radio Diagrams and Symbols"

Here's a valuable and wonderfully complete new book which explains in simple English how to read and understand any Radio Set Diagram. Includes translation of all Radio symbols. Send for this volume at once. It's free! Along with it, I will send you another Big Free book describing in detail my Radio-Electronic Training.

B-19 Radio Receiving and Transmitting equipment. Has 3 different sets—made for U. S. tanks
 #1. Transmitter and Receiver 2 to 8 Mc.
 #2. 235 Mc. Transceiver.
 #3. Intercommunication system—our price for the B-19 Complete... \$78.50
 Power Output CW 35 Watts
 Phone 25 Watts

RM-29B Remote Control Units to control transmitters. Can be used for telephone intercom work. Has bell ringer. Two 1134-29 or similar RM's in combination with two handsets like regular telephone.
 Total\$21.00

SCR 610 FM Transmitter-Receiver. Frequency range 27 to 33 Mc. Crystal Controlled. Operates on 6 or 12 V DC or Battery Input. Complete to last detail. Used condition\$69.50

Condensers
Pyranols Dykanols — Etc.

1 mf 300 vdc	20
2 mf 300 vdc	25
4 mf 300 vdc	30
4 mf 400 vdc	50
5-5 mf 400 vdc	1.05
2 mf 550 vdc	25
.25 mf 600 vdc	20
.15 mf 600 vdc	25
1 mf 600 vdc	30
1-1 mf 7000 vdc G.E. Pyr.	2.00
2 mf 600 vdc	35
10 mfd 600 V.	50
1 mf 1000 vdc	75
1 mf 1000 V.	25
1 mf 1500 vdc	95
4 mf 1500 vdc	15
2 mf 600 ac/1000	1.20
1 mf 1500 vdc	1.50
1 mf 2000 vdc	1.60

Tube Special

Tube Type	Your Price	Tube Type	Your Price
2AP1	\$3.75	837	\$1.35
3BP1	3.95	872A	2.45
3FP7	3.50	3B2	3.95
5BP1	4.95	705A	6.75
5BP4	7.95	241-B-WE	30.00
5CP1	4.95	861	39.00
5FP7	4.25	304 TL	8.00

Sockets for 5CP1, 5BP1, 3BP1, 705A, 82995 ea.

TRANSFORMERS

**Pulse
 High Voltage
 Power Supply
 Audio**



Raytheon Pulse Transformer UX 4298 E. Pri: 4 KV. @ 1 microsecond; secondary: 16 KV @ 16 amps. Filament pri: 115 V/400 cycles\$15
W.E. Hi Volt Input pulse transformer #D169211.\$9.95
G.E. Radar pulse transformer K2731. Diameter app. 11". Vertical cooling fins \$19.50
Prim: 117 V/60 Cycle. Secondary: 500-400-0-400-500 @ 250 ma. and 6.3 V. @ 1.5 amps. Dimensions 5" x 4" x 6" app.\$6.95
Prim: 117 V/60 Cycle—3.8 amp. Secondary: 980 V. @ 450 ma. no C.T. Dimensions app. 5 1/2" x 6" x 5" \$4.95 ea.\$9.00 fr.
**Prim: 117 V/60 cycle. Sec. 6.3 V. @ 9 amps. center tapped; 6.3 V. @ 2.2 Amp; and 6.3 V. @ 2.2 amps. Three secondaries. app. 4" x 4 1/2" x 5"\$3.75
Filament Transformer Raytheon #UX6899. Primary 115 V/60 cycles. Secondary #1—5 V. @ 5.5 amps. Secondary #2—5 V. @ 5.5 amps. Tested for 29,000 Volts insulation\$12.95
2KVA Transformer and choke primary 110V/60 Cycles. Single Phase. Output 17,000 volts @ 141 ma. Choke 4,000 Hx @ 0 current. DCR 4500 ohms. Dimensions 26" x 29" x 13". Amertran\$74.50**

**Here's an unusual transformer special! AC in, DC out. A rectifier unit is incorporated inside the transformer. You will find many money-saving uses for this rectifying transformer. Made by Federal Tel. #RA 7067-1. Primary 117V/50 to 62 cycles. Secondary: 62 V DC @ 3.5 amps. Use it with a rheostat to run DC units directly from your house line. A buy at\$3.95
**115 Volt/60 cycle pri.—Secondaries: 470V. CT @ 60 ma and 6.3 V. and 5 V. \$1.50
 6 Henry choke—60 ma—to match above 65e
 Utah—small blocking oscillator type transformer—either 9218 or 9308.....ea. 75c
 A special buy for you if you can use 400 cycle transformers. We have most of our small 400 cycle transformers on sale at 50c each. Larger sizes proportionately low. Send us your approximate voltage requirements. We'll fill your order.****

Audio Transformers, modulators, etc.
**Modulation Transformer, 807 to pair of 807s.....\$1.00
 Line to Voice coil transformer. Pri: 600 ohms; sec: 6 ohms.
 Sub Sig. Type #CRP 30448\$1.00
 UTC Type #83718—Primary 600 ohms CT. Secondaries: 4,000 ohms and 150 ohms. Eachonly 50c**



**"Communications"
 MICROWAVE SPECIALS**

MICROWAVE PLUMBING

Three Centimeters

**Wavemeter (Maguire Industries #1539TFX-21GA) 3 centimeter cavity. Vernier Driven Dial\$20.00
 Wave guide 15° bend 16" long cover to cover3.00
 Wave guide 30° bend 16" long choke to cover3.00
 "T" Section5.50
 Wave guide 90° bend E Plane 18" long5.50
 Wave guide 180° bend with pressurizing nipple 12 1/2"2.50
 Wave guide "S" curve 18" long cover to choke3.50
 Wave guide "S" curve 8" long cover to choke2.50
 Wave guide 2 1/2 ft. long 180° bend choke to cover5.95
 Section Rigid coax 18" 58 ohm Z has 1/4 wave section4.00
 Pick up loop with adjustable tuning section used in duplexer... 1.50
 Brass choke Opening 1" x 1/2"60
 5 feet 3 cm wave guide per foot..... 1.95**

Ten Centimeters

**Coax rotary joint with deck mounting8.00
 Coax coupler connects 9/16" coax to 3/4" coax magnetron coupler2.50
 Standing wave detector Coax 58 ohm5.00
 Sand Load (Dummy Antenna) Wave Guide section with cooling fins. App: 23" high35.00
 Wave Guide to Rigid Coax at right angle. App: 10" high. Gold plated has mounting flange25.00
 10 cm Wave guide—16 foot lengths—per foot2.00
 Signal Generator I-138 made by Western Electric. 2700 to 3000 MC. Operates on 115 V/60 cycles. Regulated power supply and has output meter75.00**

1.25 Centimeter

**"T" Section Choke to cover4.50
 Mitred elbow—cover to cover3.50
 Flexible section 1"—choke to choke3.00**

MAGNETRONS — KLYSTRONS, ETC.

**3131 (one CM) listed at \$95.00. Our Price\$20.00
 2132 Magnetron (10 CM) 250 KW Peak Pulse Power. Technical data supplied. Brand new in original packing. Listed at \$200. Our price25.00
 720 Magnetron—260 MC.—Value \$200. Our price20.00
 2126 Magnetron (10 CM)25.00
 Magnets for the above magnetrons12.00
 2138 Magnetron (3245-3263 Mc.) Complete with magnet37.50
 Klystron—2K25/ 723 AB (3 CM) Technical data supplied. Listed at \$38..... 7.75
 Sockets for 723 AB Klystron Ea.35
 McNally—707B (10 CM) with Cavity15.00
 External Cavity for 707B3.50
 Thermistor Beads—used in microwave measurements, either D167332 or D170396 (W.E.)95
 Thermistors—Button type, either D168391 or 168391 or D168392 (W.E.)95
 Magnetron Stabilizer (3 CM) Assembly is made up of a 3 CM magnet and magnetron stabilizer cavity. Clnaudograph Type UC 21022.50**

IFF Equipment. Includes pulse Transmitter-Receiver RC 1267 and Power Supply RA 105A. Operates on 117V/60 cycles. Frequency 157 to 187 Mc. Can be used as a low power radar unit as is if coupled to a cathode ray tube. Or very easily modified for work on the 2 meter band. Has 5 stagger tuned IF stages which makes it easily adaptable for FM or Television work. The power supply furnishes all operating voltages. These two units in excellent condition fit into a metal rack which is also provided. G.C. \$2,500. Our special price RC148\$59.50

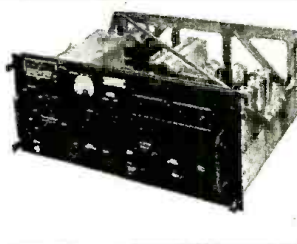

SO RADAR

10 Centimeters. Extensively used by the U. S. Navy for search and blind navigation. Plan position indicator continuously draws a map of surrounding area. Range from 4 to 80 miles. New in original crates, including all spare parts as supplied to the U. S. Navy by Raytheon Mfg. Co. for installation. Spare parts, alone in many cases provide 4 replacements for each part.

Write for our special low price

**So Radar, used. Includes Transmitter-Receiver, indicator, Motor Generator set. Echo box, section of 10 CM wave guide and BRAND NEW antenna assembly \$500
 Separate units which make up the SO Radar.
 These are used but in excellent condition.
 Motor Generator set\$85
 Transmitter-Receiver unit. Contains the magnetron, the RF assembly, and the Receiver IF strip. All tubes included\$150
 Indicator Unit—Contains the Plan Position indicator tube, video amplifier, and all video display controls\$100**

SEND FOR OUR LATEST FLYER

All merchandise guaranteed. Mail orders promptly filled. All Prices F.O.B. New York City. Send Money Order or Check. Shipping charges sent C.O.D.

**COMMUNICATIONS
 EQUIPMENT CO.**

131-C Liberty St., WH 4-7658, New York City 7, N. Y.

SPECIAL ITEMS

AN/PRS 1 Mine Detectors for detecting both metallic and non metallic materials. Indication both aural and visual, slightly used\$17.95
Tuning Unit. Ideal basis for E.C.O. rig. Has osc., final & ant. loading tanks, for TCE or GP-7 in the following frequencies A—350 to 800 KCs; B—800 to 1500 Kcs; C—1500 to 3000 KCs; D—3000 to 4625 KCs; E—4625 to 6500 KCs. Plus in units app: 1" all sides. Contains all coils, etc., for these frequencies. Order by frequency. State your 1st and 2nd choice\$2.75
Sonar Sound Detection Unit. Couple this underwater sound detector to an audio amplifier. You can hear a school of fish within a 15 mile area. The Rochelle salt crystal used in this unit is 1,000 times more sensitive than quartz. 60 feet of cable supplied. SD-1 app: 18"\$6.95
**Visors for 5 inch scopes75
 Tube shields for 2 AP198
 Silver button mica condensers. 175 and 185 mmf. ea. .05
 Lots of 1004.50
 Silver button mica condensers. 500 mmf. Each10
 Lots of 1009.50
B-29 Computer-Amplifier contains 8 6SN7s, 5 Neons, 8 relays. Completely wired, and in brand new condition9.95
Master Base—Flexible, 18" long. Extremely rugged construction. Low capacitance \$5.65
High Voltage cup shaped mountings 3" diameter fit on both sides of insulator surface\$2.65
Phasing condenser — 4 section. Western Electric D 150734 (List \$20)\$2.00
Headphones. Leather covered band—8,000 impedance with 6 ft. cord and detachable rubber cushions. Brand new\$1.95
 Used—in good condition\$1.00
Dipole Antenna (440 MC.) Made for the ARN-1 F.M. altimeter. Beautiful aircraft construction. Easily mounted and has coax connector\$2.25
War Department Technical Manual for Radio Sets SCR 508—SCR 528 and SCR 538. 239 Pages of Schematics, Maintenance, Instructions and theoryonly 50c
Selsyn Motors—operate on 115 volts 60 cycles. New\$7.75 pair
Synchro capacitor to go with Selsyns. 10-10 mfd @ 90 V. G.E. Mark 1 Mod. 2 Type 3C. Greatly improves performance of synchro system\$2.30
 Combination pair of selsyns and synchro capacitorspecial price \$9.50**

RELAYS!

Here are values you'll never beat



TIME DELAY CRAMER—clockwork relay. 115V/60 cycle. 10 amp rating\$2.95
Edison tube type, sealed thermal relay. 45 to 60 second delay. \$10 value\$2.95
Struthers Dunn 125 V. DC. 3 amp Type ADIT 8. A rugged relay mounted on bakelite base. DPST\$1.50
G.E. Time Delay Relay 115V/60 Cycle. 10 amp rating Type CR2810-1265. 1 contact SPST open; 1 contact DPDT closed \$2.10
G.E. Underload relay Type CR2810-1265. High ampereage. Sturdy construction on 1/2-inch bakelite base\$1.50
Telephone type DPST; 1 closed, 1 open. Contact rating 5 amps at 50 V. Coil rating 3.5 ma.\$1.05
**Leach DPST 115V/60 c.....\$1.39
 6 Volt AC DPDT Duncos.....\$1.50
 6 Volt AC DPST Duncos.....\$1.20**

DC Relays

**Leach, Kurman, Advance and other well-known makes
 SPST, 12 or 28 Volts, ea.....50
 DPDT, 12 or 28 Volts, ea.....60
 TPDT, 12 or 28 Volts, ea.....70
 Discounts on lots—100, 10% 1000, 15%
 5000, 20%**

**MICRO WAVE
 ANTENNAS**

**Designed for Your directional and experimental work.
 SO Antenna assembly (10 CM) complete antenna assembly including drive mechanism, RF radiating assembly, parabolic reflector, 24" diameter and radome. BRAND NEW, in original crate\$90
 Used, and in good condition\$45
TDY Antenna includes Parabola, hood, driving mechanism 30" beam! In original crates\$100
Parabolic Reflector—made of aluminum ribs. By "Budd". Used for 10 Cm. wave. Dimensions app: 4 1/2 x 3'. Has a mounting neck for insertion on piping—rotatable. Ideal for micro-wave relay work. In original crates\$100
SCR-518 Radar altimeter. Complete and new! In original crate. Contains transmitter, receiver, antennas and 3" calibrated indicator. 20,000 ft. range. Ready for complete installation\$279**

Now IN YOUR OWN HOME *Learn*

RADIO ELECTRONICS

The Practical
 "HOME-TESTED"
Modern "A-B-C" Way



YOU USE ALL OF THESE RADIO PARTS
 TO BUILD AND OPERATE
7
 DIFFERENT RADIO RECEIVING CIRCUITS

WITH THE HELP OF

A EIGHT Big Kits of Actual "Learn-by-Doing" Radio Parts and Assemblies with which you make 133 fascinating SHOP METHOD EXPERIMENTS in your own home! Imagine building 7 different Radio Receivers that operate!

B A 16 mm Home Movie Projector and Twelve Reels of "Learn-by-Seeing" Home Movie Films . . . for picture-clear, fast understanding of Radio Fundamentals!

C Modern, well-illustrated, Loose-leaf Lessons, prepared in clear, simple, understandable language . . . to guide you throughout your training!

NO PREVIOUS RADIO OR ELECTRICAL EXPERIENCE NECESSARY

DeForest's Training, Inc. provides every major home study aid to help you learn Radio-Electronics rapidly and thoroughly . . . to give you the experience and confidence needed for a responsible, Good-Pay Job, or to Start a Business of Your Own! Here is a REAL opportunity field for YOU . . . when you are a trained Radio-Electronics man! Just think of the tremendously exciting future ahead of FM Radio, Aviation and Broadcast Radio, Sound Motion Picture Equipment, Servicing and Sales of Radio Equipment, etc. Put yourself in this picture . . . See how you can benefit from a PRACTICAL training in this fascinating work! Think, too, of the coming possibilities ahead of Radar, Facsimile and Television. Send TODAY for the interesting, opportunity-revealing book, "Victory for You!" See how others probably no more talented or ambitious than you, have advanced in earning power after this training . . . how YOU can do it too! Mail the coupon NOW!

INCLUDING:

1. Simple Receiver
2. Two Tube Receiver
3. Tuned Radio-Frequency Receiver
4. Short Wave Receiver
5. Aviation Band Receiver
6. 4-Tube Superheterodyne
7. 5-Tube Superheterodyne with Magic Tuning Eye

... PLUS SCORES OF OTHER FASCINATING, INSTRUCTIVE RADIO-ELECTRONIC EXPERIMENTS

THEN GET THE HELP OF OUR EFFECTIVE EMPLOYMENT SERVICE

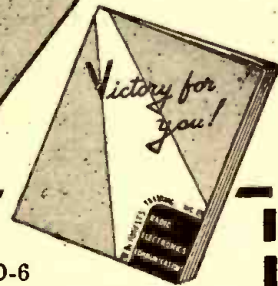

VETERANS!

Big things are happening at DeForest's Training, Inc. for veterans! See how you can prepare yourself WITHOUT COST for a GOOD JOB or a BUSINESS OF YOUR OWN in the vast Radio-Electronic opportunity field.

16 MM MOVIE PROJECTOR YOU USE "LEARN-BY-SEEING" MOVIES



DEFOREST'S TRAINING, INC. INCLUDES INSTRUCTION IN MOTION PICTURE SOUND EQUIPMENT, FM RADIO AND TELEVISION . . . RESIDENTIAL TRAINING IN OUR MODERN CHICAGO LABORATORIES ALSO AVAILABLE—ASK US FOR INFORMATION!

DeFOREST'S TRAINING, INC.
 CHICAGO 14, ILLINOIS

E. B. DEVRY, President
 DeFOREST'S TRAINING, INC.
 2535-41 North Ashland Ave., Dept. RC-D-6
 Chicago 14, Illinois, U.S.A.

Send FREE "VICTORY FOR YOU!" BOOK, showing how I may make my start in Radio Electronics.

Name _____ Age _____

Address _____ Apt. _____

City _____ Zone _____ State _____

If under 16, check here for special information. If a discharged Veteran of World War II, check here.

RADIO CRAFT

▼ AND POPULAR ELECTRONICS ▼

Incorporating
SHORT WAVE CRAFT TELEVISION NEWS
RADIO & TELEVISION

Editorial: FM and Altitude by Hugo Gernsback 17
Radio-Electronics Monthly Review 18, 19
Radio Thirty-five Years Ago 75

Electronics

Color Television, Part I by H. W. Secor 20
Pioneer Atom Splitter (Cover Feature) 22
"Shooting Stars" Tracked by Radio by S. R. Winters 26
Antenna Principles, Part VII—Parabolic Reflectors as Antennas by Jordan McQuay 27
Television for Today, Part XIII—Problems of the Cathode-Ray Tube by Milton S. Kiver 36

Amateur Radio

V.F.O. Exciter or Transmitter, Part I—Variable Frequency Oscillators by I. Queen 30

Servicing

Noise Elimination by Jack King 29
Demonstration Transmitters by Harold McDuff & George Pyle 35
Radio Data Sheet 347 (Motorola Auto Radio 1946 CR-6) 38

Sound

A Small Recording Studio, Part IV—Operating the Recording Equipment,
Speed, Needle and Record Cut Considerations by J. C. Hoadley 32

Test Instruments

Intermittent Alarm by J. Jacobson 34

Construction

New Subminiature Printed Circuits 24
Battery Superhet Uses Three Tubes by William Hedrich 31

Departments

Transatlantic News by Major Ralph W. Hallows 33
Radio-Electronic Circuits 42
Try This One! 46
Technotes 48
Question Box 50
New Radio-Electronic Devices 52
New Radio-Electronic Patents by I. Queen 54
World-Wide Station List Edited by Elmer R. Fuller 60
Communications 76
Book Reviews 80

HUGO GERNSBACK
Editor-in-Chief
FRED SHUNAMAN, *Managing Editor*
M. HARVEY GERNSBACK,
Consulting Editor
ROBERT F. SCOTT, W2PWG,
Technical Editor
I. QUEEN, W2OUX, *Editorial Associate*
ELMER FULLER, *Shortwave Editor*
ANGIE PASCALE, *Production Manager*
G. ALIQUO, *Circulation Manager*
JOHN J. LAMSON,
Advertising Director
ALFRED STERN, *Promotion Manager*

In A Future Issue:

V.F.O. EXCITER-TRANSMITTER
BUILD YOUR OWN DYNAMIC
PHONOGRAPH PICKUP
USE FOR OLD TUBE CHECKER

ON THE COVER:



Dr. Enrico Fermi, pioneer research worker in atomic fission, adjusts controls of electronic equipment in the Argonne laboratory. Chromatone by Alex Schomburg from University of Chicago Photograph.



RADCRAFT PUBLICATIONS, INC. Hugo Gernsback, President; M. Harvey Gernsback, Vice President; G. Aliquo, Secretary

Contents Copyright, 1947, by Radcraft Publications, Inc. Text and illustrations must not be reproduced without permission of Copyright owners.
RADCRAFT PUBLICATIONS, INC. • PUBLICATION OFFICE 29 Worthington Street, Springfield 3, Mass. • EDITORIAL AND ADVERTISING OFFICES 25 West Broadway, New York 7, N. Y. Telephone REctor 2-9690.

BRANCH ADVERTISING OFFICES: Chicago: 308 W. Washington Street, Suite 1413, Chicago 6, Ill. Tel. Randolph 7363. Cleveland: Burdette Phillips, Manager, 405 Erie Bldg., Cleveland, Ohio. Tel. Main 9645. Detroit: Frank Holstein, Manager, 307-8 Boulevard Bldg., Detroit, Mich. Los Angeles: Ralph W. Harker, Manager, 606 South Hill St., Los Angeles 14, Calif. Tel. Tucker 1793. San Francisco: Ralph W. Harker, Manager, 582 Market St., San Francisco 4, Calif. Tel. Garfield 2481.

RADIO-CRAFT, June, 1947, Volume XVIII, No. 9. Published Monthly on 28th of month preceding date of issue. Allow one month for change of address. When ordering a change, please furnish an address stencil impression from a recent wrapper. All communications about subscriptions should be addressed to the Circulation Manager, Radio-Craft, 25 West Broadway, New York 7, N. Y.

SUBSCRIPTION RATES: United States and possessions, Mexico, Central and South American countries, \$2.50 a year; \$4.00 for two years; \$6.00 for three years. Canada, \$3.00 a year; \$5.00 for two years; \$7.50 for three years. All other foreign countries, \$3.25 a year \$5.50 for two years; \$8.25 for three years. Special rates for members of the Armed Forces in U.S., or those addressed by A.P.O. or F.P.O. mail, \$2.00. Entered at Post Office, Springfield, Mass., as second-class matter under the Act of March 3, 1879.

FOREIGN AGENTS: Great Britain: Atlas Publishing and Distributing Co., Ltd., 18 Bride Lane, Fleet St., London E.C.4. Australia: McGill's Agency, 179 Elizabeth Street, Melbourne. France: Brentano's, 37 Avenue de l'Opera, Paris 2e. Holland: Technisch Bureau Van Baerle, Bemelmans & Co., Heemsteedsche Dreef 124, Heemstede. Greece: International Book & News Agency, 17 Amerikis Street, Athens. So. Africa: Central News Agency, Ltd., Cor. Rissik & Commissioner Sts. Johannesburg; 112 Long Street, Capetown; 369 Smith Street, Durban, Natal. Universal Book Agency, 70 Harrison Street, Johannesburg. Middle East: Steimatzky Middle East Agency, Jaffa Road, Jerusalem. India: Magazines Distributors, 5 Bombay Mutual Annexe, Gunbow Street, Fort, Bombay 1.

MAKE MORE MONEY

IN
Radio TELEVISION
& ELECTRONICS

GET THESE 2 BIG BOOKS

FREE!

You men already in Radio know how great the demand is for trained, experienced servicemen, operators and technicians. You know how fast the field is growing and how important it is to keep up with developments—F.M. Receivers, Electronics and Television. You know, too, a fellow cannot learn too much about any industry for **REAL SUCCESS**. Whether you have experience or are merely **INTERESTED** in radio as an amateur, you must recognize the **WONDERFUL OPPORTUNITY** right within your grasp to cash in on your natural abilities. Make them pay dividends. Get into the **EXPERT RADIO SERVICE FIELD**. Be an **F.M. and TELEVISION specialist—OWN A BUSINESS OF YOUR OWN**, if you prefer. Fill out and mail the coupon below for all the details of our plan.

Get the Latest Inside Information—Short Cuts—Trade Secrets by

Here's Just a Few of the Interesting Facts you Learn with the **FREE MANUAL**.

1. Routine for diagnosing Radio Troubles.
2. Preliminary Inspection of Receivers.
3. How to Check Power Supply.
4. How to Identify Various Stages of Receiver.
5. How to Trace the Circuit and Prepare Skeleton Diagram.
6. How to Test and Measure Voltages.
7. How to Test Speaker in Audio Stages.
8. How to Test Detector, I.F., R.F., and Mixer Stages.
9. Complete Reference Table for Quickly Locating Receiver Troubles.

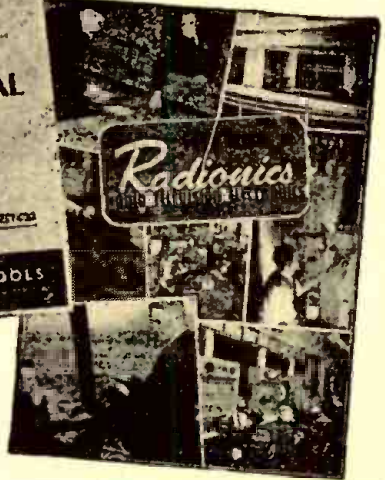
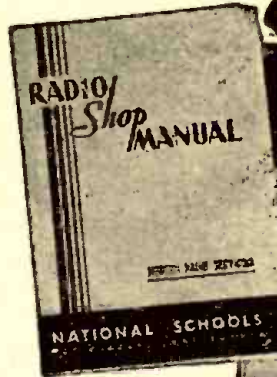

SHOP METHOD HOME TRAINING

FROM A REAL ESTABLISHED RESIDENT SCHOOL

Now the famous National Schools brings its exclusive Shop-Method of training right into your own home. You can learn the most up-to-date, approved projects, systems and circuits step by step in your spare time. This is the sound and practical training you want and need—the development of experienced instructors working with thousands of students right in shops, **NEW F.M. broadcast studios and experimental laboratories of NATIONAL SCHOOLS**—one of the most advanced trade educational centers in the world.



LEARN BY DOING

Work with Real Experimental Equipment Furnished without Extra Cost as Part of Your National Training

Experience is the best teacher. You learn by experience with the exclusive National Shop-Method of Home Training. In the course of your study you actually build various types of receivers—a powerful superheterodyne, a signal generator, an audio oscillator and others—You make tests and conduct experiments that show you the why and how of things. You understand what makes the various elements of electronics operate because you actually see them work for you. Not only do you gain marvelous experience by this method of learning but you receive valuable equipment you will use on the job in the practice of your profession as an electronics expert. Mail the coupon and learn what this means to you.

Send the Coupon and prove to yourself what YOU can do in **RADIO!**

VETERANS

If you qualify for training under G. I. Bill, check the coupon for a Special Bulletin.



Be Sure Of Your Success And Security After the War

Don't let your post-war ambitions lag. Don't let YOUR future depend on others. Build a career for yourself. Never in all history has the returning serviceman, or war worker been confronted with such a great future if he reaches out and grasps it NOW. Here is a new world opening before you. Get ready now while you are still in uniform—while you are on your war job. Then you can soon step into an essential, well paid position or, with little capital, **GET INTO BUSINESS FOR YOURSELF**. It isn't a bit too soon to start now. Radio men are vitally needed. Fill out and mail the coupon immediately and examine the **NATIONAL SHOP METHOD HOME TRAINING COURSE** carefully, without obligation.

FREE LESSON INCLUDED

Examine the exclusive National Shop Method of Home Training. See for yourself how sound and practical it is. Be convinced that you can learn Radio, Electronics, Television—quickly and easily in your spare time. You can't tell until you try. This trial is **ABSOLUTELY FREE**. Fill out the coupon immediately while you are thinking about it and drop it in the mail at once.
 Mail the coupon here for the books that tell you the complete story of the marvelous new system of training in Radio, Electronics and Television. Learn the facts of this exclusive shop-method of home training. See for yourself! **DECIDE FOR YOURSELF!**
 This is the **MODERN SYSTEM OF TRAINING**: it matches the rapid progress constantly being made in Radio, Television and Electronics. It is **TIME TESTED**, too. National Schools has been training men for more than a third of a century. It is the very same training that has helped thousands to more pay and greater opportunity.
 You owe it to yourself—your future—to read the book "Your Future in Radio, Electronics and Television"—FREE to you when you send in the coupon.

NATIONAL SCHOOLS

LOS ANGELES 37, CALIFORNIA EST. 1905



MAIL OPPORTUNITY COUPON FOR QUICK ACTION

National Schools, Dept. 6-RC
 4000 South Figueroa Street, Los Angeles 37, California.

(Mail in envelope or paste on penny post card)

Mail me **FREE** the two books mentioned in your ad, including a sample lesson of your course. I understand no salesman will call on me.

NAME AGE

ADDRESS

CITY ZONE STATE

Check here if Veteran of World War II.



ESSE Specials!

THIS EQUIPMENT HAS BEEN REMOVED FROM SURPLUS AIRCRAFT—AND IS SOLD AS USED



ATTENTION, PROSPECTORS, MINERS, OIL COMPANIES, PLUMBERS, etc. Below is the finest metal detecting mine detector ever constructed . . .

SCR-625 MINE DETECTOR — BRAND NEW Metallic Objects Only

Used by the Army to detect buried metallic mines. Its private use suggests the location of underground or underwater pipes, cables and ore bearing rock, the location of metallic fragments in scrap materials, logs, etc. and the screening of personnel in plants for carrying of metallic objects.

The unit consists of a balanced inductance bridge, a two-tube amp. and a 1,000 cycle oscillator. The presence of metal disturbs the bridge balance, resulting in a volume change of the 1,000 cycle tone. The tubes used are low battery drain types such as 1G6 and 1N5. The circuit may be modified for control of warning signals, stopping of machinery etc. when metal is detected. Operates from two flash light batteries and 103 V. "B" However, a power supply operating from 110 V. may be used. Comes complete with spare tubes, spare resonator and instruction manual — in wooden chest 8 1/2" x 28 1/2" x 16". Weight in operation is 15 lbs. New, complete in original overseas packing container. Originally sold by War Assets for \$166.00.

The U. S. Forestry Service has recommended procedure for using the SCR-625 Mine Detector to find concealed metal in tree logs and other timber products.

Price.....\$79.50 ea.

AN/ART-13 COLLINS AUTOTUNE TRANSMITTER

A modern, compact, lightweight, high-powered transmitter. For frequency range 2-18.1 Mc. on any of its 11 auto tune crystal controlled or master oscillator channels. December Radio News gives conversion details for converting 24 V. DC operation to 117 V. AC. These units removed from planes. Checked and guaranteed. Weight, 67 lbs.

Price.....\$134.50

Complete with dynamotor unit!

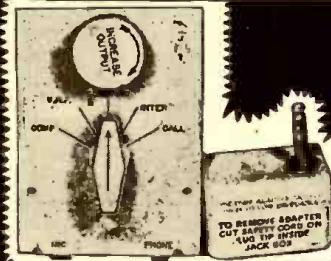

JACK BOX BC-1366

Contains 2-pole 5-position switch, rheostat, two phone jacks, etc. in aluminum case 3 1/4" x 4 3/8" x 2 1/4". Complete with headphone set adapter to match high to low impedance.

Price.....75c

NAVY—CRV-46151 AIRCRAFT RADIO RECEIVER

Four bands, including broadcast (195-9,050 KC.). Circuit is six-tube superheterodyne with mechanical band change or remote operated electrical band change. Remote band change and tuning controls included, making this set readily adaptable to mobile ham use. Powered from self-contained 24 V. DC dynamotor.

The sets are complete with tubes, mounting rack and remote controls.

Price, Including Case.....\$29.75

On orders less than \$10.00 allow additional charge of 25c to cover handling.

BC-433 ADF RECEIVER

Three bands, 200 to 1750 KC. Complete with 17 tubes required and remote control. This set is ideal for conversion to home broadcast receiver, addition to ham shack, etc. Reportedly sold for about \$2,000.00 when brand new.

Price, now.....\$31.50

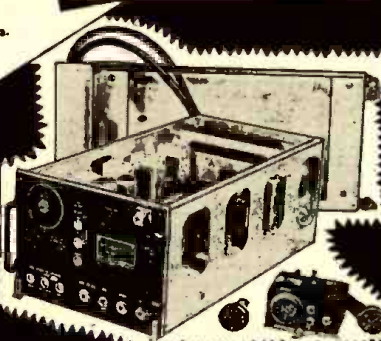

ARC-4 TRANSMITTER AND RECEIVER

Operates on any of its 4 predetermined crystal controlled frequencies in the range of 140 MC. Complete with tubes, remote control, junction box, shock mounting base and connecting plugs. This unit is ideal for amateur UHF or mobile telephone. Operates from self-contained 24 V. DC dynamotor. 12M available upon request.

Price, as described, Including Case.....\$39.75

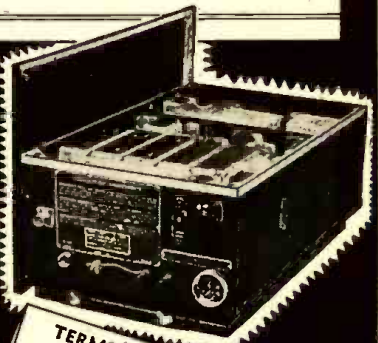

TERMS: CASH WITH ORDER
ON ORDERS LESS THAN \$10.00
ALLOW ADDITIONAL CHARGE
OF 25c TO COVER HANDLING.



ESSE

Radio Company
130 W. New York St. Indianapolis 4, Ind.

TELEVISION-

America's Next Giant Industry?



Billboard Announcing Telecasts of Ball Games in Chicago

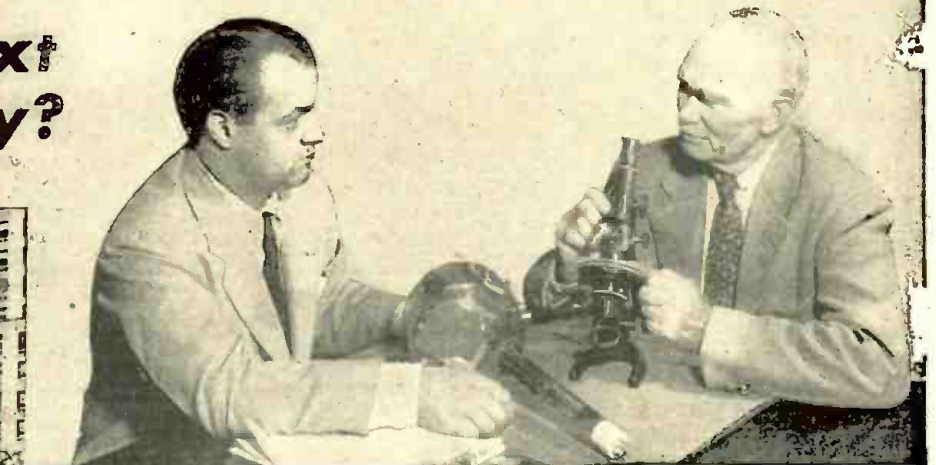

U. A. Sanabria

Dr. Lee deForest

The Men Who Direct American Television

The instructional quality of training is under the constant personal supervision of two internationally known engineers, Mr. U. A. Sanabria, President and Founder of American Television, Inc. and Dr. Lee deForest, the famed inventor of the radio tube.



FREE PRE-ENTRANCE COURSE

A Short Home Study Television Course is available to qualified war veterans who are considering residence training. This course is free of any charge or obligation. Your success with it will help you to learn your own abilities in television. It will also aid us greatly in qualifying you for residence training. Your acceptance of the Home Study course in no way obligates you to enter our residence school. So we urge you to take advantage at once of the very unusual opportunity it offers.

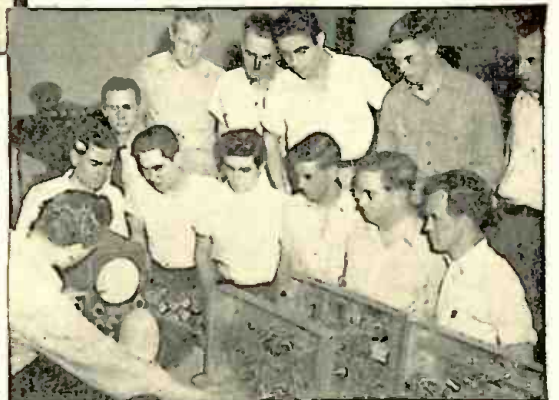

Approved for Veteran Training Under G. I. Bill of Rights

Today, RIGHT NOW, clear and bright pictures of great sports events, as well as other equally interesting programs, are being telecast for the enjoyment of thousands. Television stations in New York, Chicago, Philadelphia, Washington, Detroit, St. Louis and Los Angeles are already operating on regular schedules. Construction has started in several other centers and it is believed that practically every major city in the country will have this wonderful service before the end of 1948.

Who will build, maintain, and operate the new telecast stations? Who will design, produce, install and service the receivers?

Men Must Be Trained for These New Professions

Alert young men with an ambition to grow with television are training now in the greatly enlarged instruction laboratories of American Television, Inc. A wide choice of courses available. Advanced methods and latest obtainable equipment used.

One of Our New Buildings.
Air Conditioned the Year Round.



American Television, Inc.

5050 BROADWAY

CHICAGO 40, ILLINOIS

REQUEST FOR FREE INFORMATION

American Television, Inc., Dept. of Information
5050 Broadway, Chicago 40, Illinois

Please send details of your Television Training.

NAME _____

ADDRESS _____

CITY _____

ZONE _____

STATE _____

I am a veteran

Start your Own RADIO SERVICE SHOP

Choose one of these
3 GREAT NEW DEALS

\$99⁵⁰

\$179⁵⁰

\$350⁰⁰

Includes TEST EQUIPMENT, TUBES, PARTS, TOOLS

3 complete going-in-business packages. (If necessary they can be changed to suit your needs.)

There never was a better opportunity than now to start a profitable business of your own. No fuss, no worry. Here's everything you need. Details upon request. Write, wire or phone!

Featherweight Miniature TEST INSTRUMENTS

Compact — Accurate — Priced Right!

- Jeweled Meter • Range Selector Switch
- All multipliers bridge tested for 1% accuracy
- Zero adjustment—built in batteries
- Molded bakelite case only 3-13/16" x 2-7/8" x 2"

MODEL 451A AC-DC Volt—Ohm—Milliammeter



A dependable instrument of wide utility—sensitivity 1000 ohms per volt. Ranges: Volts AC, DC, and Output Ranges, 0-10/50/100/500/1000; Ohms full scale, 500,000. Ohms center scale, 7200.

NET complete with batteries..... **1490**

MODEL 312 Volt—Ohm—Milliammeter



An economy pocket meter featuring a 2" moving vane meter. Reads: AC-DC volts, 0-25/50/125/250; Mills AC-DC, 0-50; Ohms, 100,000; mfd., .05-15. Jacks provide range selection.

NET Complete with cord and plug..... **675**

FAMOUS "LITTLE TRIPLETTS"

The Little Testers with the big 3" Meters Bakelite cases 3 1/4" x 3 1/2" x 2 1/2" Range selection switch—long, easy to read scales. We made a good buy—here they are at rack-bottom prices—The greatest buy ever offered in precision testing equipment.

Model 650SC - OUTPUT METER

A 4000 ohm constant impedance AC volt meter with ranges of 0-1.5-6-15-60-150 volts. Conversion chart for reading DB level from -10DB to +35 DB. 100 microampere meter. Excellent for receiver alignment, level indicators in recording equipment, general use in electronic apparatus. Regular net 24.50. A "one time only" Special buy at..... **1049**



Model 606B-VOLTAGE TESTER



Checks voltage and polarity. Range: 0-440 AC-DC volts—definite indications for 115, 220, and 440 volt lines. Separate polarized vane for AC or DC indication. Built in test leads. Excellent for checking wiring, fuses, general factory installation and maintenance. Every plant — every electrician needs several at this low price. Regular net 16.67 **895** Special at.....

RADIART AERIALS

The Quality leader • Recognized by everyone • Admiralty brass rods • Triple plated • Permanently rattle proof • Static muffler ball • Polythelene insulated HI Q lead with protective vinylite covering • Supplied with single pin (Motorola) connector and adaptor for bayonet style (Delco and Philco) fittings.



TYPE CF3-63

A two insulator side cowl mount—3 section 63" rod—supplied with 3 insulators and wedge adaptor to fit 95% of all car bodies—complete with 48" lead. **199** List price \$4.95—our price.....

TYPE CFA3-63



All angle cowl or fender mount—A modern Radiart development—fits all body contours, straight or curved, cowl or fender. 3 section 63" rod easily adjusted to vertical without tools—complete with 40" lead. **199** List price \$5.45 we sell for.....

GENERATOR CONDENSERS



PHILCO part No. 61-0177—.5 mfd.—1/4" x 1 1/4"—4" lead-slotted mounting strap for easy installation—Standard Merchandise—not war surplus—Present list price \$1.00. Our special—over 85% off..... **14c**

200 WATT SOLDERING IRON

FAMOUS HEXACON ELECTRIC'S MODEL 201



FEATURES: Full 200 watt replaceable element. 3/8" tinned Copper tip, replaceable. One piece drawn case-gun metal finish.. 6' heavy duty cord—stand included. Comfortable, well balanced handle. Operates on 110 volts—AC or DC. List Price \$8.00 Speed up your heavy work—Save time—save money at..... **369**

OUTPUT TRANSFORMERS

Clean stocks — long leads — mounting feet — made to fit where you need them. For 6FG-6KG—to 4 ohm voice coil—size 2" x 1 1/4" x 1 1/4". 50L-35L6-25L6 to 4 ohm voice coil 1 1/2" x 1 1/4" x 1 1/4". Specify quantity of each type you need at..... **49c**



Order from the Ad
Write - Wire - Phone

PHONO PICKUP CRYSTALS

Standard types—Set Manufacturers close-out—all Guaranteed



Webster F2—Replaces L26-L40-L70 etc.—pin type terminals—1 oz. pressure—1 volt output—5000 cycle cutoff. List price \$5.00—you pay us.... **149**



SHURE P93—W57A—pin type terminals—3/4 oz. pressure—1.6 volt output—6000 cycle cut off. List price \$4.45—our Special..... **198**



Astatic L-70—new postwar design—solder terminals—1/2 oz. pressure—1 volt output—4000 cycle cutoff. List price \$5.55—we quote you... **198**

PHILCO BEAM OF LIGHT

Selenium cell only, no holder, postpaid... (Puts new life into Philco Chargers) Sapphire needle only, no mirror, postpaid..... **120**

ALL RUBBER LAMP CORD



Underwriters Approved brown rubber covered insulated parallel Cord—"rips" apart easily—non fraying—deluxe—way above average quality. 500' Roll..... **989**

MULTI-USE WIRE



Stranded No. 22 tinned wire—glass "ROCKBESTOS" 1000 volt insulation—fireproof aircraft wire—a wartime development—at this low price you can use the best—

100 feet..... **45c** 1000 feet..... **389**

JEWELLED PILOT LIGHT ASSEMBLIES



- Candelabra screw base for 110 volt lamp.
- Mount in 1" hole.
- Lamps removable from front of panel.
- Available marked 1-2-3 or 4 on back of white lens.

YOUR CHOICE net..... **19c**

Include full remittance with orders of \$3.00 or less. Include 25% deposit with all C.O.D. orders of \$3.00 or more. Prices subject to change without notice.

SEND FOR FREE CATALOG

RADIO SUPPLY & ENGINEERING CO., Inc.

125 SELDEN AVE. DETROIT 1, MICH.

**Prepare
NOW**

for a Better Job *in*
the Field of Radio!



**Don't Delay—
Write Today!**

—In This New World of Electronics Better Training Means Better Opportunities!

TODAY, the new war-developed techniques offer greater opportunities than ever existed in the early days of broadcasting! Micro-Wave Relay Systems, Television, FM Broadcasting, Mobile Communication Systems for Trains, Automobiles, Busses, Trucks, many Industrial Applications—these are just a few of the new techniques which offer marvelous, exciting opportunities to you who are alert—and are qualified!

Let Cleveland Institute Take Over Your Personal Up-Grading Problem! Qualified, competent instructors, ample, personalized instructional aids, orderly, progressively arranged study assignments in recognized, approved technical texts—these are only a few of the many superior advantages of CIRE's plan of personalized spare-time home study training for professional self-improvement.

CLEVELAND INSTITUTE COURSES OFFER COMPLETE TECHNICAL TRAINING RANGING FROM LOW-LEVEL TO COLLEGE-LEVEL.

A. Master Course in Radio Communication. Covers complete preparation for broadcast station employment including preparation for FCC License Examinations.

B. Advanced Course in Radio Communication Engineering. A college-level Radio Engineering Course.

C. Specialized Television Engineering. Including post-war Television Techniques.

All Courses Include

The Remarkable Workbooks of Instructional Aids, prepared by the instructing staff of Cleveland Institute.

Choose the course best suited to your needs—Start with the section you are qualified to enter—Use the economical CIRE "Pay-As-You-Go-Plan."

ENROLL FOR INDIVIDUAL SECTIONS OF COURSES, IF YOU PREFER.

If you need only highly specialized training, you can study one or more of the following sections instead of a complete course.

1. Mathematics of Radio.
2. Fundamentals of DC and AC Theory.
3. Essentials of Radio Communication.
4. Communication Networks.
5. Advanced Radio Telephony for the Broadcast Operator.
6. Audio and Radio Components and Systems (Design of Receiver and Transmitter Equipment).

**CLEVELAND INSTITUTE
OF RADIO ELECTRONICS**

Contractors to the Canadian Broadcasting Corporation

RC-6 Terminal Tower
CLEVELAND 13, OHIO

Approved for Training under "G-I Bill of Rights"

(MAIL THIS COUPON)

Cleveland Institute of Radio Electronics, RC-6, Terminal Tower, Cleveland 13, Ohio.
Gentlemen: Please send information about your home courses in Radio Electronics.

NAME I desire training in A B C
 ADDRESS I have had experience in broadcasting servicing
 operating m/s. CAA Army-Navy
 CITY amateur other I am a
 High School Grad. College Degree
 ZONE STATE Check here for Veteran Enrollment Information.

**How To Pass
FCC
LICENSE
EXAMINATIONS**

CLEVELAND INSTITUTE
OF RADIO ELECTRONICS
Terminal Tower Cleveland, Ohio

*Get
your*

FCC Commercial Radio Operators' LICENSE NOW!

IT'S EASY IF YOU FOLLOW OUR PLAN!

Thousands of new jobs are opening up—FM, TELEVISION, MOBILE COMMUNICATIONS SYSTEMS, are only a few of the radio fields which require licensed operators.

TIME IS IMPORTANT TO YOU!

You can get your License quickly with NILSON'S MASTER COURSE in RADIO COMMUNICATION and exclusive CIRE Workbooks of Instructional Aids. Saves you many hours or random, undirected study.

Assures a MINIMUM of time in getting your ticket.
FREE BOOKLET tells you the Government Requirements for all classes of commercial licenses—Sent immediately upon receipt of coupon.

**Don't Delay—
Write Today!**

Approved for Veteran Training under "G-I Bill of Rights"

**CLEVELAND INSTITUTE
OF RADIO ELECTRONICS**

Contractors to the Canadian Broadcasting Corporation

RC-6 Terminal Tower
CLEVELAND 13, OHIO

MAIL THIS COUPON

CLEVELAND INSTITUTE OF RADIO ELECTRONICS
RC-6 Terminal Tower, Cleveland 13, Ohio

Gentlemen: Please send information about your Home Study Course for preparation for FCC Commercial License Examinations (this course does not cover amateur license examinations).

Name.....
 Address.....
 City..... Zone..... State.....
 If a Veteran check here

SPRAGUE TRADING POST

SWAP—BUY OR SELL

FOR SALE—Hallcrafters SX-25 receiver with bass-reflex speaker, \$100; also 50 ft. co-ax cable, \$1.75. L. C. Zaret, 6246 N. Oakley Ave., Chicago, Ill.

WANTED—Circuit diagram for Navy Oaks sonar unit. Have many small parts for sale. Peter Wnukowski, 244 Ridge Ave., Kingston, Pa.

WANTED—The following German tubes: DCH-11; DF-11; DAF-11; DL-11; UY-11; Arthur Hellmann, 15 Argyle Rd., Brooklyn 18, N. Y.

FOR SALE—National 1-10 receiver complete with tubes and power supply, \$40; Geo. E. Anthony, 878 Gilbert St., Columbus 6, Ohio.

WANTED—Messner Pre-aligned tuning unit 13-7616. John Walnwright, Greenmount, Md.

FOR SALE—AC SW-3 complete with coils for 20-40-80 mic. bands, power supply; also good 50-watt rig, 6V8 xtal osc., pair 6L6's final, 40 & 80 mtr. xtals, power supply, F. Bou W3ESX, 3131 N. Percy St., Philadelphia 33, Pa.

WANTED—Small relays to operate at 1 mil. or less; tiny motors; tiny Thyratrons, sub-miniature tube sockets 5AX, 6AX, 7AX; tiny I.F. caps, freq. unfilmorants; buy or swap, L. Kursimer, 1945 Franklin Circle, Hollywood 28, Calif.

TRADE—Have misc. radio parts, new and used in trade for mimeograph machine, legal size. Ed. Howell, Rt. 2, Dillon, S. C.

SELL OR SWAP—Model airplane and motor; also parts from Eklon power unit; a few radio parts; some midjet tubes; 6C4, 6AK5, 6AQ6, 11m Rosche, 3215 Davo N. C., Cedar Rapids, Iowa.

WANTED—Hallcrafters SX-25 Super Defiant, new or used. State price. Jose Yaquez, 2610 S. 9th St., Philadelphia, Pa.

FOR SALE—Ultra portable "Lucy" receiver, without BFO, completely wired, with speaker transformer, including Navy phones, 2.5 to 12.5 mc., \$20. Father Geffen, Norwalk, Conn.

WANTED—Technical books or ham gear. Cash or trade. Eddie Howell, 501 W. Harden, Graham, N. C.

WANTED—Army and Navy clocks, 12 or 24 hour; chronometer. Cash or trade radio and amateur radio equipment. Wm. Hansen, 165 Silverbrook Ave., Niles, Mich.

WANTED—Cove practice machine with tapes, continental Morse, condition immaculate. Cash. Fix-it Shop, Bird Island, Minn.

WANTED—Instruction manuals on Army SCR-274N and SCR-322; also want to buy freq. meter RC-221. AL, AK, or AR. J. H. Oxford, Southern Air Services, P.O. Box 290, Memphis 1, Tenn.

WANTED—Speed key (bug) electronic or mechanical. In good condition. J. Jorkowski, Horseneck Rd., Caldwell, N. J.



Replacing Wets IS ONLY THE BEGINNING!

Sprague Type WR Capacitors are especially designed can type dry electrolytics having very high voltage formation. They'll stand high surges or peak voltages. They'll handle the strong a-c ripples that often cause ordinary 450v. dry electrolytic capacitors to break down. In short, they're absolutely "tops" for replacing ANY wet electrolytic capacitor in a radio set — and a lot more besides! Actually, they're "just what the doctor ordered" for JUKE BOXES, television sets or any application where ordinary condensers have the annoying habit of breaking down to cause a whale of a lot of trouble — not to mention dissatisfied customers. Buy them from Sprague distributors in 8, 16 and 25 mfd. sizes — to fit standard "wet" mounting holes — and CONSERVATIVELY rated at 500v. D.C. working voltage and 600v. surge! Ask for Sprague Type WR!

SELL OR SWAP—Several home-study radio courses; commercial, sample multiple choice questions and answers for radio phone 1st class, and radio-telegraph 2nd class 10 for \$10. Want Rider manuals, photo enlarger, commercial x'mitter, W6WJ, Box 1298, Hollywood 28, Calif.

SELL OR SWAP—Instructograph, 10 tapes, like new; Federal 219-enlarger, excellent condition. Want receiver, good condition. B. Simon W2DUN, 7 Madison St., Port Washington, N. Y.

FOR SALE—New Amertran power x'former PP-25A, 100, 110, 115, 120 V. pri., 600 V. sec. c.t., 4-3.75 V. windings at 1.25 amp. each, high-voltage winding at 120 amp., 60 cy. Fred Marrow, 3495 Broadway, New York 31, N. Y.

WANTED—Dead or alive short-wave receiver; volume expander; large speaker with tweeters or Jensen Co-axial or similar speakers. Have car radios, manuals and some testers—what do you need? Glenn Watt, Chanute, Kans.

WANTED—BC-610 converted for 10-mtr. Have misc. radio parts and supplies. E. Howell, 501 W. Harden St., Graham, N. C.

SWAP—Mar. 1932—Dec. 1946 QST's for useful surplus. A. J. Urban, 283 Garden St., Hartford 5, Conn.

FOR SALE—Used 14-tube Navy type RBS receiver a-c operation, complete with instruction book. Covers 2-20 mc., in 4 hands, r.f. and a.f. level control, BFO, noise limiter, precision dial, tuned plate r.f. stage, link coupled to mixer, \$75 (o.b. J. B. Fell, W7IKE, 517 Ave. G, Billings, Mont.

WANTED—Any good ham x'mitter like RC-610; HT-4E or HT-9, have new test equipment for part trade. Donald Clark, Blackfoot Radio Shop, Blackfoot, Idaho.

URGENTLY NEEDED—Auburn (chassis 441) or r.f. or oscillator coil for same; Auburn (chassis 320) or i.f. transformers for same. Cash or swap. Lewis W. Robinson, 3781 3rd Ave., New York 30, N. Y.

FOR SALE—S-38 in perfect condition, \$35; also S-41 W., L. Colby, 122 Main St. Oswego, N. Y.

SWAP—LanKines pocket watch, \$125 value for good communications receiver equal value; also Webster 56 record changer for ham equipment, Art Meek, 1430 Elton Rd., Jennings, La.

FOR SALE—Collins AN/ART-13 x'mitter, less tubes, power supply, calibration x'tal, \$100; also 3 CFI units for AN/ART-13, \$1.50 ea.; dynamotor 28 V., 32 amp., d-c/750 V., 0.35 amp., 400 V., 0.75 amp., a-c \$5. E. Lovick, 907 W. Nevada, Urbana, Ill.

WANTED—New or used Stancor transformers A4206; A4404; portable recorder with play back. Will pay top price. Riley Parsons W2SHR, Raquette Lake, N. Y.

WANTED—Hallcrafters short-wave receiver in good condition. Have electronic volt-ohm-milliammeter, excellent condition for trade. Write stating price, etc. Paul Cowins, Blackburn St., Lynchburg, Va.

WANTED—Used amateur x'mitter in good condition. Will pay in monthly installments. Will furnish bank and other references. Louis A. Vas, Rt. 4, Middle Rd., Ashtabula, Ohio.

FOR SALE—Gordon A-C turntable 10 to 100 rpm and magnetic pickup; radar motor 28 V. D-C or 110 V. A-C, 12,000 rpm, new; Shure P-935 and Astatic L-75-S, E. Colo. 215 N. Lorel Ave., Chicago 44, Ill.

SELL OR SWAP—Mercury 35 mm. camera, F3.5, 1/1000 sec. 18" to infini., with leather case, sync. flash gun, attached light meter. Sell for \$50, or trade for new BC-975-E trans., HC-348 receiver, or BC-654-A Rec.—Trans. G. E. Oden, 217 Marshall St., Wauseon, Ohio.

FOR SALE—2 307-A's, 3 sockets, \$5; Simpson 0-3 r.f. meter, \$2.75; 2-832's, 2 sockets, \$7.25; 7010 kc. xtal, \$2.25; 8155-715 kc. xtal, \$2.25; 28 V. dynamotor unit, \$6. Ralph N. Huse, 820 Hunt Ave., Sumner, Wash.

SWAP—1 ea. 611-F walkie-talkie (\$875 kc.), new, for HC-348-Q receiver. Need not be converted. State difference in price, if any. Also want conversion data for BC-457, 458A series. Francis Goresen, 2224 W. Adams St., Chicago, Ill.

SELL OR SWAP—Hallcrafters SX-28-A receiver complete with speaker and cabinet. Will trade for Speed Graphic 4 x 5 or 3 1/2 x 4 1/2 complete. RCA TMY 87C sig. gen., Rider's manuals 1 & 2, Abbott transceiver with pwr. pk., 2 mtra. M. J. Curley Jr., 412 Forest Ave., W.B. S.I. #1, New York, N. Y.

FOR SALE—Up to 30 lbs. radio parts, i.f., r.f. coils, transformers, speakers, etc. per package \$3, as long as they last. You pay postage. Ruzicka, 824 17th Ave., Cedar Rapids, Iowa.

FOR SALE—Messner 150-B transmitter, complete with Messner sig. shifter, key, mike and spare parts. Operates on 80-40-20-11-10 mtrs. H-2129X receiver. Both used less than 50 logged hours, \$450, f.o.b. WSHGF, 720 W. Kloberg, Kingsville, Texas.

FOR SALE—Hallcrafters FM-AM 8-87 VHF, 130-210 mc. Thrift Appliances, 1831 Southern Blvd., Bronx 60, N. Y.

FOR SALE—German radio, in good condition, looks like small suitcase, parts can be substituted as well as tubes. A-C D-C, has tone control, 3-band switch, phonograph amplifier. Made by Nora Radio Corp. 810. D. W. Andrews, Box 105, Kingfish, Okla.

FOR SALE—New 4-band Hallcrafters marine transceiver, 13 tubes, 30-watts, 1651 kc. to 2800 kc., \$125; 3 Motorola 30D transmitters, used, with tubes, dynamotor for 6V. operation, \$25 each, 8 for \$65. Robert Skell, 510 Castano Ave., San Antonio 2, Texas.

SELL OR SWAP—Back issues QST: June-Dec. '33; Jan.-Dec. '34; Jan.-Dec. except Sept. '35; Jan.-Dec. '36; Jan.-May, '37; type 841 tube. Want misc. parts, tubes, etc. Carl England, Jr., 50 Lyme Rd., Hanover, N. H.

SELL OR SWAP—New 14-watt p.a. system using 6X4, 6S7, 6Y3G, Pp 8V6's. Phone ton with Shure Glider pick-up, 12" 18-watt Utah p.m. speaker, floor mike stand. Cash or trade for "scope or ham eqpt. T. J. Erwin, 3735 Milwaukee Ave., Chicago 41, Ill.

FOR SALE—Western motors 301; transmitting condensers; transformers; other supplies; Collins transmitter 3-A, \$175. Write for list. Leo F. Kersey, White Sulphur Springs, W. Va.

FOR SALE—Handle-talkie, complete with tubes, coils, xtals, mike, receiver. No cases, \$30 pair. Portable amplifier 15-watt complete with 12" Jensen Speaker, 6 tubes, 2 inputs, tone control, \$35. H. W. Merideth, 1432 Granville Ave., Chicago 26, Ill.

FOR SALE—Complete sets dating back 10 yrs.; QST; Electronics; I.R.E.; Communications magazines. All perfect, intact. P. Rosenblatt W2AKP, Box 805, Etobicoke, N. J.

YOUR OWN AD RUN HERE FREE

The Sprague Trading Post is a free advertising service for the benefit of our radio friends. Providing only that it fits in with the spirit of this service, we'll gladly run your own ad in the first available issue of one of the six radio magazines in which this feature appears. Write CAREFULLY or print. Hold it to 40 words or less. Confine it

to radio subjects. Make sure your meaning is clear. No commercial advertising or the offering of merchandise to the highest bidder is acceptable. Sprague, of course, assumes no responsibility in connection with merchandise bought or sold through these columns or for the resulting transactions.

Send your ad to
DEPT. RC-67 SPRAGUE PRODUCTS COMPANY

North Adams, Mass.

(Jobbing distributing organization for products of the Sprague Electric Co.)

ASK FOR SPRAGUE CAPACITORS and *KOOLOHM RESISTORS by name!

*Trademark Reg. U.S. Pat. Off.

FM AND ALTITUDE

FM Race for Altitude Is On

By HUGO GERNSBACK

FREQUENCY MODULATION, which before the war had already made excellent progress, is now going ahead in earnest with greater and more rapid strides than ever.

According to the latest reports of the Federal Communications Commission, there are now in operation more than 200 FM transmitters in the U. S. against over 1,000 AM transmitters. The FCC estimates that by the end of this year there will be 700 FM transmitting stations on the air. How many more there will be next year is not possible to predict exactly at this moment.

That FM is going ahead by leaps and bounds is further attested to by the Radio Manufacturers' Association, which in a statement, as we go to press, estimates that the output of FM receivers for the year 1947 will be between 1,800,000 and 2,100,000 units.

We have mentioned a number of times in this space that to satisfactorily blanket the United States with FM transmitters would require a minimum of 1,500 stations against the 1,000 odd AM transmitters. As is well known, due to the shorter wave lengths used by FM, the range of the transmitter is dependent on its horizon. FM transmission normally does not extend much beyond this point, and if there is FM reception much beyond the horizon, it is a freak action. Thus the average FM transmitting tower of about 500 to 600 feet covers a satisfactory range of only about 35 miles.

If a given FM transmitter wishes to increase its range, there is at present only one way to do so. The transmitter has to gain altitude—its antenna must go higher. The higher the transmitter, the greater the coverage. For this reason, all FM transmitters strive for as high an elevation as possible. Thus, in New York City we have an FM transmitter on top of the 1,250-foot Empire State Building. This immediately gives a larger coverage for the transmitter which now can reach an audience within approximately a 55-mile radius from the transmitter.

Wherever there is a high natural elevation, the FM engineers are anxious to locate on it, if at all practical. For example, in New England we have an FM Station on Mt. Washington where its transmitter is at an elevation of 6,288 feet. This gives the station a transmitting radius of 120 miles.

It is probable that the United States will soon be dotted with FM stations on many mountain tops. We give here a short tabulation of a few high points in the United States and their location, showing where eventually FM transmitters might be located. The radius of transmission is also given.

HIGH MOUNTAINS IN U.S.

	Elevation Ft.	Has FM Station	FM Average Range
Mt. Washington, N. H.	6,288	yes	120 miles
Mt. Davis, Pa.	3,213		90 miles
Mt. Mitchell, N. C.	6,684	yes	130 miles
Cheaha Mountain, Ala.	2,407		85 miles

Granite Peak, Mont.	12,850	170 miles
Mt. Elbert, Colo.	14,431	180 miles
Mt. Whitney, Calif.	14,495	180 miles
Mt. Rainier, Wash.	14,408	180 miles

This, of course, is only a theoretical evaluation. In some cases it will not be expedient to place transmitters on these or other high peaks, for the following considerations:

It is one thing to get altitude for a transmitter but quite another thing to place it in a practical and an economical location. Areas around many mountain peaks are often sparsely inhabited, to such an extent that no one would wish to build an expensive FM station just for the privilege of transmitting to a few thousand listeners. As a rule, the higher and more elevated the location, the more extensive the mountain range and the sparser the population.

Other factors also make it undesirable or unwise to place transmitters at extreme altitudes. First, we may have difficulty in reaching the peak which may be snow- and ice-bound over large parts of the year. Second, there is the high cost of erecting transmitters on such uninhabitable and difficult elevations.

It would therefore seem that extremely high mountainous regions will not prove attractive for FM transmitters except under exceptional and special conditions.

There are other solutions to the problem. One of the most spectacular will be the erection of extremely high steel towers in various parts of the country. Already, Station KRNT of Des Moines, Iowa, is planning a tower 1,530 feet high—280 feet higher than the Empire State Building. This, indeed, would make it the highest man-made structure in the world. Even higher towers than this can be constructed, if there is a demand for them.

There is no technical reason why towers of this type, even several times the height of the Empire State Building, cannot be erected, if the owners are willing to pay the price. Needless to say, such towers would be extremely expensive, but if a much larger territory can be covered by the FM transmitter—particularly in a populous district—it might pay to do so.

It will be noted that whereas the average broadcast AM transmitter mast usually runs only a few hundred feet high, the average FM transmitter antenna already runs from 600 to 800 feet, and this spread between their heights may be expected to increase.

High mountainous elevations, high man-made towers are not the sole solution to the FM altitude problem. A year ago the Westinghouse Electric & Manufacturing Corporation advanced a plan whereby the entire United States could be covered by a few large airplanes circling overhead constantly at a high elevation—five and three quarters miles up. Each plane thus would cover a radius of 200 miles. This scheme (in conjunction with television) the sponsors term stratovision. This proposal is as yet in its developing stage. (Continued on page 74)

RADIO-ELECTRONICS

Items Interesting to

RAILROAD RADIO takes on a new meaning with the introduction of individual speakers for passengers, announced last month by the Budd Co. Their new passenger coaches are furnished with individual rubber-embedded speakers in the headrests of the seats. Since the speakers are placed at ear level low volume is ample for comfortable reception, and passengers in adjoining seats may listen to different programs.

The speakers are connected to a central receiving unit which permits passengers to select one of several programs with a multiple switch on the arm of the seat. Besides having a num-



Controls of the railroad radio sets are mounted in the arms of the seats. Below—how the speakers are installed in cushions.

FM IN BRITAIN takes its first step with the announcement last month that the Marconi company is to supply a 25-kilowatt frequency-modulated broadcast transmitter to the BBC. This is expected to be used on a regular service rather than an experimental basis.

of the four stations, then, in company with United States deputy marshals, entered the four homes at the same instant. The transmitting equipment was found in all cases.

Three were found in possession of active transmitters. The fourth station had been closed down by order of the operator's mother, who had told her son to store the equipment in the attic till she could ascertain whether or not he required a license to operate it.

The boys, in view of their youth and ignorance of the possible serious consequences of their activity, were paroled by the United States attorney in the custody of their parents.

AMATEURS of the world will now form an unofficial arm of the United Nations, following an agreement signed last month between the assistant secretary-general of the United Nations organization and George W. Bailey, secretary of the International Amateur Radio Union.

Chief duty of the amateurs will be to compile reports on the reception and effectiveness of United Nations radio broadcasts to various parts of the world. They will also handle certain news broadcasts and other noncommercial point-to-point traffic for the UN, and will also take part in discussions on United Nations topics.

Radio amateurs who take part in the new net will be licensed as special United Nations Amateur Radio Aides. Details of the plan are being worked out by a four-man board, composed of Brigadier General F. E. Stoner, chief communications engineer for the United Nations, Peter Ayles, director of the radio division of the Department of Public Information, Kenneth B. Warner, secretary of the American Radio Relay League, and Francis E. Handy, the League's communications manager.

FM ALLOCATIONS are expected to be revised drastically following the hearings of May 8 and 9. The Federal Communications Commission proposes that stations be spaced four channels apart, because of interference in some areas where stations are working with less separation. Even where stations are two channels apart, receivers in areas near a number of FM stations suddenly jump from one station to another.

The FCC recognizes that the difficulty is to some extent due to receiver design, pointing out that operation on alternate channels "results in interference in many of the receivers being produced at the present time." Thus it appears that as more is learned about the design of high-frequency receiving circuits, it will be possible to allocate the channels now to be used as buffers.

ber of radio programs on tap, two programs of recorded music from a wire recording unit will also be available.

The same principle of selective listening is being used in the Rock Island Line's *Golden Rocket*, in which several low-powered speakers are mounted in the ceiling of each car. The speakers cover only a small space below them; thus several programs can be received without interference at different points in the same car.

FM RELAYING without special wire lines or relay stations was demonstrated last month at the first meeting of the newly-formed Frequency Modulation Association. The program originated in a small studio in Yonkers, N. Y., from which it was sent by a low-powered transmitter to Major Armstrong's station at Alpine, a few miles away. FM station WBCA, Schenectady, simply tuned in the program and rebroadcast it for the benefit of the FM conference meeting, which was in session in the Ten Eyck Hotel in nearby Albany.

Major Armstrong pointed out in a speech that FM's greater freedom from fading and interference makes it possible for one station to pick up a program from another in what he called "the chain reaction" without the help of expensive wire lines. It was stated that a chain of stations extending, for example, the full length of the Atlantic Coast could pass on the signals from one to the other, and it was hinted that a transcontinental network might be attempted in the near future.

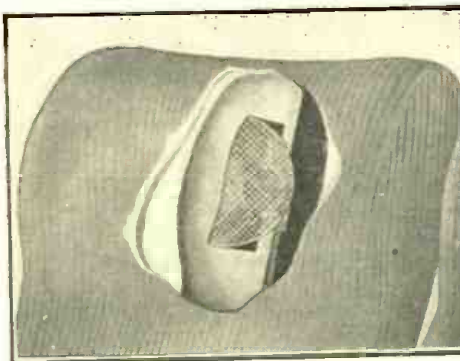

SHIP RADAR will be made more effective by new microwave "lighthouses," General Electric reveals. A unit tested last month at New London, Connecticut, sends waves in all directions at a frequency of 3200 megacycles. These are picked up by the ship's radar, appearing on the screen as a very bright ray which shows the exact position of the beacon with respect to the ship.

It is expected that the microwave units will be installed in lighthouses. Skippers can then use the radar signals in fogs which render the light invisible. In either fog or clear weather, they also provide a useful distance indication not obtainable directly from a simple light.

ILLEGAL BROADCASTERS who operated a "network" of four stations found themselves in the hands of the United States Government last month. The broadcasts, of phonograph records interspersed with musical criticism and wisecracking in the best "disc-jockey" tradition, proved to have come from the transmitters of four Summit, N. J., high-school boys.

Receiving complaints of interference on airway and marine safety frequencies, FCC engineers quietly located each

MONTHLY REVIEW

the Radio Technician

U.S. SHORTWAVE broadcast activity runs second to that of Great Britain, the State Department revealed last month. According to a survey made by the Department, Britain used 16.5 percent of the total broadcasting time for the world and the United States air activity accounted for 9.2 percent of the time.

The third country was Soviet Russia, with 6 percent. France was fourth with 3.8 percent. Broadcasts from British stations were in 46 languages, while American broadcasts were beamed out in 24, with 3 more to be added shortly, according to the report.

SUBMARINE TELEVISION was successfully demonstrated for the first time last month when a broadcast was made from the *USS Trumpetfish* at the Brooklyn Navy Yard.

The ship's maneuvers were covered by Image Orthicon cameras as it submerged, conducted a mock torpedo attack, and finally surfaced. The program was broadcast over NBC's station WNBT, in New York, and carried by co-axial cable to Philadelphia, Schenectady and Washington, from which cities it was broadcast by WPTZ, WRGB and WTTG respectively.

NETWORK FM on a regular basis was introduced by the Army Air Forces Band in a special series of 7 weekly concerts which began early in April. The broadcasts originated at WASH in Washington and were relayed by land lines to Major Armstrong's W2XMN-W2XEA at Alpine, New Jersey. The programs were then picked up by radio by stations WBCA in Schenectady and WDRC-FM in Hartford, Connecticut; WGTR in Paxton, Mass; WBIB, New Haven, Conn.; WIZZ at Wilkes-Barre, Penna.; and WMNE, Mt. Washington, N. H.

The FM signals were also carried by wire to Rochester and Buffalo, from which they were picked up during one or more of the weekly programs by a number of stations. Thus the programs were heard in Syracuse, Utica and Hornell, and in Cambridge, Mass. The series ended May 7, after having broadcast weekly for seven weeks. Fifteen stations formed part of the network for one or more broadcasts.

RADIO RECEIVERS in the United States homes have reached the number of 52,000,000, the Columbia Broadcasting System reported last month. This figure excludes portables as well as automobile and other types which are not strictly home receivers.

One in every 5 families bought a radio in 1946, bringing the number of radio homes to 35,900,000. One-third of all U.S. homes had more than one radio.

COLOR TELEVISION on a 7½-by-10-foot theater screen was shown publicly for the first time in Philadelphia, April 30, by Radio Corporation of America, in a demonstration of its all-electronic color television system at The Franklin Institute. Color motion picture films and slides were projected.

Dr. V. K. Zworykin, Vice-President and Technical Consultant of the RCA Laboratories Division, who demonstrated the new system to illustrate his address: "All-Electronic Color Television" before the Institute, disclosed that the pick-up unit used in the demonstration incorporates the electronic "flying spot" which has been under development for nearly ten years. In this system, he explained, the flying spot of light is created on the screen of the kinescope by the electron scanning beam.

The light from this spot is projected through color slides or films, scanning the entire surface of the scene or object, point by point. As the light beam, then tinted with color, emerges from the film or slide, it passes through a series of filters which separate respectively the red, green and blue portions of the color in the beam.

Each color then is reflected into photocells which change the light values into electrical signals for transmission to the receiver. The flying spot method, he added, assures perfect picture registration by permitting the transmission of the three color values of each picture element simultaneously.

At a press preview before the Institute meeting, correspondents asked a number of searching questions about the possible effects of large-screen television on the present moving-picture theaters.

In reply, David Sarnoff, president of RCA, stated that as opera and the concert hall had found that radio helped rather than harmed them, the moving picture industry might find television a great aid. The moving picture industry, he commented, had not been responsible for the introduction of the talkies, which came from the electronic industry. Possibly the moving picture industry people today are not fully alive to the possibilities of television, he suggested.

WORLD'S HIGHEST STRUCTURE is to be an FM radio tower, it was announced last month by Phil Hoffman, manager of Radio KRNT, Des Moines, Iowa. Construction of the tower depends on approval of the station's application for a construction permit.

The new tower will be 280 feet higher

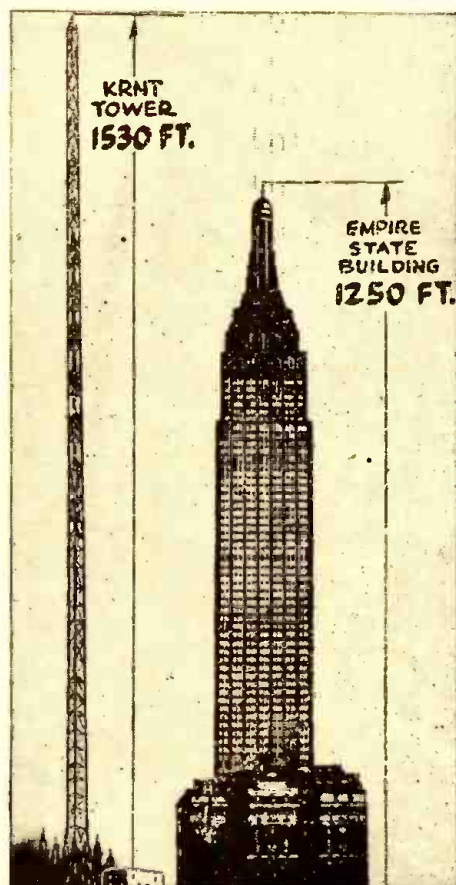

The KRNT tower and the Empire State Building, present holder of the height title. Broadcasts from it are expected to have a range of more than 120 miles, if the full authorized power of 157,000 watts is used.

The station is owned by the Cowles Broadcasting Co., already owners of the highest radio tower in the world—the 927-foot mast of AM station WNAX at Yankton, South Dakota, which has been in operation more than three years.

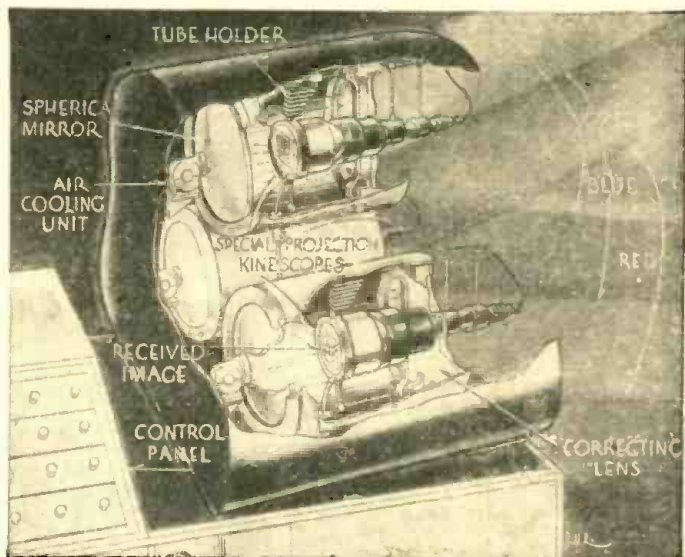

A cutaway drawing of RCA's large-screen color television projector.

COLOR

TELEVISION

By
H. W. SECOR

PART 1

TELEVISION images in natural colors appeal strongly to the imagination of the radio public. It is not easy for the layman to understand why it is so much more difficult to reproduce pictures in color than in black and white. That difficulty does exist, but several means of surmounting it have been proposed and at least partly developed.

To begin with, stations transmitting color television images require a much wider frequency band than black and white (B & W) images. The present B & W pictures occupy a band only 6 mc wide, while 14.5 mc is necessary for the simultaneous (color) system and 16 mc for the sequential (color) transmissions.

The cost of color television receivers would be about *twice* that of B & W sets, according to engineers' estimates.

One strong point in favor of color

television is that the same apparent definition is attainable with a smaller number of lines. For example, with the present 525-line image used in the sequential system (color image) the same apparent definition is obtained as when using 900 lines in a black and white image (as explained in Dr. Peter Goldmark's [CBS] report presented to the Federal Communications Commission).

The two principal methods so far demonstrated for producing color television are RCA's simultaneous system and the CBS sequential method. In the *simultaneous* system all 3 basic colors (red, blue, and green) are transmitted at the same time; in the *sequential* plan the 3 colors are sent one after the other.

The Columbia Broadcasting System's sequential method has been tested experimentally for a period of about three years at a cost of \$2,000,000.

This extensively demonstrated system transmits the 3 basic colors (red, blue, and green) one after the other. In picking up a *live* subject before the camera at the transmitter, the scene is brightly illuminated and an orthicon tube scans the scene through a revolving color filter. See Fig. 1-a. The images are progressively transmitted as black and

white signals over a carrier of suitable width. Color is finally restored to the reconstructed image at the receiver, by spinning a second color filter in front of the picture tube. The rotating color filters at the transmitter and the receiver must revolve in perfect synchronism; not only must the speed of both discs be identical, but they must be *in phase*. When the red filter is before the image reflected into the orthicon tube at the transmitter, the red filter must be in front of the image at the receiver. Perfect registering of the two color filters is secured by transmitting a synchronizing pulse or signal at regular intervals. This has no effect on the picture.

One 16-mc carrier (see Fig. 2-a) is used to transmit the 3 colors in the sequential system. One color follows another in rapid sequence. In many of the CBS tests the sound was transmitted by injecting FM bursts or pulses on the picture signal carrier, without interfering with the image transmission. (Later tests as reported by Dr. Goldmark, have indicated that it is preferable to transmit the sound on a separate subcarrier. One of the advantages of the separate sound transmission is a greater signal-to-noise ratio under all conditions.)

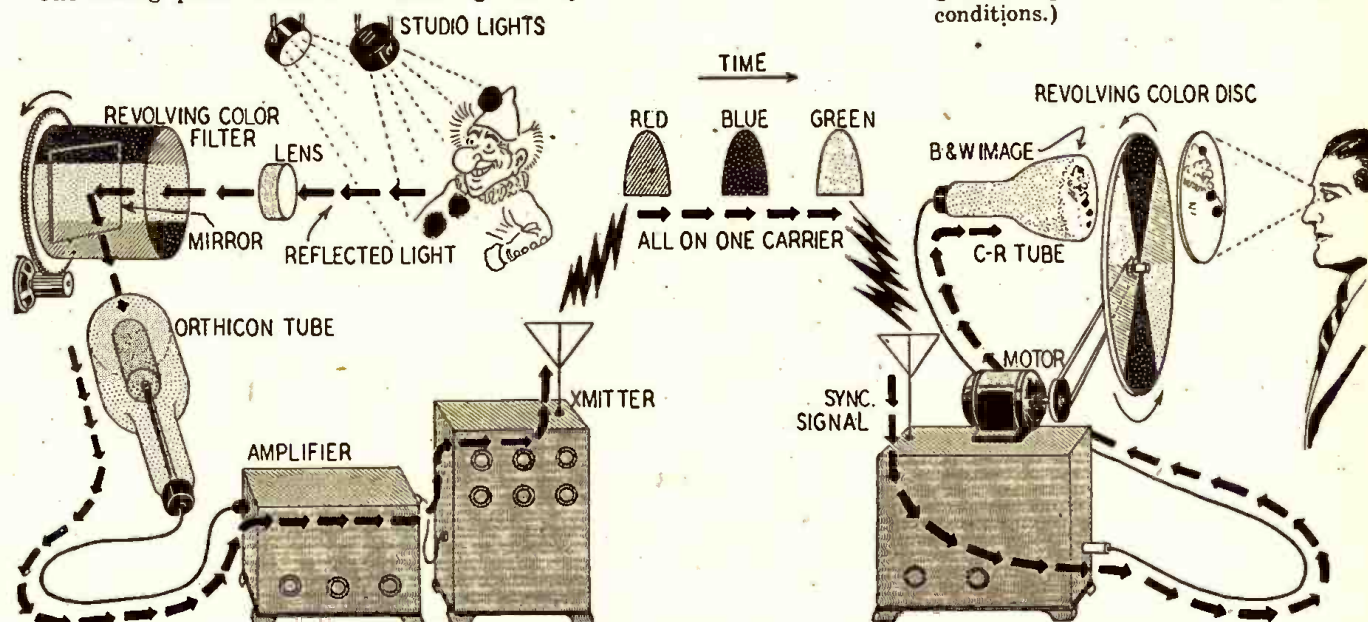

Fig. 1-a—Operations in sequential color television, from subject to viewer. The three colors on carrier follow each other in time.

The sequential system images are transmitted at present with 525 lines and 48 frames per second. The successive color tone images follow one another so rapidly that when they are superimposed on one another at the receiver, they produce a satisfactory color image, similar to that scanned by the camera at the transmitter.

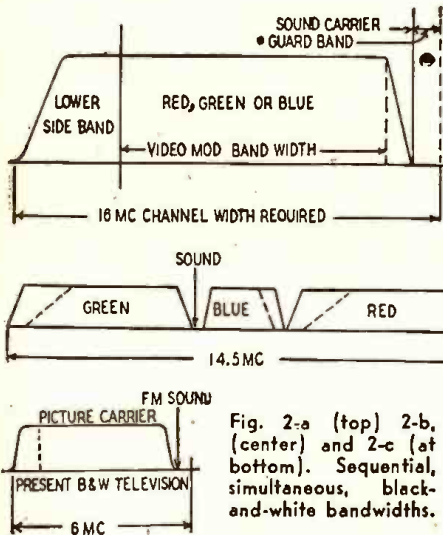

Fig. 2-a (top) 2-b, (center) and 2-c (at bottom). Sequential, simultaneous, black-and-white bandwidths.

The method of scanning the odd and even lines of the image progressively is shown in Fig. 3. At 48 color frames per second, each color scanning will occupy 1/144 second. Six color fields are shown in progressive scanning sequence. First the odd lines are scanned for red (by the red filter) in 1/144 second; next the even lines are scanned for blue. Third, the odd lines are scanned for green. In the fourth color field the even lines are scanned for red, in the fifth the odd lines are scanned for blue, and in the sixth field the even lines are scanned for green.

A complete color picture takes 1/24 second, as the diagram shows. This value was chosen as a happy medium—too low a number of pictures per second

introduces an objectionable flicker; too many pictures per second unduly increases the carrier band width required.

Images with 525 lines have been found fairly satisfactory in the tests and demonstrations made by CBS; increase in detail has not been found to be in proportion to increase in the number of lines employed. Besides, as the lineage is increased, carrier band width goes up proportionately, thus reducing the number of stations that can operate in an assigned band.

Photos A and B show the CBS color television receiver; a diagram of the receiver appears in Fig. 4. This set is arranged for *diplex* (combination video and sound) reception. A color synchronizing separator amplifier is used to maintain the color disc motor in perfect step. The balance of the components corresponds to those found in the present black and white receivers.

One of the criticisms of the sequential receiver has been that it could not pick up B & W images by stations now on the air. The

CBS report shows a *dual-band* CBS receiver that can receive both color images on the new u.h.f (480-920 mc) band and B & W pictures on the low-frequency (40-220 mc) band, by the addition of *four tubes*. A later circuit for a dual-band receiver submitted by Dr. Goldmark permits the reception of color and B & W images *without the addition of any tubes*. Suitable ganged switches are provided for changing the set for receiving either color or black and white pictures.

It is interesting to note that B & W images can be reproduced on the tube used for color images. *If the color disc is removed, a black and white image is observed on the screen of the cathode-ray tube.*

The size of the color image on the



Photo A—Color television receiver by CBS.

sequential receiver demonstrated by CBS was 7 1/2 x 10 inches, the picture being magnified about 40 percent by a

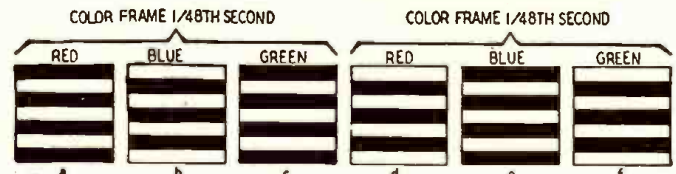

Fig. 3—The color interlacing method used in sequential scanning.

lens placed in front of the revolving color filter. The standard direct-viewing model color receiver (CBS sequential) employs 31 tubes, with a 10-inch picture tube. (The image size is 7 1/2 x 10 inches.) Larger images, measuring 15 1/2 by 21 inches, have been produced by a *projection-type* receiver (see Photo C and Fig. 5) utilizing a Schmidt optical system with a *truncated cone* revolving color filter. A recent model of such a receiver produced color images nearly the same size and used but 34 tubes.

(Continued on page 40)

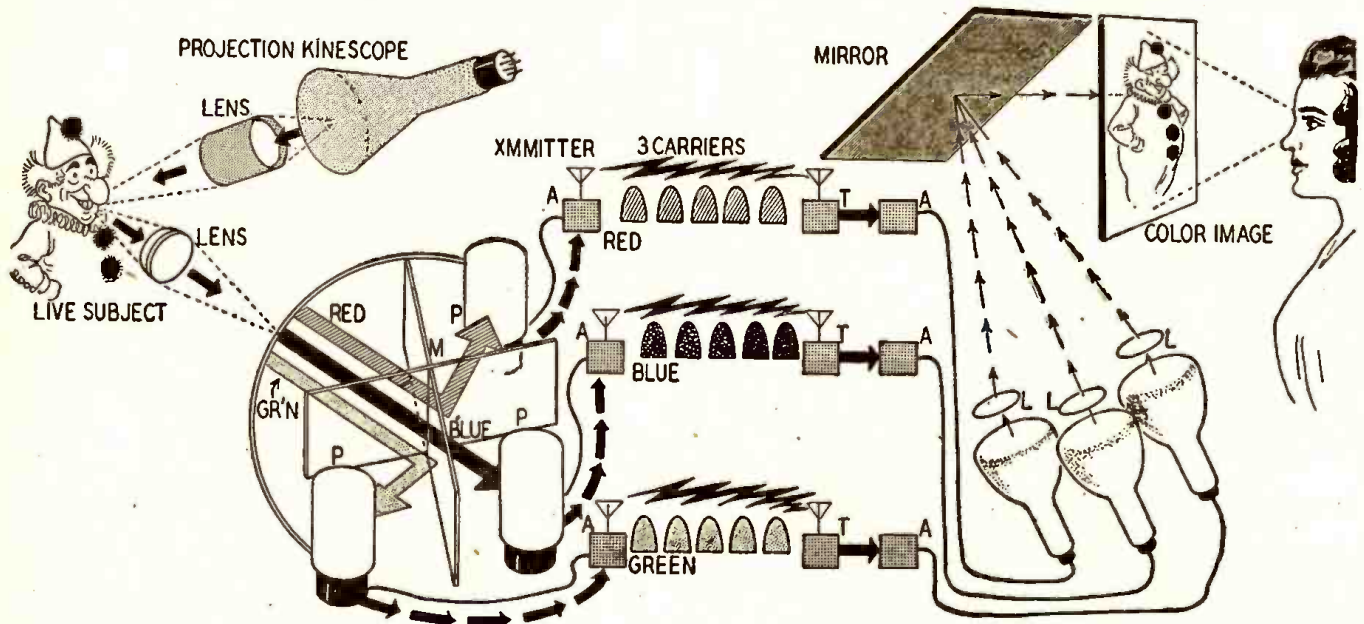

Fig. 1-b—The simultaneous system of color television. Light from the subject is split and transmitted on three adjacent carriers.

Pioneer Atom Splitter

ELECTRONICS has played and is playing so great a role in nuclear research that it is impossible really to separate electronics and nucleonics. Thus it is not surprising to see on our cover one of the world's most distinguished atomic physicists checking a piece of obviously electronic apparatus.

The pictured equipment is installed in the Argonne Laboratory, University of Chicago, where two nuclear chain piles are now in operation. The electronic end of apparatus used in selecting, counting and studying neutrons, it is still in the "restricted" class. No detailed description of it can as yet be printed.

The physicist is Dr. Enrico Fermi, who has perhaps a shade better claim than half-a-dozen others to be considered the man who started the whole atomic ball rolling. He it was who first discovered that by slowing down neutrons, they could be made to penetrate the center of even the densest atom.

With an extra neutron in its nucleus, the unstable atom of uranium shook itself, gave off an electron, and became the new element Neptunium (No. 93) with an atomic weight of 239 (approximate). Other new *transuranic* elements never before known on earth were produced as the metamorphosed uranium atom tried to settle down.

Experimenting with the new transuranic elements, Drs. Lise Meitner and Otto Hahn of Berlin actually succeeded in splitting atoms. Fortunately for the future of the world, they did not fully understand at once what they had done. Meanwhile the Nazi secret police had discovered Dr. Meitner's Jewish ancestry, and she found it wise to leave the country. Spending some of her new leisure time in calculation (some say on the train which took her to Copenhagen) Dr. Meitner realized that the results

she and Dr. Hahn had achieved could be due only to actual atomic fission.

Meanwhile, Fermi had also been repelled from the totalitarian field, and was in New York when Dr. Meitner and



Dr. Enrico Fermi, leader in atomic research.

O. R. Frisch announced from Copenhagen that the atom had been divided experimentally. The news came in a letter from Frisch to Professor Bohr, head of Copenhagen's Institute of Theoretical Physics, who was also a visitor to New York at the time.

Drs. Fermi and Bohr determined to check the results themselves, and arrangements were made to repeat them at Columbia. There, on the 25th of January, 1939, Professor Fermi had the satisfaction of seeing his slow neutrons

break up atoms of uranium, releasing in the process the hundreds of millions of volts of energy that were later to supply power for the atomic bomb.

Fermi almost immediately discussed the possibilities of atomic power with the U.S. Navy. Armed with the new evidence of atomic fission, the scientists were able to interest the government. From that time little was heard of Professor Fermi until after the war. His important work on the atomic bomb was recognized by the United States by an award of the Medal of Merit on March 20th, 1946. The citation to Dr. Fermi reads:

"As the pioneer who was the first man in all the world to achieve nuclear chain reaction, and as Associate Director of the Los Alamos Laboratory, Manhattan Engineering District, Army Service Forces, his essential experimental work and consulting service involved great responsibility and scientific distinction. A great experimental physicist, Dr. Fermi's sound scientific judgment, his initiative and resourcefulness and unswerving devotion to duty have contributed vitally to the success of the Atomic bomb project."

Atomic research apparatus

No less important than the personalities involved in the discovery of atomic fission are the electronic devices which made that discovery possible. The neutron itself is produced by bombarding atoms with heavy particles of hydrogen. The *cyclotron* in which this bombardment takes place is thus one of the most powerful of all atomic fission research weapons.

In its simplest terms, a cyclotron is a very large vacuum tube with a pair of hollow dee-shaped electrodes connected to a circuit oscillating at a high radio frequency. Heavy positively-charged ions of hydrogen (deuterons) are introduced into the tube from outside, and are attracted first by one of the electrodes, then the other, as the oscillating field changes in polarity. The whole tube is situated between the poles of an enormously strong magnet, whose field is in such a direction as to push the deuterons at right angles to their course. The result is that they travel in circles of increasing diameter. Each time they leave one dee and enter the other, they are speeded up by the attraction of the voltage ahead of them, caused by the r.f. field which changes polarity in step with the progress of the particle. Before the end of their course they have become veritable atomic bullets, or better, super-speed battering rams, ready to knock elec-

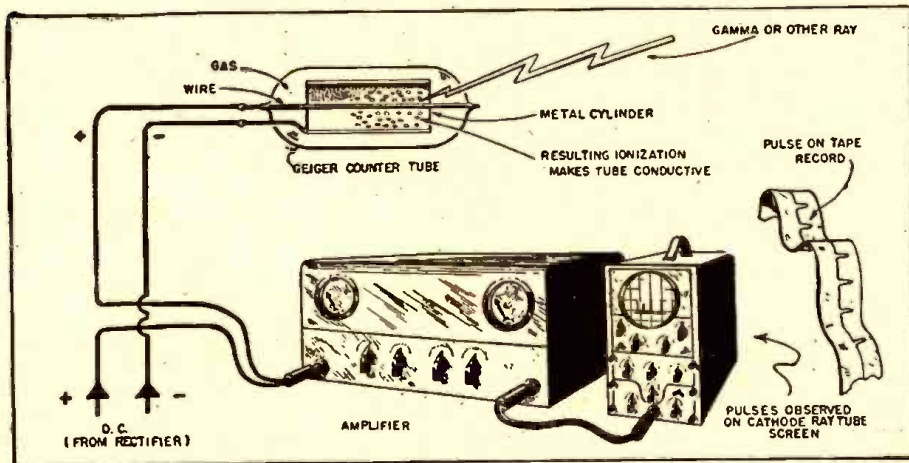

Simplified representation of a Geiger counter using cathode-ray oscilloscope as indicator.

trons, protons or neutrons out of the atoms they strike at the end of their path.

Another special type of electron tube much used in nucleonic search is the cathode-ray oscilloscope. The first news of atomic fission was flashed on a cathode-ray tube screen, in the form of voltage indications so high that no known force could have produced them. The scientist (Frisch) looking at the screen knew he could be seeing only one thing—the energy liberated by atomic fission.

The Geiger-Muller counter

If the cyclotron is a greatly-modified vacuum tube, the Geiger-Müller tube is a very ordinary one. It has been publicized to such an extent as to be possibly the best-known piece of atomic research equipment. Well known as a safety device to check radioactivity in factories which produce atomic fission materials, the terrain surrounding atomic bomb explosions, and similar areas, it is more important as a research instrument, and its invention was one of the notable steps in the advance of nucleonic science.

In its most common form, the tube is a small metal cylinder with a centrally-located wire, filled with various gases and pumped to a low vacuum. A high voltage is set up between the elements, with the central wire usually acting as the anode. Now any stray electron or negative ion will be attracted toward the filament-like anode, as in any other vacuum tube, and will appear as a current in the external circuits.

The voltage is held below the critical point at which the gases in the tube would ionize and produce a cold-cathode current (as in neon tubes and such rectifiers as the 0Z4 or the old Raytheon BH). A particle from outside (electron, proton or neutron) plowing through the gaseous atmosphere of the tube, leaves a trail of ionized particles behind it.

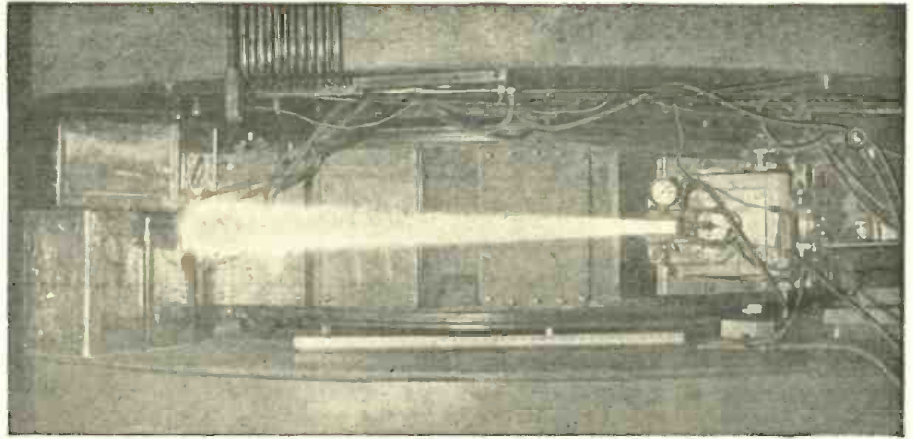

Beam of deuterons emerging from the U. of C.'s Crocker Radiation Laboratory cyclotron.

Free electrons immediately move toward the central filament, knocking more electrons from the atoms they encounter on their way. The ions thus created drift toward the outer shell, and the electrons reach the central wire and create a brief pulse of current in the external circuit. The positive ions either reach the outer shell or recombine with electrons from other atoms, and the gas is again free from ions, ready for another "count."

By properly designing and adjusting the counter and its associated circuits, it may be made particularly responsive to certain types of particles. Thus one tube may have a heavy metal shell which stops anything but cosmic rays. Another may have a thin window to facilitate entry of weak, short-range emissions. Some Geiger tubes have even been made to operate in open space at atmospheric pressure, with no envelope. A steady stream of helium gas from a pressure tank directed between the two plates provides the type of gaseous atmosphere required.

By selecting the type of envelope, the gas content of the tube and the operat-

ing voltages, the counter may be made to register one type of particle and ignore others.

One of the most important types of Geiger tubes counts slow neutrons. The tube is filled with boron trifluoride gas and the voltage is adjusted within certain rather critical limits. The pulse produced by a slow neutron is then much stronger than that produced by any other type of particle, due to the reaction with the atoms of boron trifluoride. The counting circuit may be adjusted to select pulses caused by those slow neutrons and ignore the other particles. It is hardly necessary to comment on the value of such an instrument, in view of the crucial importance of the slow neutron in atomic research.

Standard vacuum tubes

The Geiger-Müller tube was invented before amplifiers came into general use. Its usefulness on its present level dates from the day its output was fed to vacuum tubes for amplification. With sensitive amplifiers, the tube may be made to record on a tape or otherwise
(Continued on page 53)

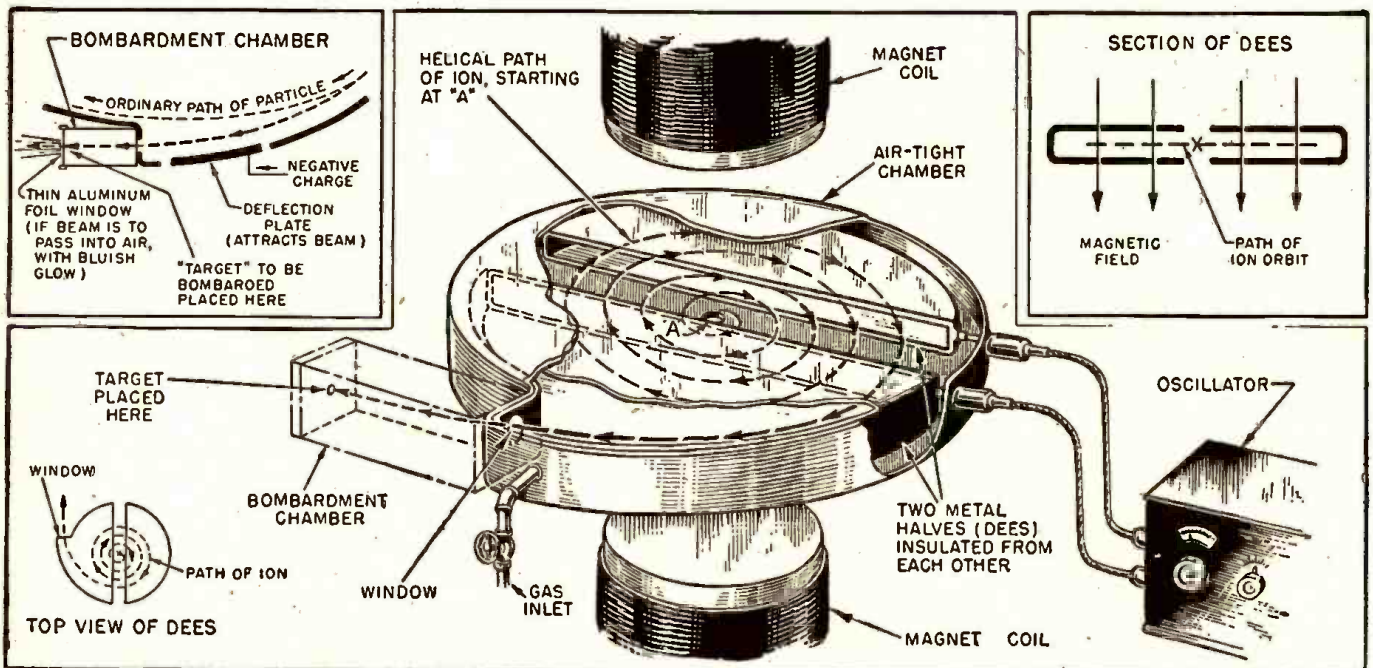

How the cyclotron works. Size of the magnets has been kept down to show dees path of the electron. See photo above for their true size.

NEW SUBMINIATURE PRINTED CIRCUITS

Printing of electronic circuits is one of the important new techniques to evolve from research and development during the war. The practicability of the printing technique was first demonstrated in a program carried on by the National Bureau of Standards leading to the development of a tiny generator-powered radio proximity fuse. A paper written by Dr. Cleo Brunetti and W. J. Cronin, of the Bureau, describes construction methods and shows circuits of a number of very small transmitters and receivers made by the printing method. This article is largely an abstract of that paper. Since the war the art has advanced to the point where complete circuits may now be printed not only on flat surfaces but on cylinders surrounding a radio tube or on the tube envelope itself.

Several types of miniature microphones, speakers, and batteries are available as suitable components to complete the operating units. The units also operate satisfactorily with standard size microphones or speakers. The transmitter and receiver of Photo A were set up for demonstration before a large

audience at the National Convention of the Institute of Radio Engineers in New York City, March 5, 1947. The transmitter is plugged into a comparatively heavy-duty power pack, while the standard size carbon microphone with matching transformer is plugged into the other end. The 2 x 3-inch receiver mounted on the 10-inch console speaker had sufficient power to operate the speaker so that it could be heard clearly throughout the crowded auditorium.

Logical auxiliary components for a portable unit would be a set of small hearing-aid batteries and a miniature crystal speaker or hearing-aid type of earphone. If the combination is to be used as a personal telephone, the transmitter and receiver may be combined to operate with the same set of miniature batteries. In this way a very compact portable unit is possible, which, including batteries, microphone, and speaker, may be easily

slipped into a package the size of a man's ordinary wallet. Since arrangements can be made to insert batteries in flashlight manner, reserve battery capacity is usually unnecessary.

Jobs for subminiature sets

For many uses, such as when taking inventory in department stores and speaking in public, two-way conversation is unnecessary. In such cases the portable unit consists only of a transmitter made up of a tiny battery pack, a subminiature tube with circuit painted on its envelope, and a tiny crystal microphone. The microphone conceivably could be clipped to a man's tie with a pair of light wires leading to the remainder of the unit, which may be housed in a package slightly larger than a penny matchbox and carried in the user's shirt pocket. The transmitted voice may be picked up on a standard receiver in an adjoining room and fed to a recording unit, to loudspeakers of an auditorium, or to any desired reproducing system.

In other cases, where distance of transmission is small or where conversation between a variable point and a fixed high-power transceiver is desired,

Photo A, below—Ten-inch console speaker operated by tiny 3-tube receiver, with signals from lipstick transmitter, shown plugged into its power pack. Photo B, right, top—A series of lipstick transmitters; below—Development of a printed-circuit steatite-plate transmitter.

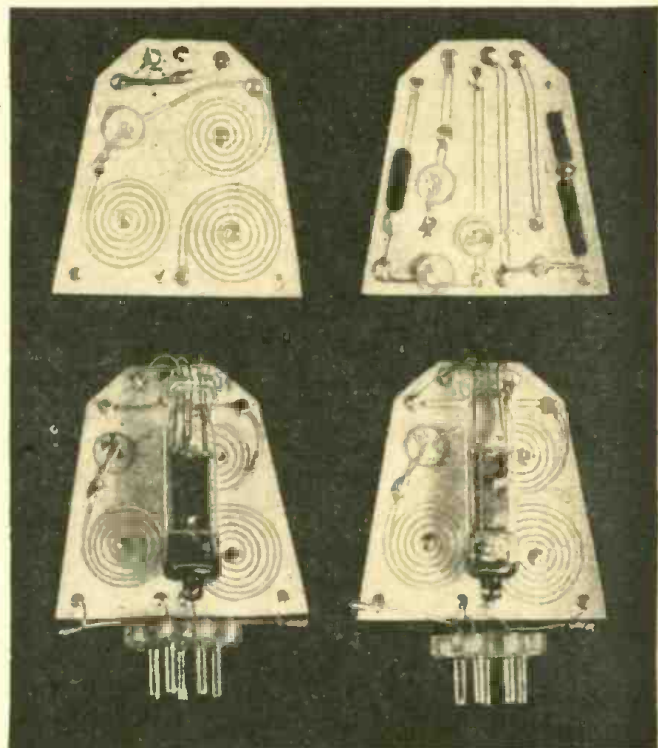
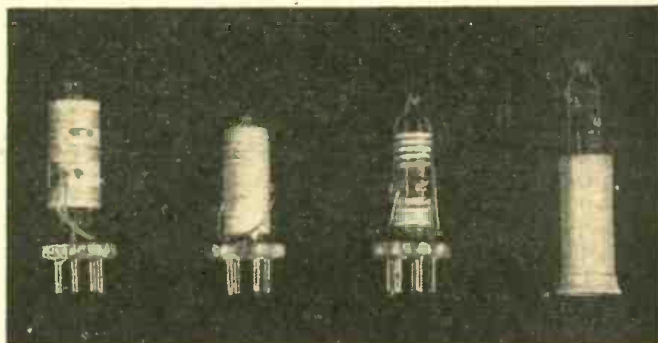
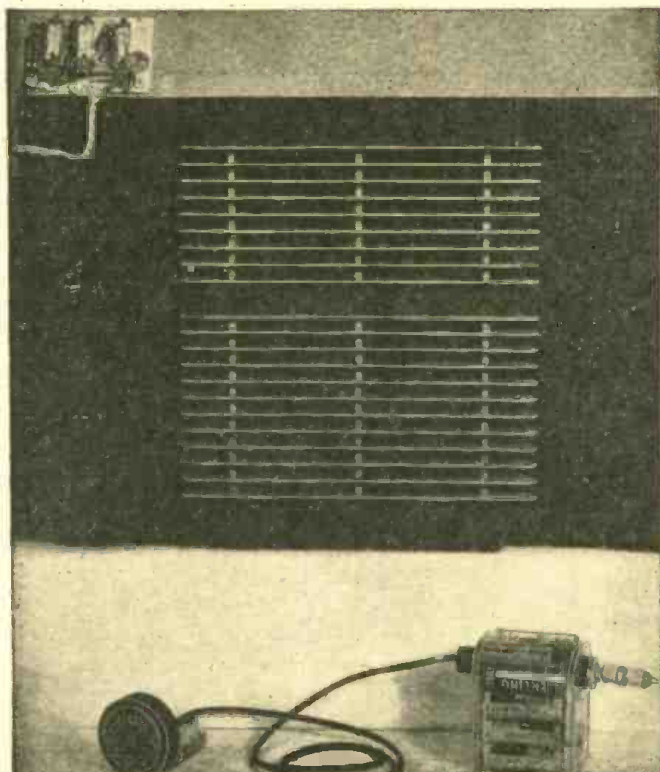

the complete portable unit could be extremely compact. An example is the case in which a field crew maintains contact with a base station or with mobile units, such as trucks or aircraft carrying moderate-powered transceivers. In another application, such portable units would dispense with the usual flagging methods of lining up commercial aircraft after landing or in assisting planes taking off or landing on aircraft carriers.

Personal radiotelephones could be valuable in many applications—for example, in factory and store, on farms, and by surveyors, hunters, and explorers. In addition there are numerous applications in crime detection and traffic regulation, in limited ship-to-shore communication, and in emergencies such as forced landings or isolating floods.

A simple 2-tube unit consisting of an oscillator and amplifier stage may suffice for these applications. One such unit constructed at the Bureau employs a microphone operating into an amplifier which modulates an oscillator coupled to an antenna. Pressing a button converts the unit to superregenerative reception. For receiving, a magnetic earphone may be operated from the amplifier stage.

Lipstick transmitters

Figs. 1 and 2 are the circuits of the first four transmitters of Photo B. They operate in one of the Government bands—132 to 144 mc—and were used in public demonstrations at Columbus, Ohio, and New York. On at least two instances, these subminiature transmitters "went on the air" over national networks with excellent results.

The sets of Fig. 1 are made in two types. The circuit is painted on the tube envelope in Type I, and on a steatite cylinder surrounding the tube in Type II. Sylvania or Raytheon miniature triodes are used for both types. In both transmitters, B is 120 volts, and C is a 7.5 μ mf

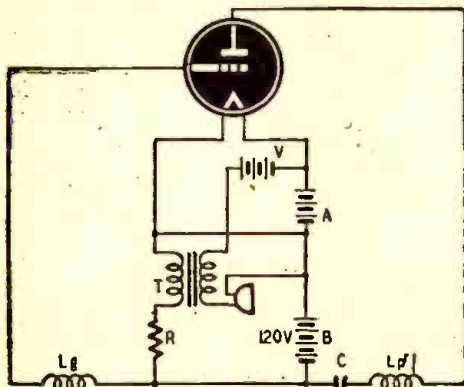

Fig. 1—Circuit of the lipstick transmitter.

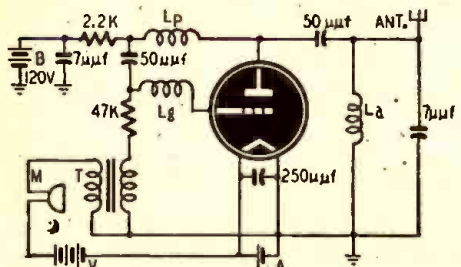

Fig. 2—Schematic of flat-plate transmitter.

high dielectric ceramic capacitor, $\frac{1}{8}$ inch in diameter by 0.030-inch thick. It is attached directly to the tube in Type I. M is a carbon microphone and T is a miniature microphone transformer. R is 50,000 ohms in each transmitter. Plate current in both sets is 3 ma and filament current is 0.2 ampere.

Type I uses a Sylvania 6K4 triode, with 6 volts on the filament. Microphone battery V is omitted, since the 6-volt filament battery is sufficient. Lg is 4 turns and Lp 5 turns, of silver paint on the tube, as can be seen in Photo B. The 50,000-ohm resistor is also painted on the tube, with graphite paint.

A battery-type Raytheon subminiature triode is used in the transmitter of Type II, which has its circuits painted on a steatite cylinder slipped over the tube. Battery voltage A is 1.5, and an additional battery V of 4.5 volts is added for the microphone. Lg is 3 turns and Lp 6 turns painted on the cylinder, at approximately 16 turns per inch. The cylinder is 1 inch long, $\frac{1}{2}$ -inch outside diameter, and $\frac{1}{32}$ -inch thick.

The Type III transmitter (Fig. 2) is large by comparison, being printed on a flat steatite plate $1\frac{1}{2}$ inches high by the same width at the bottom. It is shown in the lower section of Photo B. The battery-type triode with 1.5 volts on the filament is used in this set, and the coils are spiral-wound (painted) on the plate. (Old-timers who saw the helix go out forever in the '20s will reflect that there is indeed nothing new under the sun!) Lg and Lp are $4\frac{3}{4}$ turns each, "wound" to 7-16-inch outside diameter, and La is $5\frac{1}{2}$ turns, $\frac{5}{8}$ -inch outside diameter. Frequency of the transmitter is 140 mc and that of tubular transmitters is 136 mc.

The lower part of Photo B shows the development of the flat-plate transmitter (both sides). The upper side carries the three spiral coils and a 50- μ mf coupling capacitor. The lower side bears the remainder of the circuit wiring, including three resistors (the dark rectangles) and four capacitors. One of the resistors, though not shown in the circuit diagram, is connected to the grid coil. It serves as a blocking resistor for measuring the oscillator grid voltage.

The receivers in Photo C are wired with the circuit in Fig. 3. Two of the units shown in the photo are on steatite plates 2 x 3 inches (bottom) and 2 x 5 inches (center), respectively, while the third is on a 2 x 5-inch lucite plate. They employ a square-law detector stage followed by two stages of pentode amplification and a triode output stage feeding the loudspeaker. The input tuning is broad to allow reception over the complete band of 132 to 144 mc. If sharper tuning and additional sensitivity is desired, the input stage may be converted to one employing superregenerative detection.

Painting the circuits

Several types of paints were used, most of them obtainable commercially. A satisfactory silver preparation is a sodium-silicate paint known as Saucereisen Conductuluté. Another suitable sil-

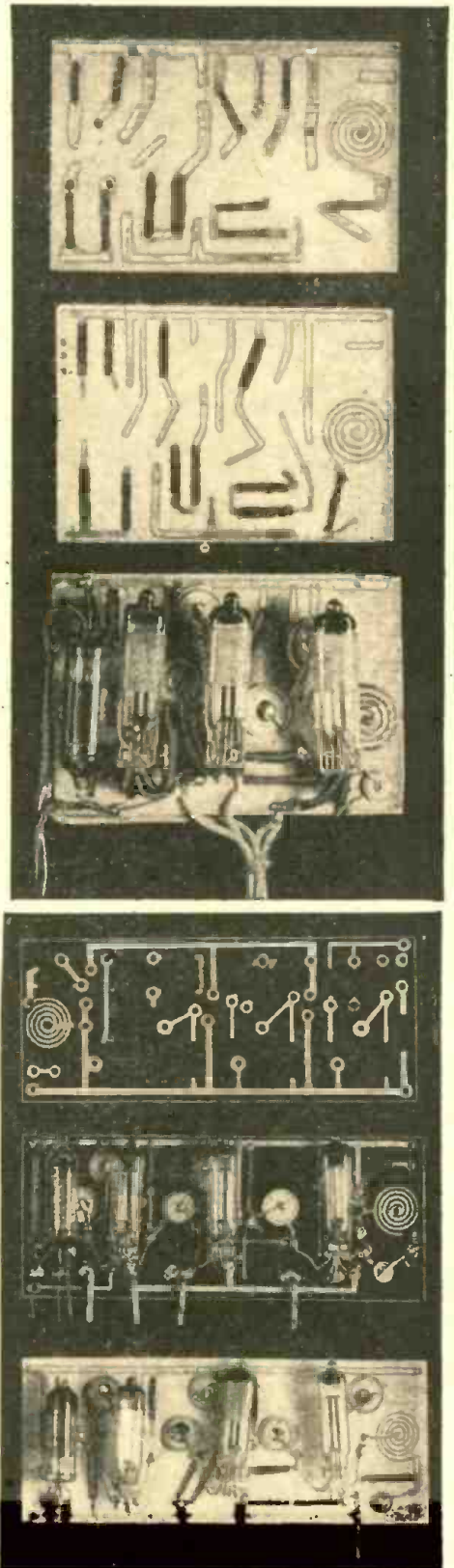

Photo C—Front and rear of three flat receivers, printed on steatite, and lucite bases.

ver paint consists of powdered silver in lacquer solution, the consistency being adjusted with an acetate solvent. About 65 per cent of silver powder is used. Silver plating is found to increase the conductivity of the painted coils.

A resistor paint which dries at room temperature may be made of 27.5 percent graphite powder, 34.5 percent methyl-methacrylate lacquer, 29 percent toluene and 9 percent lampblack. More

(Continued on page 65)

★ ★ ★ ★ ★ ★ ★ ★ ★ ★ ★ ★ ★ ★ ★ ★ ★ ★

"Shooting Stars" Tracked By Radio

By S. R. WINTERS ★ ★ ★ ★ ★ ★ ★ ★ ★ ★ ★ ★

NOT being content with having transmitted signals to the moon, radar researchers are now contacting shooting stars as they plummet to earth! Or, more accurately stated, the National Bureau of Standards is employing radar as a means of studying ionization produced by show-ers of meteors as they shoot through space.

On scopes or screens of radar equipment at the Bureau of Standards' station at Sterling, Virginia, echoes from the meteor shower identified with the Giacobini-Zinner comet were plainly visible during a 5-night period between October 7 and 12, 1946. The signals were intercepted by a standard Signal Corps SCR-270-D radar outfit, functioning at 107 megacycles and sending 25-micro-second pulses at a rate of 400 per second. The maximum power employed was 100,000 watts. The radar antenna, composed of 32 dipoles arranged in a rectangular fashion, was adjusted at an azimuth of 315 degrees and at a height of 45 degrees. The width of the main beam of the antenna was about 40 to 20 degrees between half-power power points. The major axis was vertical.

Radar signals were viewed on both the A and PPI oscilloscopes. A photographic impression was kept of the PPI manifestations. The A scope or screen was

S. R. Winters, who claims to be "the oldest professional writer on radio subjects" in the United States, was born on a farm in Granville County, N. C.

Starting life as bookkeeper and freight handler, he learned the Morse Code and became station master in a small station. Later he worked his way through the University of



North Carolina as printer, also by writing sketches on scientific and biographical subjects connected with the University, thus beginning his career as scientific writer.

Began writing on radio telegraphy before broadcasting started, publishing articles in *Wireless Age* and later in *Radio News*. Since then has contributed to practically all the radio and scientific publications in the United States, his articles having been published in more than a hundred magazines and papers.

operated by an experienced technician, who maintained a record of the time, range and duration of the pulses. The shower of meteors, according to a forecast by astronomers, was expected to attain its peak on the night

of October 9. Actually, the rate of the shooting stars climbed from about 8 per hour between 7:30 pm and 8:30 pm to a maximum of more than 1 per minute



Bright traces on screen are meteor tracks.

between 10:30 and 11 pm. The recorded facts coincided with the anticipated period of 10 o'clock for the greatest intensity of the Draconid comet shower. Following this peak, the rate of occurrence dropped to about 20 meteors an hour after 11:15 pm. The distance range was from 60 to 209 miles. The transient radar reflections lasted generally about 1 second or less, although an appreciable number had a duration of several seconds. The Bureau of Standards reports that only a few of the signals seemed to change distance during the period that they could be seen on the screen, and this slight shift was only 5 miles or less.

Simultaneous but independent observations were made by the Signal Corps in New Jersey, employing radar sets at a frequency range of 600 to 1,000 megacycles. Results were apparently negative. But according to an appraisal of the Bureau of Standards, in final analysis these negative findings were significant in that they suggested "that the ionization density reached in these meteors is such that the upper limiting frequency which they could reflect is between 100 and 600 megacycles."

Detecting meteors by radar is not merely a spectacular "show". This radar investigation of meteors is being made because of the probability that meteors

(Continued on page 72)



Receiver console and antenna of the SCR-270-D radar used by the Bureau of Standards to track meteors. The hooded equipment is the camera.

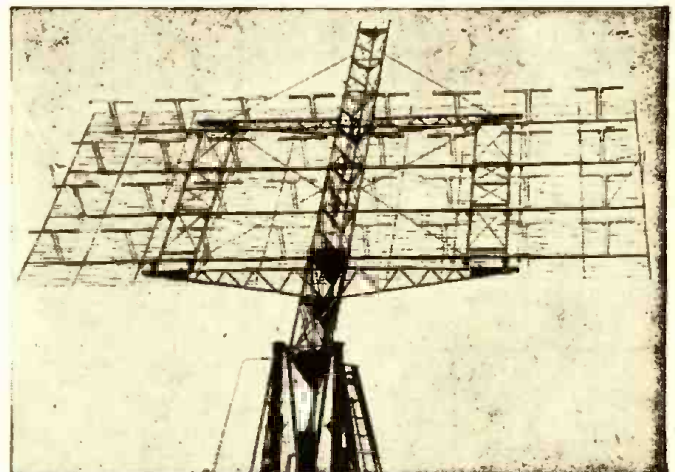

ANTENNA PRINCIPLES

PART VII--Parabolic reflectors as antennas

By JORDAN McQUAY



U. S. Army Signal Corps Photo
Photo A—An antenna for 10-centimeter waves.

DIRECTIONAL antennas operating in the true microwave region—at frequencies higher than 1,000 megacycles—take on physical and electrical aspects entirely different from those operating at lower frequencies.

Radio waves only a few centimeters in length have many of the characteristics of infra-red light waves. They are reflected by almost any surface or object with little or no loss of power. The waves may be refracted by differences in air layers between transmission points, or by reflected impedances along a transmission path. Many of the principles of optics—particularly laws governing the operation of lenses—are applicable to microwaves. After being focused into a narrow beam of energy, microwaves can be propagated from point to point like a narrow beam of light. Microwave antenna systems make use of all these quasi-optical properties of centimeter waves. Microwave propagation—from point to point—is always along *direct* or semi-optical paths. There is no ground wave. And the sky wave is of no practical use in propagation.

The usual laws of antenna reciprocity apply to u.h.f. technique: a good radiator or transmitting antenna is a good receiving antenna. Both function more than 30 or 40 wavelengths above ground. Thus, microwave antenna systems can be considered as operating in free space, without ground effects.

Polarization is important only in that both transmitting and receiving systems must be identically polarized. In practice, horizontally polarized microwaves are more generally used.

Directional antenna arrays* are inadequate for operation at wavelengths less than about 30 centimeters (frequencies greater than about 1,000 megacycles)—because of the close proximity of elements of the array and gen-

eral structural difficulties. At shorter wavelengths (or at higher frequencies), entirely new systems of microwave transmission are necessary.

Progressing downward, in terms of wavelengths, there are three principal types of such systems.

Parabolic reflectors are the most widely used means of transmitting and receiving microwaves in the region between about 30 centimeters and about 3 centimeters.

Electromagnetic horns function in the region between about 20 centimeters and 1 centimeter. Theoretical rather than practical, use of such horns is largely confined to the experimental laboratory. However, some are used to feed parabolic reflectors.

Metal lens systems—newcomers to the microwave field—are practical for operation in the region between 10 centimeters and less than 1 centimeter, providing extremely narrow beams of microwave energy.

Parabolic reflectors

A highly directional beam—for radiating and receiving quasi-optical microwaves—follows the laws of optical reflection.

Light waves are so reflected from a smooth mirror surface that the angle made between the reflected wave and the surface is equal to the angle made between the incident wave and the surface.

A concentrated beam of parallel light waves is formed when a point source of light is surrounded by a mirror-surface of such shape that—due to the above law of light reflection—parallel waves are produced in a very intense and directional beam.

A reflecting surface satisfying this requirement is a rotational parabola (Photo A), a type of mirror having an *axis* and a *focal point*. The focal point is located along the center axis of the parabola.

When a source of light is situated at the focal point, all light waves incident on any part of the parabola will be reflected in such a way that they travel outward, parallel to the axis of the parabola (Fig. 1.) The source of light waves must be small to obtain a well-focused beam.

To concentrate *all* radiated light into the parabolic reflector, a very small hemispheric reflector is used (Fig. 1) to prevent outward radiation from the point source of light and thus limit the beam to the desired parallel waves.

The analogy with microwaves is identical. They can be reflected and focused exactly as in Fig. 1, using a rotational parabola as a reflector behind a source of u.h.f. radiation. When the source is situated at the focal point of the parabola, a narrow beam of microwave energy can be directed toward a similar receiving parabolic device.

The reflector should be at least 10 wavelengths from edge to edge.

The antenna in Photo A operates at a wavelength of about 10 centimeters, and is used for the transmission and reception of radar pulses. The complete equipment is used by the U. S. Army for tracking down aircraft, and a considerable part of its accuracy depends upon proper functioning of the antenna

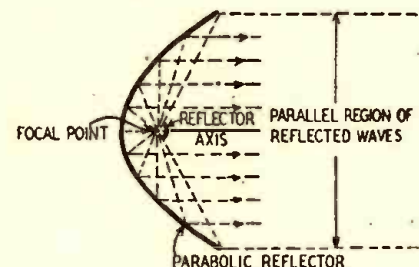
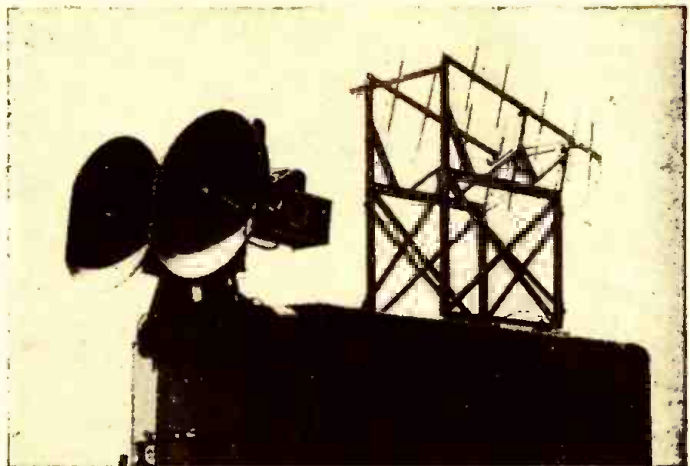

Fig. 1—How waves are reflected by parabola.

system. A dipole radiator is contained in a small weatherproof enclosure at the focal point of the parabola. And the entire antenna system can be rotated and moved in elevation to provide high power gain in any direction.

(Continued on following page)



British Official Photo
Photo B—Twin reflectors used in 9-centimeter anti-aircraft radar.

*Discussed in the April and May issues of RADIO-CRAFT.

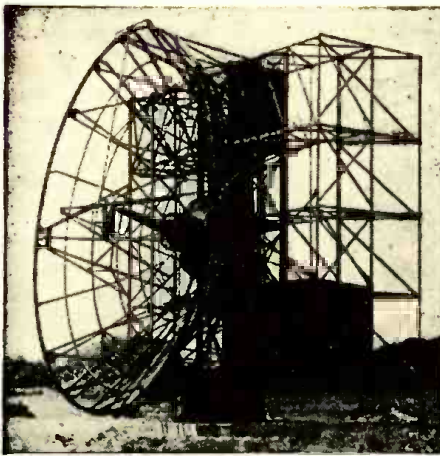

British Official Photo

Photo C—A 35-foot parabola for 50-cm waves.

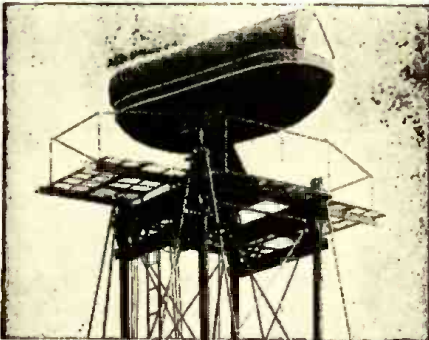

U. S. Army Signal Corps Photo

Photo D—A modified-parabola radar antenna.

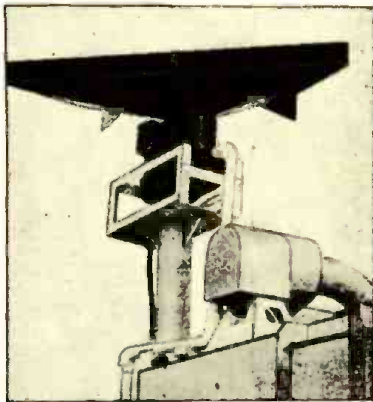

British Information Service

Photo E—Radar antenna on Queen Elizabeth.

A pair of dipole-fed parabolic reflectors (Photo B) are used in British anti-aircraft microwave radar equipment, operating at a wavelength of less than 8 centimeters. One transmits u.h.f. pulses, the other is used for receiving.

Parabolic reflectors are restricted normally to wavelengths of less than about 10 centimeters. However, a number of systems were developed during the war which operate as high as 40 or 50 centimeters, with corresponding increase in the physical size of the structure and components. One such arrangement (Photo C) is the antenna system used with fighter-director radar and ground-control equipment by the Royal Air Force. The antenna is a dipole-fed parabolic reflector 35 feet in diameter. An almost-invisible screen is used as the reflecting surface of the parabola. Remainder of the antenna consists of

structural supports and rotational gear for moving the antenna in azimuth.

The inner or reflecting surface of any parabolic reflector must be metallic—preferably copper or other highly conductive metal. Small parabolic reflectors may be constructed of any solid weather-resisting substance, provided the inner reflecting surface is smooth and coated with copper or other conductive metal. However, the presence of holes or perforations in the reflector does not alter its effectiveness, if such apertures are no greater than $\frac{1}{2}$ wavelength in diameter. Thus extremely large parabolic reflectors (as in Photo C) can use any sort of wire mesh or screen meeting these aperture requirements.

Perforations, holes, or openings—when no greater than $\frac{1}{2}$ wavelength—do not detract from the operation of the parabolic reflector. They serve principally to minimize wind resistance for certain outdoor installations, or when sheet metal may not be available or desirable.

Other parabola types

A reflector consisting of a rotational parabola (A in Fig. 2) is circular in shape when viewed along its axis, and concentrates energy almost equally in all planes. Thus the horizontal and vertical radiation patterns are practically similar in shape—providing almost equal directivity in both horizontal and vertical fields.

To concentrate a high percentage of the u.h.f. energy in either the horizontal or vertical field, a cylindrical parabola (B in Fig. 2) is used—having a focal line instead of a focal point. A cross section of this type of reflector appears as a parabola in only one dimension—and that dimension is the plane of greatest directivity of the u.h.f. beam. Often the open ends of the cylindrical parabola are closed to provide slightly greater power gain.

Other variations (C and D in Fig. 2) consist of narrow sections of rotational parabolas, having closed ends or closed sides. These are known as *sectional parabolas* (sometimes called *cheese-boxes!*) and are found in an extreme variety of sizes.

They provide extreme directivity in particular planes of the radiation pattern. In general, the beam width is inversely proportional to the width of the sectional parabola. And the resulting radiation beam is sometimes known as a "fan" beam.

Often parasitic elements are added to one of these parabolas to further improve or in some way influence the pattern of radiation according to some particular microwave requirement. Such an antenna (Photo D) provides a beam of extreme directivity for radar searching purposes, but the beam in the vertical plane is affected by the parasitic (lower cylindrical) element so that none of the energy is dissipated downward.

Sectional parabolic reflectors are generally fed by an open-ended wave guide or by an electromagnetic horn terminating a wave-guide system. Either method provides a "spray" of u.h.f. energy

against reflecting portions of the parabolic surface. The resulting directional (output) pattern, however, is determined largely by the physical shape and dimensions of the reflector itself.

A very narrow sectional parabola is used on the flying bridge of the British liner *Queen Elizabeth* (Photo E), providing a short-range but high-definition searching beam for the ship's radar equipment. The parabolic reflector functions on about 7 centimeters, and is fed by a conventional wave-guide system. The radiation pattern is narrow in the horizontal plane, much wider in the vertical plane, making the antenna system useful for precision sea-search radar. A long-wave long-range radar for detecting and locating aircraft uses a parabolic antenna, and completes the radar installation on the *Queen Elizabeth*.

An "open" sectional parabolic reflector (photo F) is used with Western Electric radar designed for American



Photo by Western Electric

Photo F—Radar antenna for merchant marine ships, now in service on inland waterways. This is just another of the endless variety of shapes and sizes of parabolic reflectors.

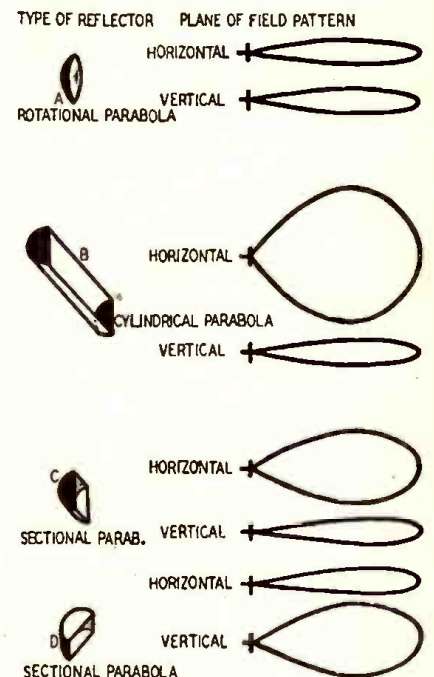

Fig. 2—Special parabolas and their patterns.

NOISE ELIMINATION

By JACK KING

NOISE in many receivers, particularly in large cities, presents one of the serviceman's hardest jobs, in getting the noise out of the radio, or in reducing it to so much lower level that the customer can notice a decided improvement.

If the noise is in the receiver the job may not be very difficult, but if it is due to external causes getting rid of it is likely to be a difficult matter.

One of the best ways of attacking the problem is to listen to the noise. Make an effort to identify the noise generator by its characteristic sound. Vacuum cleaners produce a sort of whining or whirring noise, electric razors produce a series of loud sputterings much like an old-time spark transmitter, and neon signs and various other types of devices produce sounds which, with experience, can be identified. For example, the noise of a d.c. motor is easily recognized once it has been identified and associated.

A small portable receiver, battery-powered and equipped with a loop antenna, may be used to run down the noise. When the loop is in the same plane as a line drawn toward the noise source,

noise pickup will be strong, and when the loop plane is at right angles to the source, minimum noise will be heard. When the approximate direction of the noise source is known, the field is narrowed down considerably and time is saved.

In some cases, a little adroit questioning may lead directly to the cause. If the customer states that it is heard only at definite times of the day or night, the time is a clue. If the noise is heard only when a telephone is dialed or a refrigerator swings into action, the sources are perfectly obvious. If trouble appears only when the drugstore downstairs is open and its neon sign is lighted, it requires no great stretch of the imagination to decide that the neon sign is causing the trouble. This can be checked with the druggist's cooperation.

It is good practice to take the portable receiver with you to check the sign. If the noise dies out on it when the sign is shut off, it is probably defective and should be gone over by a sign man.

Usually the owner of the sign will listen to reason and will be glad to do anything practical if not too expensive to get rid of the interference. In some cases this may involve merely having the sign company put the sign in proper working order. In others it may call for

the application of a heavy-duty filter to the sign to cut down the noise.

The basic circuit of a simple filter is shown in Fig. 1. In some cases the high-voltage transformer may develop leakage and the leakage current may result

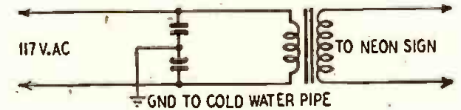
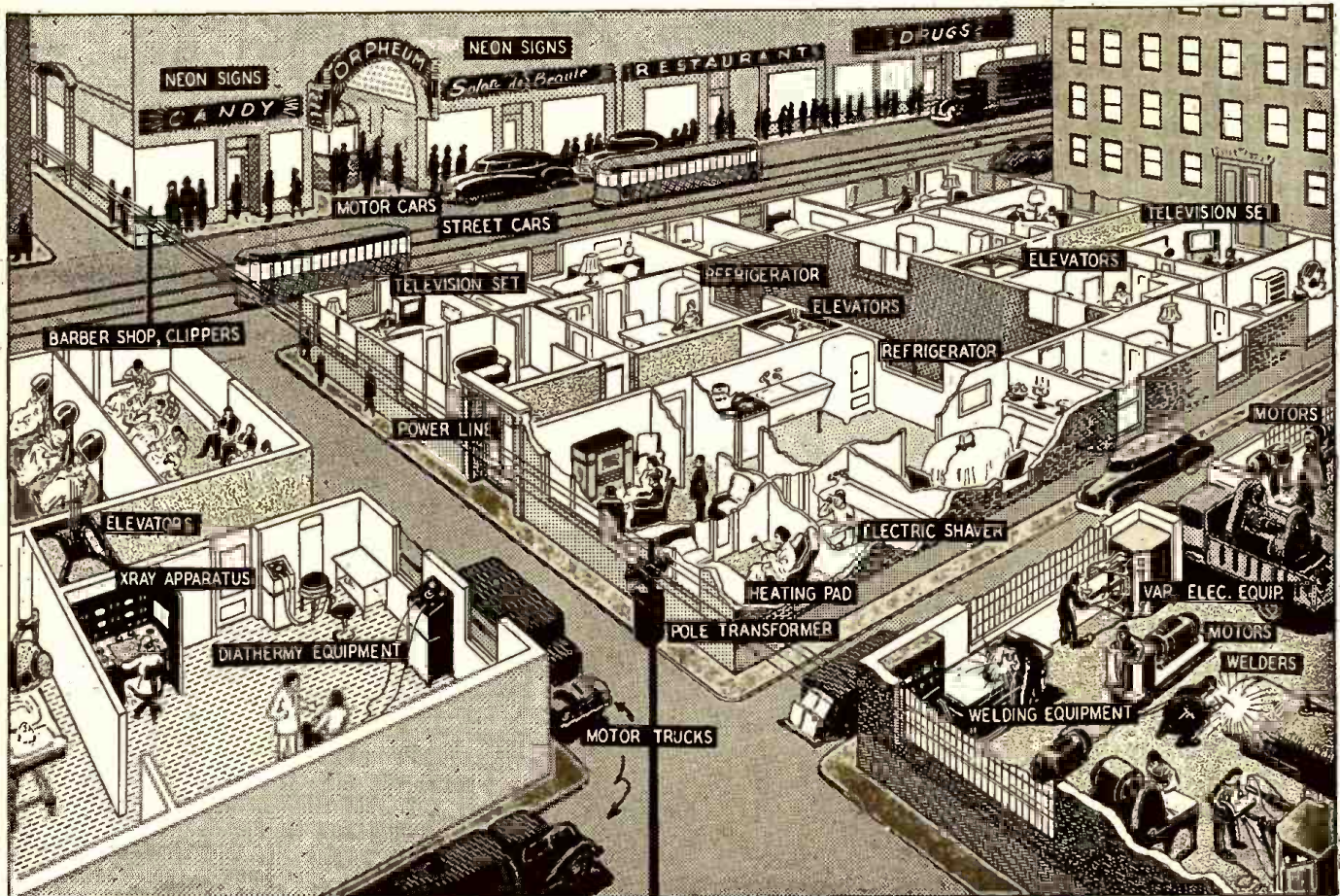

Fig. 1—Simple filter. Try 600-volt condensers from .01 to 2 μ f, smaller sizes first.

in excitation of the distributed L and C to produce damped oscillations. Replacement of the transformer will get rid of the noise without a filter in such cases. If the filter is used, the radioman will often find it more practical to get an electrician to install it with BX cable and a box rather than attempt to handle the heavy wiring himself. Of course, if you have an electrician's license you can do it yourself.

Sometimes a human problem is involved. The whole neighborhood may be bothered by the noise, but no one wants to pay to get rid of it. If a number of people chip in and present the owner of the sign with the filter, he will usually cooperate by letting it be installed—
(Continued on page 62)



Just a few of the many types of interference with which the serviceman must contend. Even television sets often interfere with each other.

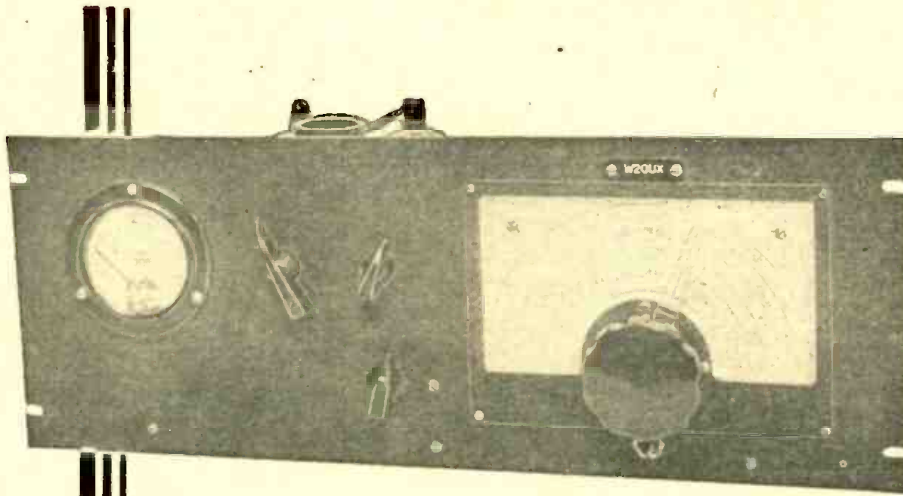

V.F.O. EXCITER OR TRANSMITTER

Part I—Variable-Frequency Oscillators

By I. QUEEN, W2OUX

BEFORE the introduction of quartz crystals, all transmitters were controlled by variable-frequency oscillators. The advantages of the crystal oscillator over the old Hartley or tuned-plate, tuned-grid circuit were so great that the crystal reigned supreme for a number of years.

With the increase of QRM which has come with the great upsurge in the number of operators on our narrow bands, even a transmitter with several crystals cannot guarantee a clear channel for a reasonable part of the time. Many hams have turned again to the variable-frequency oscillator (v.f.o.) as a solution to the problem. Of course the modern rig is incomparably more stable than the old self-excited transmitter circuit.

We have built and operated several v.f.o. transmitters here at W2OUX during the past few months. This means of frequency control has a number of definite advantages. The disadvantages are equally definite, and at first glance seem far more numerous than the advantages. Fortunately these problems can all be solved very satisfactorily, and the few advantages far outweigh all the disadvantages combined.

Variable-frequency control is at its best in a simple, low-power rig. These suffer first and worst when QRM begins to cover the band, but a highly "mobile" frequency permits change in frequency as required. Since a channel that is clear one minute may be hopeless a few minutes later, quick tuning is necessary. There is no advantage in frequent retuning if "umpty" amplifiers, doublers, or quadruplers must be resonated each time. In a multistage transmitter it may be better to incorporate 10 or more crys-

tals and switch in the one that gives the best opportunity for QSO at the time.

There is no question about the superiority of the crystal transmitter where stability is concerned. It is simple to design, especially since harmonic type crystals have become available. A single tube can give an output at 15 or 20 meters, to be further divided as desired. A v.f.o. requires 2 or 3 stages to obtain the same output as that of a crystal stage. Turning a dial to reach a desired frequency is not as easy as throwing a switch. The variable-frequency oscillator usually is designed to operate at 80 or 160 meters and this requires a whole row of doublers or quadruplers to reach the higher frequencies. Any slight instability (such as chirp or drift) is then multiplied by the order of the harmonic.

Some hams have been quick to adopt and keep v.f.o. technique, while others maintain that crystal control is far superior all around. This difference in opinion is reflected in modern amateur transmitters, both commercial and home-built. Some are designed for exclusive crystal control, others feature v.f.o. control; with crystal control as optional in other cases. A 3-stage, highly stable v.f.o. rig is now being operated at W2OUX with very satisfactory results. Reports are "T9 crystal" and the tuning is as easy as with any crystal rig we ever built. This transmitter will be described in a following issue.

Oscillator design

The basic difference between the two types of control is in frequency stability. Mechanical and electrical disturbances have little effect on a quartz element, but special precautions must be taken with self-excited oscillators. The v.f.o.

stage must be completely shielded and its tank must be high C in order to obtain a high-Q circuit. At 80 meters about 500 μf of capacitance should be available. With such a high-C tank, changes in resistance or capacitance in the following stages have little effect on frequency. Likewise, mechanical disturbances such as table vibration are negligible, because the large tank capacitor masks the effect of minor changes in capacitance.

In precrystal days, the large capacitance was made up by an enormous variable condenser, often of 1,000- μf maximum capacitance. The modern method is to use a fixed capacitance as well as a variable condenser. This is possible only when low-temperature-coefficient condensers (ceramic type) are used.

Even in a well-designed transmitter, there will be a slight reaction on the oscillator from succeeding stages. Therefore all stages should be of rugged construction with short, direct wiring.

Isolation precautions

The oscillator must be carefully isolated from other stages and from antenna radiation pickup. A strong field will block the oscillator and cause a chirpy note on continuous wave. Completely shielding the oscillator will eliminate this difficulty and will prevent direct pickup from succeeding stages.

The oscillator frequency may be as stable as that of a crystal when no loading is present. When buffers and amplifiers are added, their loading effect may vary (as during tuning). Even slight changes in antenna loading caused by swinging may be fed back through amplifier stages to cause a corresponding frequency change. It is good practice therefore to follow the v.f.o. stage with at least one class-A buffer, in which the grid never goes positive and therefore does not take any power from the oscillator.

Reaction on the oscillator may take place through grid-plate capacitance coupling in the buffer tube. Best buffer action is obtained by using tubes which have a low grid-plate capacitance. Type 802 is one of the best for this purpose, but it is expensive and is not available as a surplus item. Fortunately, the 6F6 is also excellent, its capacitance being only about half that of the beam tubes 6V6 and 6L6. Beam tube 807 is rather large for a buffer but it makes a good final or exciter for a higher-power final because it has a low capacitance.

Tone quality

Under ordinary conditions the output of a high-C oscillator with an amply filtered power supply will be T9X, but conditions are not always "ordinary." During early experiments we ran into an unusual difficulty in this respect. Monitoring showed that the output of the v.f.o. rig was "crystal" until an antenna was connected. The quality then dropped to a rough, modulated T7, although a crystal rig set up alongside and using the same power supply sound-

(Continued on page 51)

Battery Superhet Uses Three Tubes

By WILLIAM HEDRICH

THREE tubes are used to give full 4-tube results in this small portable superhet. Operating on but one small 45-volt B-battery, and two flashlight cells, this set makes an ideal vacation companion, regardless of how far you are from the power lines.

The little set was designed around the three following modern battery-type tubes, requiring a plate and screen potential of only 45 volts: 1R5 as mixer-oscillator; 1T4 as i.f. amplifier; 1D8-GT serves as 2nd detector and 1st and 2nd audio stages. The battery drain is very low, A drain being 200 milliamperes, and B drain being about 7 mils. The set makes an ideal personal portable for the beach, the summer cottage or picnic. It also makes an ideal bicycle radio, using a fishpole automobile-type aerial. In this case use the bike frame as a ground.

A piece of sheet steel or aluminum, 6 x 8 inches, serves as a chassis. The author used 20-gauge aircraft aluminum, which was very satisfactory. It is well to lay out and drill all holes before bending the sheet. Lay out the various lines on the chassis with a sharp-pointed instrument such as a

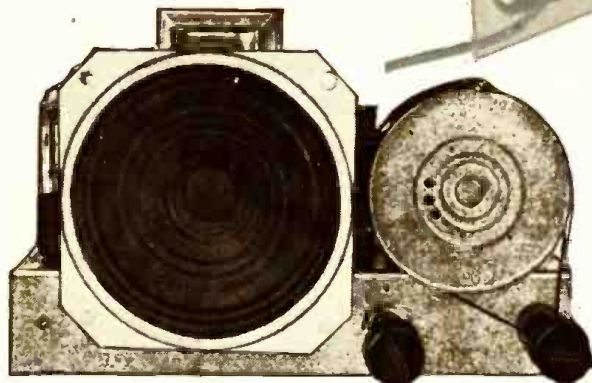

The little set, built on a base 8 x 3 inches, is well laid out. While number of tubes is low, this circuit often gives excellent results. A little regeneration may add to sensitivity greatly.

scriber. Never use an ordinary pencil for this work, as the sharp point will wear away, causing inaccuracies. Be sure and center-punch all holes before drilling. Bend sheet back 1½ inches each side, to give a finished base 8 inches long x 3 inches wide x 1½ inches high.

Mount all the parts before doing any wiring. This will save your temper if later on you find that the volume control has to be removed and the oscillator coil put in first.

Standard parts are used throughout. Any good set of antenna, oscillator, and i.f. coils will work. Those on the set were Meissner 14-1022 antenna, 14-4034 oscillator, 16-6658 input and 16-6660 output i.f. transformers. A 2-gang 365-μmf variable condenser with trimmers is used, and the padder condenser has a maximum capacity of 350 μmf.

Good soldered connections are a

"must" in a set of this small size. Use a good grade of stranded hook-up wire and keep all grid and plate leads as short and direct as possible. Be especially careful in soldering to the small miniature tube sockets used to support the 1R5 and 1T4 tubes. Use only enough solder to make a good sound connection, and do not let solder or rosin run over to adjacent terminals. Grounds are made to soldering lugs placed under screws. Stick to the layout as closely as possible, as this will permit short leads. There are no coils to wind, and either a built-in loop aerial or a midget antenna coil may be used.

Wire the set in the conventional manner—filament circuits first, then grids and plates. Although there is no trick in wiring or building this little set, it is well to take your time, unless you are familiar with wiring multitube circuits.

(Continued on page 71)

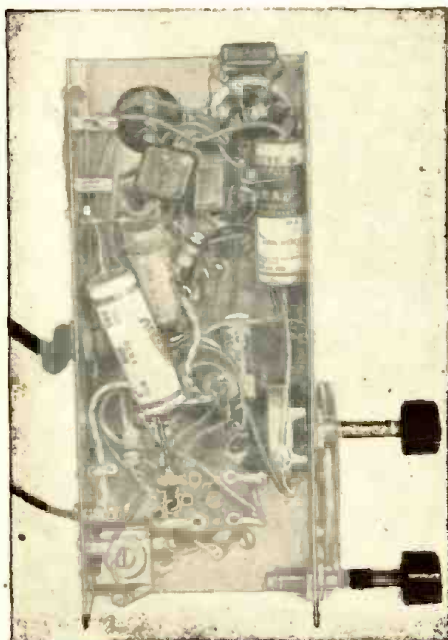

Under-chassis view of three-tube superhet.

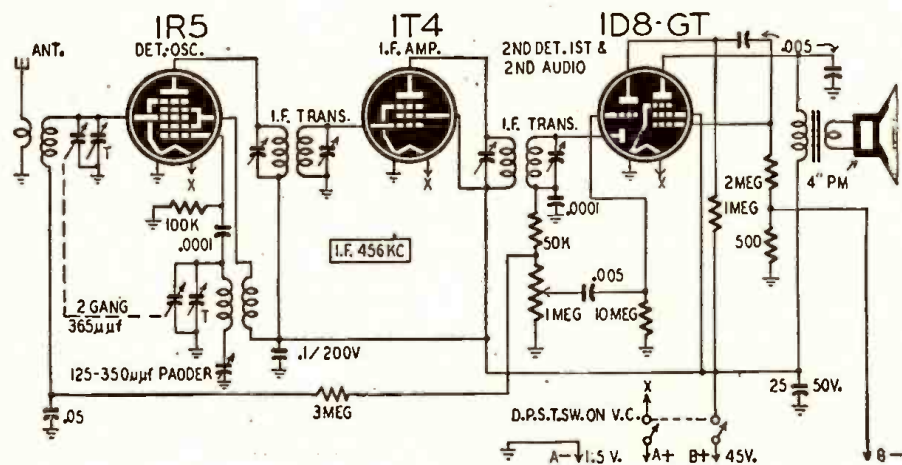

Schematic of the receiver. Fixed bias used with the 1D8 output tube improves quality.

A Small Recording Studio

PART IV—Operating the recording equipment.

Speed, needle and record cut considerations.

By J. C. HOADLEY

TO insure consistently good recordings, preventive attention should be given to the possible problems before they occur. First check carefully alignment of the lead screw assembly and its working parts. Be sure there is no binding of any of the gears, however slight, as it will cause wow. It is feasible to use a little grinding compound to lap the gears into a perfect fit. Of course, this should be done cautiously, or excessive play will be produced.

Be sure the cutter carriage moves smoothly and contains no excessive oil. Be certain there is no play in the cutter mount bearings, as even a small amount may cause bouncing of the cutting head—see Photo A for example of the results. It should move freely in a vertical direction, so as to follow—without variation in cutting depth—the contour of a slightly warped blank.

After you are sure the mechanism is operating properly, adjust the motor drive (if it is adjustable) until it delivers sufficient power without excessive vibration. Adjusting the motor too tightly against the idler wheels on a rim-drive recording motor causes transmission of excessive vibration and also a slight reduction in the speed of the turntable. Be sure that the rubber idler wheels are clean and free from oil—see Photo B. They should not be over-oiled. If they need cleaning, use carbon tetrachloride or gasoline. Be sure also that the turntable rim is smooth and clean. Even a small insect mashed against it can cause considerable noise and wow.

The cutting needle

The next important consideration is the insertion of the cutting needle in the head. Sapphire and stellite needles are the types to use; sapphires will yield slightly quieter recordings and will last several times longer. They come in two lengths and it is necessary to choose the proper needle as specified by the manufacturer of your cutter.

The needle should be inserted into the chuck as far as it will go, with the flat on the needle shank pointing forward where it will be engaged by the set-screw. The flat side of the cutting point should face *the back of the cutter head*. The angle of this flat with the surface of the disc should be approximately vertical. The angle varies between 88 and 90 degrees. There is a particular angle which will produce the quietest cut with any individual needle. This angle can be found by making test cuts with no groove modulation and observing the noise by playing back the blank groove.

The easiest way to observe when the needle is vertical is to lower the cutter on a blank disc and observe the reflection in the surface of the disc. Compare the reflection with the needle (see Photo C). A slight deviation from vertical can be readily noted. *Warning:* Be sure that the needle does not point even a fraction of a degree toward the turning record as it will immediately dig into the record, which will inevitably tear off the point of a sapphire stylus. The angle of the stylus is changed by raising or lowering the cutting head on some record-

ers, and by moving the needle in and out of the chuck on others.

Cutting the record

When the angle is properly adjusted, the depth of cut should be regulated so that a 60-40 relation exists between groove and land. The rule of thumb is: make the cut as light as possible, consistent with the playback pickup's ability to track the resulting recording. The chip should throw from the needle at an angle and lie flat on the disc at least $\frac{1}{4}$ -inch from the stylus (see Photo D). The stylus is designed to throw the chip

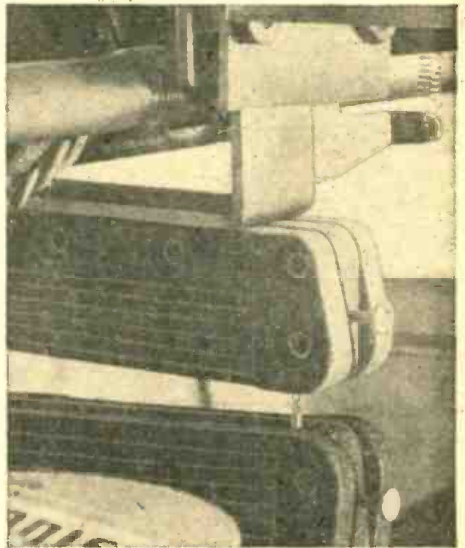

Photo C—Alignment of needle and reflection.

away from its point. If it does not, it should be replaced or twisted in the chuck slightly.

The chip should approximate a human hair in thickness and should be about 0.002-inch in width and depth. The average playback stylus has a tip with a 0.002 to 0.0025-inch radius. It is de-

(Continued on page 64)



Photo A—The uneven grooves near the edge indicate pickup bounce.



Photo B—A bottom view of the equipment, showing rim-drive idlers.

Transatlantic News

From our European Correspondent, Major Ralph Hallows



THEY spell it with small letters: ffr. It stands for full frequency range recording.

More important still, it stands for full range frequency reproduction; for it is one thing to cut on a wax disc spiral grooves which record the whole range of audible frequencies and quite another, as we shall see, to find a way of making a phonograph reproduce everything that is put on to the wax. I admit freely that when I first heard of ffr I was not greatly excited. I am much too old a bird of the radio and phonograph worlds to flutter blindly into decoys baited with sales talk about "The Very Soul of Music," "Reproduction That Is Real," "Every Sound in the Studio Brought to Your Home" and that kind of thing. On investigation the perfect

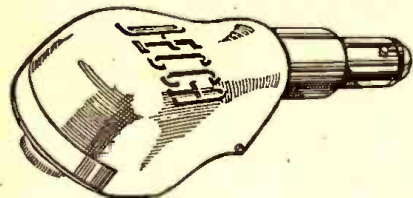

Fig. 1—Pickup is $1\frac{3}{4} \times \frac{3}{4} \times \frac{5}{8}$ inches.

reproduction promised is too often found to depend upon a.f. amplifiers with a complete cut-off at or below 5,000 cycles, a false bass produced by cabinet and other resonances, and harmonic distortion—second and (far more distressing) third—ranging from 10 to 15 percent or more.

I am the first technical writer to have the opportunity of investigating the British Decca ffr system. I approached the investigation in a distinctly sceptical frame of mind, but before it was ended I was convinced that they have tackled the problems of the phonograph in an entirely new way and that they have achieved improvements so outstanding that they may almost be classed as revolutionary.

The main defects of the phonograph as we now know it may be summarized as follows:

1. Surface noise, or needle scratch spoils the beauty of music by its annoying background.
2. Even the best of ordinary records deal very poorly with the upper audio frequencies.

3. Transients, such as the sounds of tympani, *pizzicato* on strings, or the clean-cut notes of the cornet are not realistically reproduced.
4. Transients, in fact, are often reproduced as very unpleasant sounds, jarring on the ear.
5. Sound contrasts are unduly compressed: the phonograph is very far from bringing out the real contrasts between *fff* and *ppp* that actually occur in the course of an orchestral performance.
6. The reproduction distorts, sometimes very unpleasantly, the sounds of music.

Believe it or not, most of the six defects enumerated have one and the same origin: surface noise. It has long been realized that surface noise was one of the greatest enemies of the phonograph; but not until these recent researches were made was the extent of its evil influence fully grasped.

Surface noise consists of impulses giving rise to purely random waveforms, which cannot be analyzed into any combination of sine waves. It is, in fact, the sound-wave counterpart of static and its effects on a pickup are similar to those of static on an antenna. Static, as you know, shock-excites an antenna, causing it to oscillate at its natural frequency. Surface noise shock-excites a pickup making it produce a strong response at any frequency at which it has a resonance.

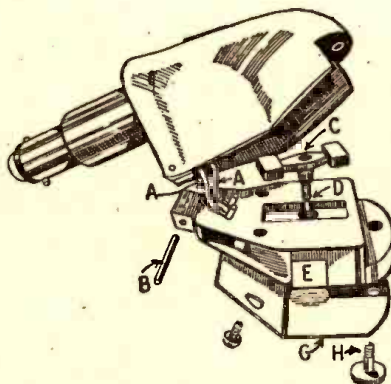

Fig 2—Pickup exploded. A—leads from coil; B—hinge pin; C—rubber mount for armature; D—the armature; E—magnet; G—cover plate.

The response curves of most pickups show marked resonance peaks well within the audio frequency range and

usually towards the upper limit of their compass. For that reason they reproduce surface noise as a high-pitched hissing sound. Besides its unpleasantness this hiss is sufficiently strong to drown the upper audio frequencies when the recording level of sound is low. Hence it has been necessary when making recordings to monitor severely, keeping the sound level of the music always above that of the noise; in other words contrast compression must take place in the recordings.

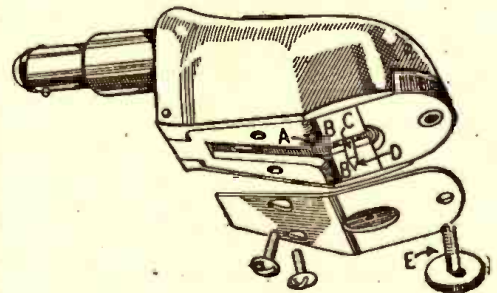

Fig. 3—Bottom view. A—coil; B—magnets; C—armature; D—sapphire; E—milled screw.

Until comparatively recently no record contained any worthwhile amount of frequencies above 5,000 cycles and few radio phonographs were able to bring out audio frequencies even as high as that. The reason is simply that a better response at the upper end of the scale would have meant giving greater prominence to surface noise hiss.

In theory the proper reproduction of transients can be obtained only if all the harmonics right up to infinity are present. In practice perfectly acceptable reproduction is had if the harmonics within the audible range—say up to 15,000 cycles—are brought out. But transients sound unreal and lose their characteristic crispness if there is a cut-off much below 15,000 cycles. With its 5,000-cycle cut-off the radio-phonograph cannot do them justice. And matters are often made far worse by the listener's use of the tone control. In self-defence against the hiss which he dislikes the listener often turns the knob as far as it will go, producing in some cases a cut-off as low as 3,500 cycles.

You will see now how strongly surface noise militates against good reproduc-

(Continued on page 66)

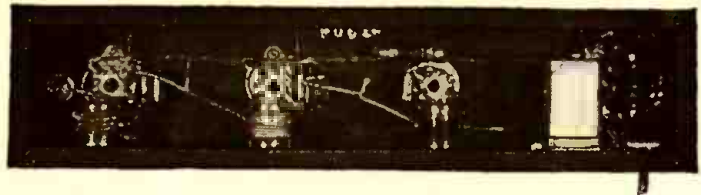

Top and bottom views of frequency-modulated transmitter. Coils are efficiently placed to keep oscillator and multiplier leads short.

Demonstration Transmitters

By HAROLD McDUFF and GEORGE PYLE*

WHAT is FM? This is the question most frequently asked by the general public whenever the subject of broadcasting is discussed. To answer this question the FM demonstration unit shown in Fig. 1 was constructed. Although there are a number of FM applicants in the Peoria area, there was no immediate prospect of any FM signals for receiver demonstration.

Two miniature units, one the FM and the other the AM, were designed and constructed, using the same tube complement so far as possible on identical chassis 17 x 4 x 3 inches, using similar short whip antennas, and powered by a common power supply to present practically an identical appearance. The power output of the two transmitters was adjustable so that equivalent signals at the receiver terminals could be obtained. Program material consisting of wide-range electrical transcriptions originating in one of the radio station's control rooms was transmitted continuously over an equalized telephone line to the demonstration point and fed simultaneously to each transmitter. Although these units were built as simply as possible, using standard parts, certain problems had to be solved.

The schematic diagram of the AM unit is shown in Fig. 2. It consists of a tunable oscillator coupled to an amplifier stage and modulated by a pair of 6J5 tubes in parallel. Since there are no modulation transformers available for this tube complement, modified Heising modulation was employed.

The coils were made from Barker-Williamson Miniductors Type 316. The oscillator had 55 turns, tapped 20 turns from the grid end. The tank coil consisted of 70 turns, on which the antenna was tapped by experiment. Fixed mica condensers resonated the coils at a clear spot in the broadcast band.

The FM unit shown in Fig. 1 employs

a reactance modulator working with a 6C5 oscillator on 5 mc which is tripled twice to 45 mc, the output frequency employed. The old-band FM receivers can pick up the fundamental output frequency, and a harmonic of this is

uses 4 turns, of No. 20 d.c.c. spaced to $\frac{1}{8}$ inch. A 1-turn coil couples this to the antenna. The oscillator coil is tapped at 9 turns from the grid end.

For reception, one of the automatic tuning buttons of the demonstration re-

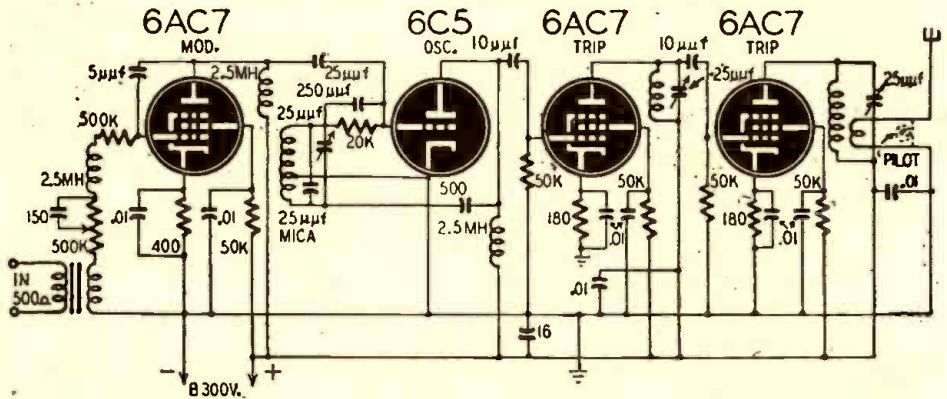

Fig. 1—The FM transmitter. This 4-tube job might serve as a model for amateur excitors.

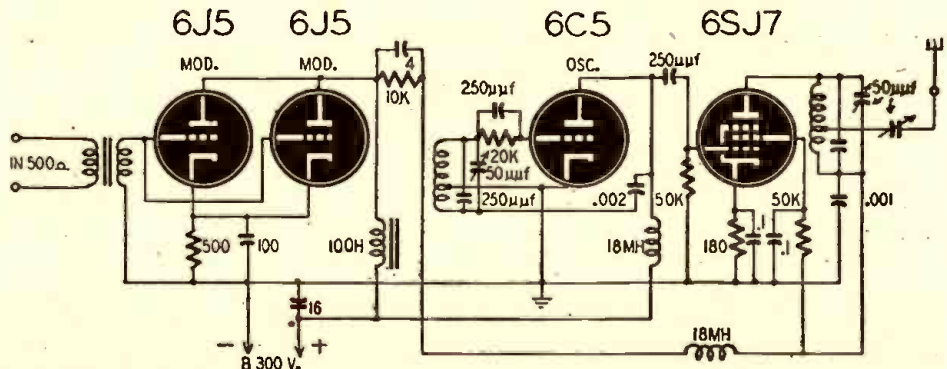

Fig. 2—Schematic of the AM unit, used to supply a signal to a receiver a few feet away.

used if the receiver has only the new 100-mc band.

The FM unit coils were all wound on 1-inch diameter tubing. The oscillator coil was close-wound with 27 turns of No. 28 enamelled wire, the first tripler with 9 turns of No. 22 d.c.c. spaced to $\frac{1}{8}$ inch and the second tripler

ceiver was adjusted to the frequency of the AM unit, while the manual tuning control was tuned to the FM signal. Thus changing the FM-AM selector switch on the receiver picked up whichever transmitter was desired, leaving no other adjustments to be made, at

(Continued on page 53)

The AM unit resembles its FM opposite number closely, excepting for component sizes. The output is ample for short-range demonstrations.



TELEVISION FOR TODAY

PART XIII—Problems of the cathode-ray tube

By MILTON S. KIVER

THE cathode-ray tube in the television receiver is comparable to the loudspeaker in the sound receiver. It is much more intricately tied in with the operation of the television set than the loudspeaker is with its receiver. Such factors as operating controls, sources of high voltage, and methods of focusing and deflection require careful adjustment if a good image is desired.

The basic operation of the cathode-ray tube has been described many times in literature. To repeat a principle briefly, the electrons emitted by the cathode are formed into a high-velocity beam by electrostatic or electromagnetic means, or both, and then projected at the fluorescent screen. The beam is deflected electrostatically with deflection plates or electromagnetically with de-

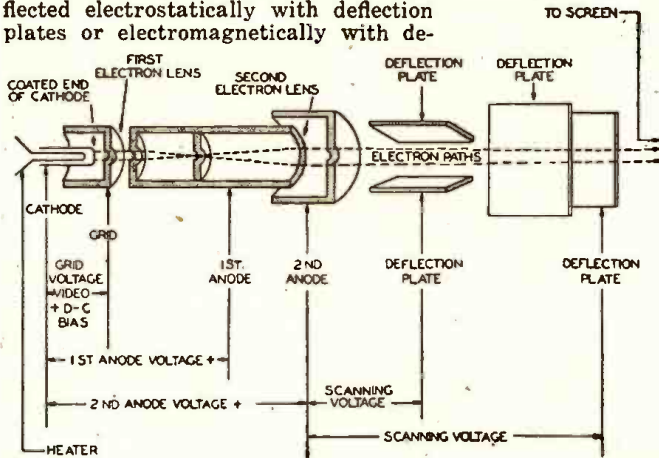

Fig. 1—Semi-perspective view of components of a cathode-ray tube.

flection coils. Fig. 1 shows the inside structure of a typical electrostatic deflection tube. For electromagnetic deflection, the plates are omitted.

The most acceptable screen for television is one which emits white light when excited by an electron beam. This does not exclude screens emitting light of other colors, for some of these have been and are being used. However, black-and-white images are considered less fatiguing for the eyes, especially for long-sustained viewing periods. The already familiar motion picture also played an important part in the choice of this set of color values.

An electron gun, once constructed, can be subjected to considerable misuse without being permanently affected. On the other hand, failure to grasp the significance of certain precautions required to protect the fluorescent screen can readily result in a shortened period of usefulness as well as unsatisfactory operation throughout the life of the tube.

A tabulation of the most common phosphors in use in oscilloscopes, tele-

vision receivers, and radar equipment is shown in Table 1. For television, a combination of zinc sulphide and zinc beryllium silicate is used, this combination giving higher conversion efficiency than most other known compounds. It is interesting to note that the electron beam remains at any one point for only approximately 0.1 microsecond, yet the light emission continues for two to three hundredths of a second, indicating that the zinc sulphide and zinc beryllium silicate are responsible through their phosphorescence for essentially all of the emitted light seen by the observer. Fig. 2 is a zinc sulphide persistence curve.

The principal object in designing a cathode-ray tube is to produce an image having good brightness and high contrast.

When the electron beam strikes the back of the fluorescent screen, the light which is emitted distributes itself in the following approximate manner:

1. 50 percent of the light travels back into the tube.
2. 20 percent of the light is lost in the glass of the tube by internal reflection.
3. Thirty percent reaches the observer.

Thus, of all the light that is produced by the electron beam (and this itself is a highly inefficient process), only 30 percent reaches the observer.

Image contrast also is impaired because of interference caused by light which is returned to the screen after it has been reflected from some other

point. Some of these sources of interference, listed in order of importance, are:

1. Halation
2. Reflections due to screen curvature.
3. Reflections at the surface of the screen face.
4. Reflections from inside the tube.

Effects of halation

If we examine minutely the light pattern produced by a stationary electron beam in a cathode-ray tube, we find that the visible spot is surrounded by rings of light. These rings of light are due to halation. See Fig. 3. The light rays which leave the fluorescent crystals at the inner surface of the tube face travel into the glass and are refracted. Those rays which make an angle greater than ϕ do not leave the glass when they reach the outer surface, but instead are totally reflected back into it. At each point where these reflected rays strike the fluorescent crystals, they scatter. It is this scattering of the rays that produces visible rings on the screen. These rings cause a hazy glow in the region surrounding the beam spot and reduce the maximum possible detail con-

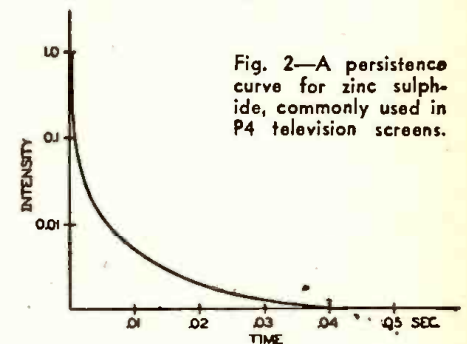

Fig. 2—A persistence curve for zinc sulphide, commonly used in P4 television screens.

trast. Contrast, it will be remembered, is the ratio of the brightness of two areas, one of which is being bombarded

by the electron beam, the other not. This ratio should be as high as possible to have "rich-looking" or high-quality images. Due to the scattering of the light, however, areas which should be in total darkness receive some light. The result is a reduction in the contrast ratio. A distinction is usually made between

TABLE I

RMA Designation—Substance	Activator	Fluorescent Color	Phosphorescence (seconds)
P1—Zinc silicate	Manganese	Green	Med. -0.03-0.05
P2—Zinc sulphide	Copper	Blue-green	Long
P3—Zinc beryllium silicate	Manganese	Yellow-Gr.	Med. -0.05'
P4—P3 and zinc sulphide	Silver	White	Short 0.005
P5—Calcium Tungstate		Blue	Very short 5 μ sec. med. 0.005
P6—Zinc sulphide Zinc cadmium sulphide	Silver Silver	White	
P7—Zinc sulphide Zinc cadmium sulphide	Silver Copper	Blue Yellow	Med. -0.006 Long
P11—Zinc sulphide	Silver with a nickel quencher	Blue	Very short 10 μ sec.

the detail contrast ratio, which is defined on opposite page, and the over-all field contrast, which compares two sections of the screen which are widely removed from each other. Halation affects only detail contrast.

Screen curvature reflections

Loss in contrast due to reflections arising from the curvature of the screen is shown in Fig. 4. The remedy for this is to use a flat screen. Many adaptations in this direction have been made, since the screen curvature greatly restricts the useful image area. One example is the large 20-inch tube television sets currently being offered to the public by one prominent manufacturer. A good portion of the image is, in this writer's opinion, useless because of the optical distortion introduced by the screen curvature. A flat-face 10-inch tube seems preferable to the 20-inch curved screen.

Reflections from screen surfaces

Light rays, when they travel from one medium to another, lose a certain amount of energy at the intersection of the two media. At the cathode-ray tube screen, some light is reflected when it reaches the dividing surface between the air and the glass of the tube. The reflected light travels back to the inner surface and then back to the outer surface again. At each dividing surface, some of the light continues onward and some is reflected back into the glass. Absorption and dispersion quickly reduce the strength of these rebounding rays.

In Fig 5-a we see how reflections from the inside surfaces of the tube can act to decrease the field contrast of the image. The loss in contrast from this source of interference can be made low

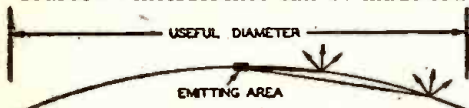

Fig. 4—Diffusion effects in non-flat screen.

by special shaping of the bulb walls, as shown in Fig. 5-b, and by the use of black aquading coating. The latter coating is also useful for electrical purposes, acting as a shield and a path for the return of the secondary electrons emitted from the fluorescent screen.

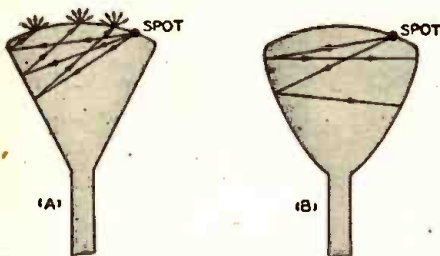

Fig. 5—How internal reflections are reduced.

A recent step toward improving screen brightness and contrast has been the addition of an extremely thin film of aluminum on the back of the fluorescent screen. The film is sufficiently thin to permit the electrons in the scanning beam to reach the fluorescent crystals. It will, however, prevent any of the light

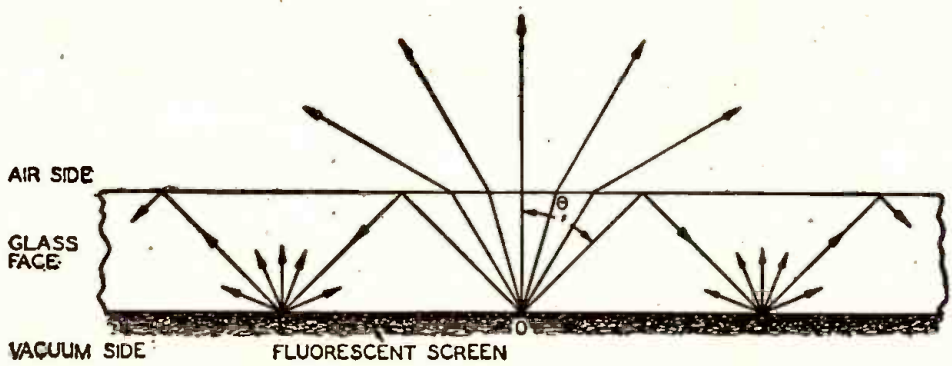

Fig. 3—Illustrating how reflections between the two sides of the glass can cause halation.

generated by the screen crystals from traveling back to the tube. This is shown in Fig. 6. The light which previously went back into the tube is now reflected toward the observer.

The metal film is extremely thin, in the order of $3,500 \times 10^{-8}$ centimeters thick. Since even a layer this thin does interpose a barrier in the path of the electron, high accelerating voltages must be used. In Fig. 7, the efficiency curves of screens having the metallic layer and those which do not are compared. At low accelerating voltages, the energy lost by the electrons in penetrating the layer decreases their efficiency below that of similar electrons in tubes without this layer. The poorer efficiency continues until we reach the point where the curves intersect.

Beyond this region, the screen with the metallic layer is much superior to the ordinary tube. The rapid rise in efficiency is due to a decrease in energy lost at the metallic barrier plus an increase in the over-all brightness due to the light-resisting characteristics of the layer itself.

A matter of considerable importance is the elimination of the ion spot in tubes using electromagnetic deflection. No matter how carefully a tube is degassed or how well the cathode coating is applied, ions will be present in the electron beam. These ions are either gas molecules which have acquired an electron, or else molecules of the outside coating material of the cathode. The ions have the same charge as the electrons and are sensitive to the same accelerating voltages. In tubes employing electrostatic deflection, the ions and the electrons are similarly deflected and for all practical purposes may be considered as one. However, when electromagnetic deflection is employed, it will be found that these heavier ions are barely deflected. Consequently, they tend to strike the center of the screen in a steady stream and produce a thin film of deactivated material on the area exposed. When the electrons in the scanning beam pass over this area no light is produced.

To the observer this appears as a dark patch.

Several methods for preventing the ions from reaching the screen are in current use. First there is the bent electron gun, as shown in Fig. 8. Ions and electrons emitted by the cathode are accelerated to the first and second anodes. However, the cathode is inclined at an angle to the rest of the gun structure,

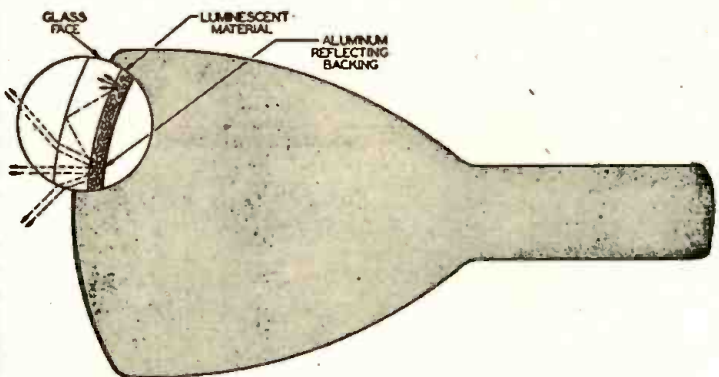

Fig. 6—Aluminizing the screen concentrates all the light forward.

and both particles, if permitted to travel in a straight line, would impinge on the side of the electron gun and never reach the screen. If a strong magnetic field is placed in the path of the particles, it is possible to alter the paths of the electrons sufficiently to have them travel toward the screen. The heavier ions, however, are not sufficiently deflected. As a result, they hit the side of the electron gun. The magnetic field which

(Continued on page 57).

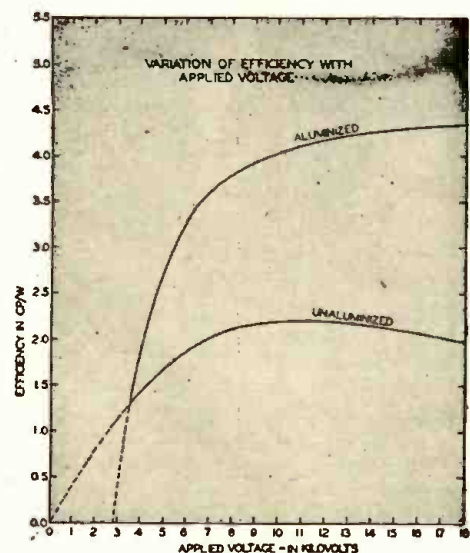
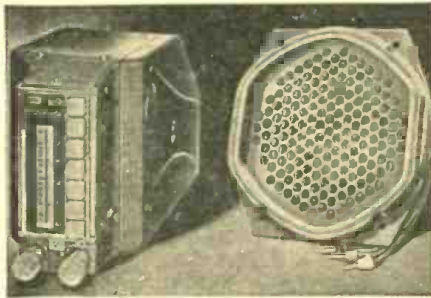

Fig. 7—Effect of aluminizing on efficiency.

RADIO DATA SHEET 347

MOTOROLA AUTO RADIO 1946 MODEL CR6



TUNING RANGE
535 to 1600 Kc.

OVERALL SENSITIVITY

Frequency 1400 Kc., 1000 Kc., 600 Kc.
Sensitivity 1.5 μ v. 1.5 μ v. 1.0 μ v.
Standard output is to be 1 watt and is measured across the 3-ohm resistive load. (1 watt = 1.74 volts). Test is made with 30 percent 400-cycle modulation. Tone control is set to VOICE position and volume control at maximum.

ELECTRICAL CHARACTERISTICS

Power input: 10 amperes at 6.3 volts
(including speaker field)
Power output: 9 watts

TUBE COMPLEMENT

- 1 6SK7-GT R.f. amplifier
- 1 6SA7-GT Oscillator-Modulator
- 1 6SK7-GT I.f. amplifier
- 1 6SQ7-GT Detector-a.v.c.-a.f. amplifier
- 1 6SQ7-GT Audio inverter
- 2 6V6-GT Push-pull power amplifier
- 1 OZ4 or 6X5-GT Rectifier

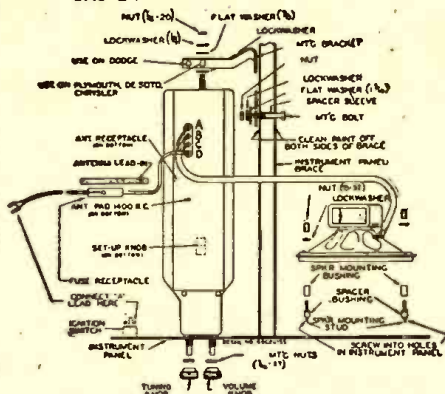

Installation diagram. A—speaker field, yellow; B—voice coil, white; C—ground, black; D—battery.

ALIGNMENT TABLE

STEP	TUNER POSITION SET TO	DUMMY ANTENNA	SIGNAL GENERATOR LEAD CONNECTED TO	SIG. GEN. SET AT	ADJUST FOR PEAK ON OUTPUT METER
1.	High frequency end (cores out)	0.1 μ f at Sig. Gen.	Oscillator-Modulator grid (#5 pin)	455 kc	Primary and secondary of T-1 Primary and secondary of T-2
2.	High frequency end, tuning shaft against stop. Cores should be set to project 1/8 inch from cans.	60 μ f at Sig. Gen. in series in 21-inch coaxial lead.	Antenna receptacle	1600 kc	Oscillator trimmer (across L-3) R.f. trimmer (across L-2) Antenna trimmer (across L-1)
3.	EXACTLY one full turn in from high frequency end. Use knob set screw as an indicator. Start measuring turn the moment tuner carriage starts moving inward.	"	"	1425 kc	Oscillator core of L-3 R.f. core of L-2 Antenna core of L-1
4.	EXACTLY four more full turns in (as indicated by knob setscrew)	"	"	Power turned OFF	Oscillator pad core of L-4 for maximum noise.
5.	Assemble and install receiver in car and connect car antenna. Turn the dial to approximately 1400 kc (not to a local station) and adjust antenna trimmer for maximum noise. This adjustment is referred to as Antenna Padder in receiver installation detail figure. NOTE: If oscillator padder core adjustment is too far off, repeat alignment procedure, steps 2, 3, and 4. It may be necessary to repeat alignment more than once if padder adjustment has been indiscriminately tampered with.				

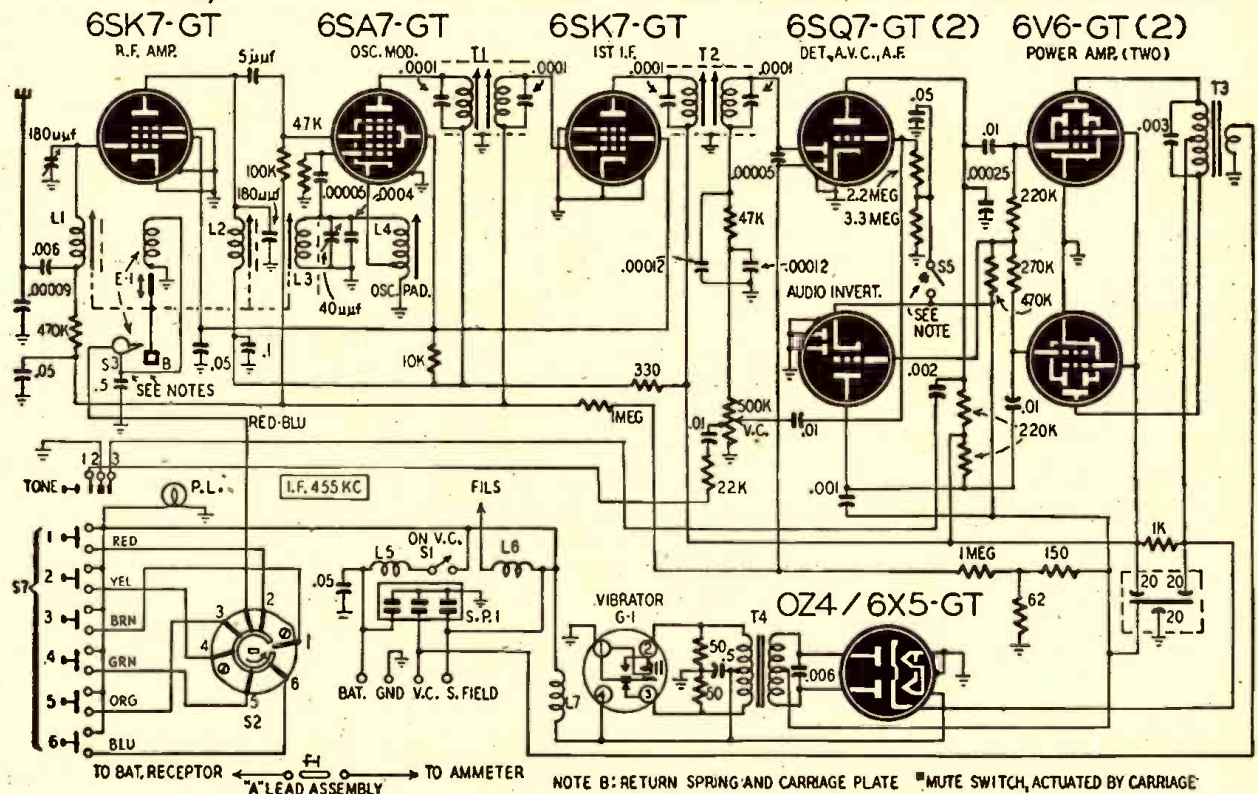

NOTE B: RETURN SPRING AND CARRIAGE PLATE MUTE SWITCH, ACTUATED BY CARRIAGE

SENSATIONAL VALUE

BUILD YOUR OWN VOLT-OHM-MILLIAMMETER

and save!!

The Model-KT 20 kit provides ALL components, including meter, panel, cabinet, resistors, condensers, tip jacks, control, selector switch, copper oxide rectifier, pre-cut wires—in fact every component and part needed to complete the unit.

Complete kit including ALL PARTS assembled and ready for wiring, circuit diagram, easy-to-follow instructions and detailed operating data for the completed instrument.



THE KIT COMES COMPLETELY ASSEMBLED. Can be wired in 15 minutes. Components and circuit guaranteed to meet the following specifications:

- 4 A.C. VOLTAGE RANGES:
0-15/75/300/1500 volts.
- 4 D.C. VOLTAGE RANGES:
0-15/75/300/1500 volts.
- 2 D.C. CURRENT RANGES:
0-15/150 MA.
- 2 RESISTANCE RANGES:
0-10,000 ohms; 0-1 Meg.

\$950
NET



THE NEW MODEL B-45

SIGNAL GENERATOR

Complete, ready to operate. . . . **\$275**

Self-modulated — provides a highly stable signal. RF frequencies from 150 Kc. to 12.5 Mc. on Fundamentals and from 11 Mc. to 50 Mc. on Harmonics.

Modulation is accomplished by grid-blocking action — equally effective for alignment of amplitude and frequency modulation as well as for television receivers. Self-contained batteries. All calibrations are etched on the front panel, permitting DIRECT READING.

Model B-45 uses a beautifully processed dualtone front panel. Comes housed in a heavy-gauge crystalline steel cabinet complete with shielded test lead, self-contained batteries and instructions.



THE NEW MODEL 670

SUPER METER \$28⁴⁰

A Combination VOLT-OHM-MILLIAMMETER plus CAPACITY REACTANCE, INDUCTANCE and DECIBEL MEASUREMENTS

D.C. VOLTS: 0 to 7.5/15/75/150/750/1500/7500.
A.C. VOLTS: 0 to 15/30/150/300/1500/3000 Volts.
OUTPUT VOLTS: 0 to 15/30/150/300/1500/3000.
D.C. CURRENT: 0 to 1.5/15/150 Ma.; 0 to 1.5 Amps.

RESISTANCE: 0 to 500/100,000 ohms 0 to 10 Megohms.
CAPACITY: .001 to .2 Mfd., .1 to 4 Mfd. (Quality test for electrolytics).
REACTANCE: 700 to 27,000 Ohms; 13,000 Ohms to 3 Megohms.
INDUCTANCE: 1.75 to 70 Henries; 35 to 8,000 Henries.
DECIBELS: -10 to +18, +10 to +38, +30 to +58.
The Model 670 comes housed in a rugged, crackle-finished steel cabinet complete with test leads and operating instructions. Size 5 1/2" x 7 1/2" x 3".



THE NEW MODEL CA-11

SIGNAL TRACER \$18⁷⁵

Simple to operate . . . because signal intensity readings are indicated *directly on the meter!*

- ★ SIMPLE TO OPERATE — only 1 connecting cable — NO TUNING CONTROLS.
- ★ HIGHLY SENSITIVE — uses an improved Vacuum Tube Voltmeter circuit.
- ★ Tube and resistor-capacity network are built into the Detector Probe.

- ★ COMPLETELY PORTABLE — weighs 5 lbs. and measures 5" x 6" x 7".
- ★ Comparative Signal Intensity readings are indicated directly on the meter as the Detector Probe is moved to follow the Signal from Antenna to Speaker.
- ★ Provision is made for insertion of phones.

The Model CA-11 comes housed in a beautiful hand-rubbed wooden cabinet. Complete with Probe, test leads and instructions.



THE NEW MODEL 450

TUBE TESTER \$39⁵⁰

Speedy operation — assured by newly designed rotary selector switch which replaces the usual snap, toggle, or lever action switches.

SPECIFICATIONS

- Tests all tubes up to 117 volts.
- Tests shorts and leakages up to 3 Megohms in all tubes.
- Tests individual sections such as diodes, triodes, pentodes, etc., in multi-purpose tubes.
- Noise Test — detects microphonic tubes or noise due to faulty elements and loose internal connections.
- Uses a 4 1/2" square rugged meter.
- Works on 90 to 125 volts 60 cycles A.C.

EXTRA SERVICE — May be used as an extremely sensitive condenser Leakage Checker. A relaxation type oscillator incorporated in this model will detect leakages even when the frequency is one per minute.

OUR POLICY

We do not advertise any unit which is not available for immediate shipment from stock. • Less flowery adjectives, more detailed specifications. • All units are sold subject to one year guarantee except when components are damaged through misuse. • We do

not solicit orders for any unit that does not meet our requirements for accuracy and honest value. Any item purchased from us is sold with the understanding that it may be returned for full refund after a 10 day trial.

20% DEPOSIT REQUIRED ON ALL C.O.D. ORDERS

GENERAL ELECTRONIC DISTRIBUTING CO.

DEPT. RC-6, 98 PARK PLACE, NEW YORK 7, N. Y.

(Present-day B & W receivers of the direct-viewing type and using a 10-inch cathode-ray tube employ 30 tubes, thus the sequential color receiver compares favorably in the number of tubes.

A disadvantage of the sequential receiver is that it is not possible to pick up color images broadcast by the *simultaneous* system (without special design of the receiver).

The receiving aerials used to pick up the sequential color images were of simple design; in many tests a double-horn type proved efficient, dipole antennas being placed at the focus of the parabolic horns. The horns were made of latticed wire in some instances.

RCA simultaneous color system

In the simultaneous electronic system demonstrated by RCA the three basic colors (red, blue, and green) are transmitted all at the same time and continuously. No moving parts such as revolving color filters are used, the operation being fully electronic. Fig. 1-b and Fig. 2-b show how 3 separate carriers carry the three colors. The total band width of the 3 carriers is only 14.5 mc. (In a special test this was

COLOR TELEVISION

(Continued from page 21)

reduced to 12.5 mc.) Sound is transmitted on a relatively narrow band (a subcarrier of 524.1 mc), along with the video signals, as the figure makes clear.

At the transmitter, the film (or *live* subject) is scanned by a beam from a kinescope tube. After scanning the picture or subject, the beam is focused through a lens onto a system of semi-transparent mirrors and 3 photocells (Photo D). Each photocell picks up its respective color component and modulates the corresponding carrier.

For picking up *live* subjects a *flying spot* from a kinescope tube scans the scene, the reflected beam falls on a system of dichroic (color-selective) mirrors, which reflect the respective color components onto 3 photocells. These cells in turn modulate the 3 carriers used to transmit the signals. See diagram Fig. 1-b.

Each of the transmitted red, blue, and green images has the same number (525) of scanning lines and also the same horizontal scanning rate and picture repetition frequency of 30 per second, as in present B & W broadcasting.

At the receiver each carrier, modulated respectively by the red, blue, and green signals, is tuned in through separate band-pass circuits and ampli-

fiers. One tuning control may be used to tune in the video signals. The 3-color signals are next fed into their respective cathode-ray tubes (each about 3 inches in diameter) on the ends of which appear the 3 images: one in red, one in blue, and the third in green. Each tube is made with a different phosphor on the screen which will respond to one color, one tube for the red, one for the blue, etc.

Magnifying lenses are placed in front

(Continued on page 56)

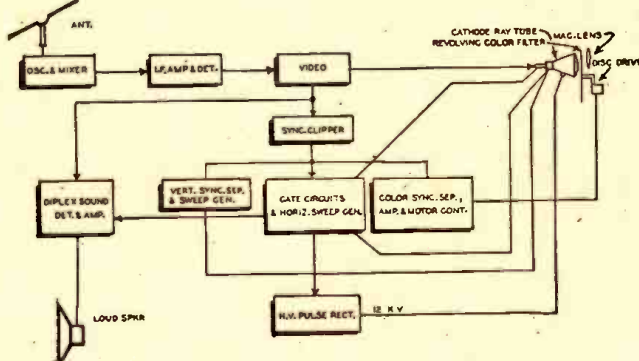

Fig. 4—A block diagram of the CBS color television receiver.

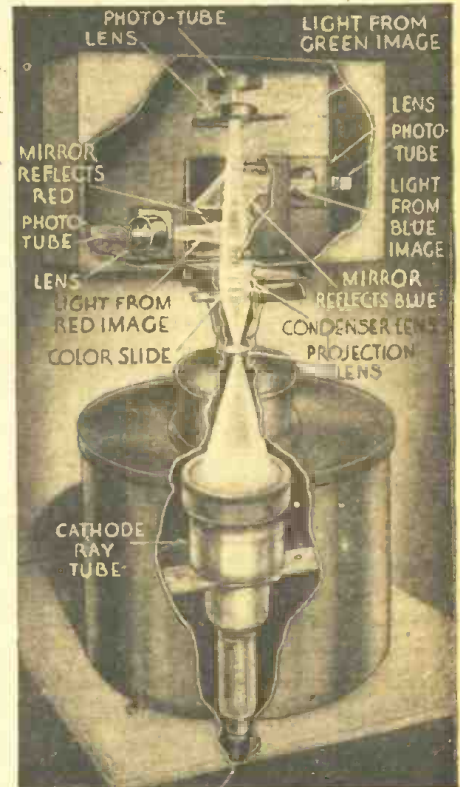

Photo D—Simultaneous system color analyzer.

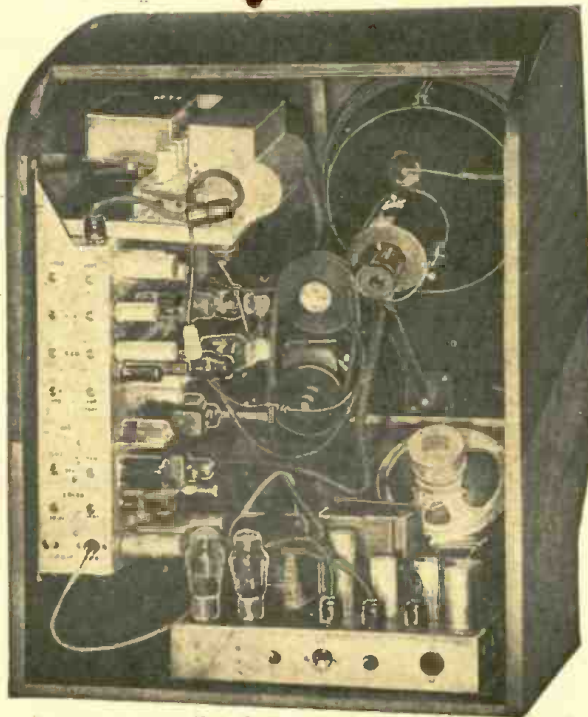

Photo B—CBS television receiver, rear view.

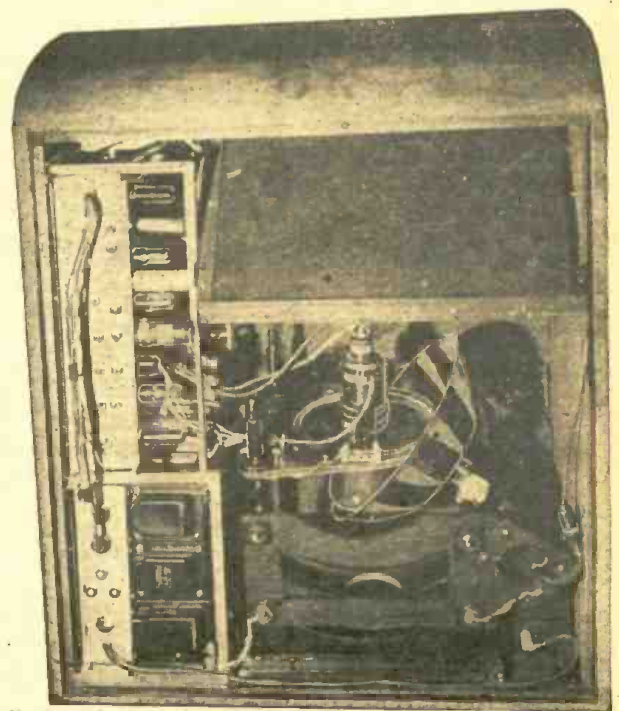

Photo C—The CBS projection color receiver.



Amazing Bargain Offer in Diagram Manuals

ALL NEW 1947 CIRCUITS | SERVICE DATA YOU NEED TO GET AHEAD

Be prepared to repair quickly all new 1947 sets. In this big single volume you have clearly printed, large schematics, needed alignment data, replacement parts lists, voltage values, and information on stage gain, location of trimmers, and dial stringing, for almost all sets released between June 1, 1946, and March 1947. A worthy companion to the six previous volumes used by over 100,000 shrewd radio servicemen. There is no need to spend large sums for bulky, space-wasting manuals or to buy additional drawings every few weeks—get this low-priced new SUPREME PUBLICATIONS manual and you have all service information on popular 1947 sets. Covers 327 models of 52 different manufacturers. Large size: 8½ x 11 in., 192 pages + index. Manual style binding..... **\$2.00**

Speed up and simplify all radio repairs with the inexpensive SUPREME Manuals. Service radios faster, better, easier, save money and time, use these most-often-needed diagram manuals to get ahead and earn more per hour. At unbelievable low cost (only \$2 for most volumes) you are assured of having in your shop and on the job, needed diagrams and other essential repair data on 4 out of 5 sets you will ever service. Every popular radio of every make, from old-timers to new 1947 sets, is included. Clearly printed circuits, parts lists, alignment data, and helpful service hints are the facts you need to improve your servicing ability. Save hours each day, every day, let these seven volumes furnish diagrams for 80% of all sets. See pictures of these attractive manuals above. Each volume has between 192 and 240 pages, large size 8½ x 11 inches. Manual style binding. Send coupon today. Complete satisfaction guaranteed.

Most Popular Models Made by:
 R.C.A., Zenith, Philco, Sears, Fada, Emerson, Belmont, Detrola Radio, United Motors, G.E., Westinghouse, Arvin, Majestic, Stewart-Warner, Admiral, Delco, Stromberg-Carlson, Western Auto, Sparton, Motorola, Wards, Gamble, and many others.

Post-War Automatic 1945-1947 Record Changers
 Service expertly all new (1945-1947) record changers. Follow simplified factory instructions to make needed adjustments and repairs. Hundreds of photographs and exploded views; thousands of test hints; service instructions for all popular makes. Large size: 8½ x 11", 144 fact-filled pages. At your jobber or post-paid, only **\$1.50**

Pre-War Record Players, Changers, & Recorders
 Just what you need to repair quickly thousands of pre-war automatic record changers, manual units, pick-ups, wireless oscillators, recorders, and combinations. Hundreds of mechanical and electrical diagrams. Instructions for adjustments and repairs. Most popular units of all makes. 128 large pages. 8½ x 11 inches. Price, only **\$1.50**



Compiled by M. N. Beitman, radio engineer, teacher, author, & serviceman.

NO RISK TRIAL ORDER COUPON

SUPREME PUBLICATIONS, 9 S. Kedzie Ave., Chicago 12, ILL.
 Ship the following manuals: (Money back guaranteed)

1947 1946 1942 1941 1940 1939 1926-1938
 L. Price each volume only \$2.00, postpaid \$2.50

Post-War Automatic Record Changers, \$1.50.
 Pre-War Record Players, Changers, & Recorders, \$1.50.

I am enclosing \$..... send postpaid.
 Send C.O.D. I am enclosing \$..... deposit.

Name:
 Address:

See Your Radio Jobber or Send →

Supreme Publications
 PUBLISHERS OF RADIO BOOKS, MANUALS, AND DIAGRAMS
 9 S. KEDZIE AVE. CHICAGO 12, ILL.
 RADIO-CRAFT for JUNE, 1947

Never so much radio for so little money —

\$10⁹⁵

Including Tubes
Postpaid in U. S. A.

**SUPER-HETERODYNE
FOUR TUBES and
SELENIUM RECTIFIER
110 Volt AC-DC KITS**
direct from factory
to you —

Never before has BELLTONE packed so much quality and value in a \$10.95 complete package. This four tube and selenium rectifier super-het kit of parts (chassis 10 1/2" x 5 1/2" x 7") has proven its selectivity, sensitivity and high quality radio reproduction in tens and tens of thousands of receivers sold during the past months. Today you can have this same chassis with all

post-war improvements

at virtually cost of component parts, drawings, instructions, packing and mailing costs —complete except for cabinet, wire and solder.

three big assembly and
hook-up prints and
ABC detailed instructions
supplied

Including schematic circuit, picture wiring diagram, top chassis layout, dial cord instructions and cabinet layout suggestion—makes assembly, wiring and final adjustments easy, instructive and foolproof.

direct from factory to you
only — no sales to jobbers,
dealers or surplus outlets

no cabinet, wire or solder supplied



circuit improvements and parts include —

1. **SELENIUM RECTIFIER** — eliminates troublesome rectifier tube—it's unbreakable—lasts the lifetime of your set—starts instantly—increases sensitivity.
2. **PROTECTIVE FILAMENT RESISTOR**—prevents current surge through filaments—eliminates tube burn-outs and increases tube life.
3. **ALNICO PM SPEAKER**—1.47 ounce 5 inch speaker for high quality voice and music reception.
4. **GRIP-STRAIN RELIEF**—securely anchors power line cord to chassis—preventing short circuits.
5. **TUBES SUPPLIED**—one each 12SA7 - 12SK7 - 12SQ7 and 50L6 or 14A7 - 14Q7 - 14B6 and 50A5.

**ORDER YOUR BELLTONE
SUPER-HET CHASSIS KIT--TODAY
SHIPPED BY RETURN MAIL**

BELLTONE RADIO and TELEVISION CORP.
583 Ave. of the Americas, New York 11, N. Y.

Yes, I want BELLTONE chassis kits. Enclosed find

money order check for \$.....

SHIP TO

STREET.....CITY.....STATE.....

WANTED! Chief Engineers,

Studio Engineers, Transmitter Engineers for
700 FM Broadcast Stations

the F.C.C. predicts will be in operation by the end of 1947

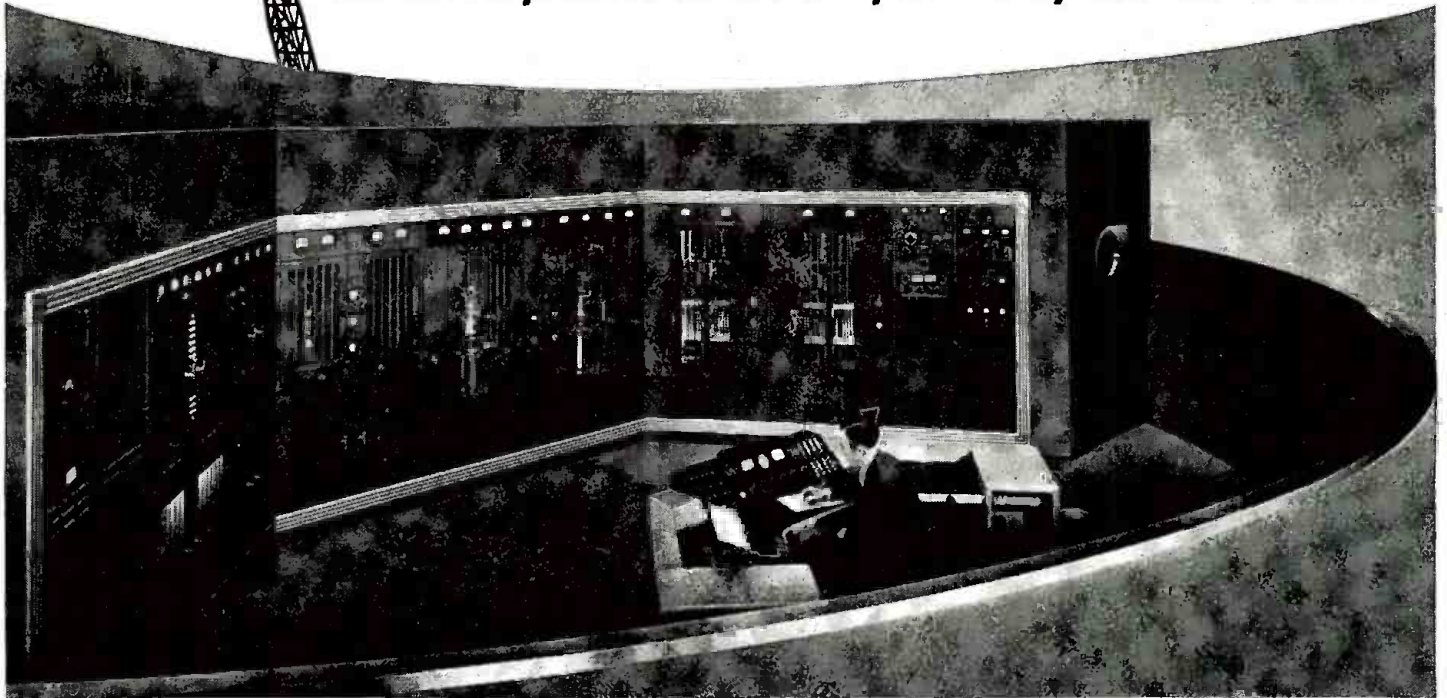

YES, Plenty of Good-Paying Jobs . . . But Only for Those Qualified

FM is actually coming into its own this year . . . 700 new stations, says the F.C.C. Standard broadcast stations have already passed the 1200 mark. By next year there will be 3 times as many broadcasting stations (AM, FM and TV), as there were before the war. Television receivers are rolling off production lines.

Radio is not only expanding in job opportunities but it is also growing in technical complexity. Rapid developments in the field of radio-electronics are leaving many old-time radiomen far behind the parade. These are the men who fail to realize that their technical knowledge must grow with the expansion of radio itself.

What does this mean to *you*? It means you must study not only to hold the job which you now occupy . . . but study to qualify for the better job you want. CREI modern technical training can (within a comparatively short time) qualify you for the better jobs and enable you to step ahead of those who have failed to improve their ability through technical training.

Beginning *right now* CREI can provide the on-the-job program that equips you with the ability to go after—and GET—these important high salaried jobs. Get all the facts today about the unprecedented opportunities that await you. Learn how CREI spare time technical training can help you as it has helped thousands of other professional radiomen advance to better jobs during the past twenty years.

VETERANS! CREI TRAINING AVAILABLE UNDER THE "G. I. BILL!"

CAPITOL RADIO ENGINEERING INSTITUTE

An Accredited Technical Institute

DEPT RC-6, 16TH AND PARK ROAD, N. W. WASHINGTON 10, D. C.

Branch Offices: New York (7), 170 Broadway • San Francisco (2), 760 Market St.

If you have had professional or amateur radio experience and want to make more money, let us prove to you we can give you the training you need to qualify for a radio job. To help us intelligently answer your inquiry — PLEASE STATE BRIEFLY YOUR BACKGROUND OF EXPERIENCE, EDUCATION AND PRESENT POSITION.

MAIL COUPON TODAY FOR THIS 24 PAGE FREE BOOKLET!



CAPITOL RADIO ENGINEERING INSTITUTE

16th & Park Rd., N. W., Dept. RC-6, Washington 10, D.C.

Gentlemen: Please send me your free booklet, "CREI Training for Your Better Job in RADIO-ELECTRONICS", together with full details of your home study training. I am attaching a brief resume of my experience, education and present position.

CHECK PRACTICAL RADIO ENGINEERING COURSE PRACTICAL TELEVISION ENGINEERING

NAME.....

STREET.....

CITY.....ZONE.....STATE.....

I am entitled to training under the G.I. Bill.

LOOK AT THESE VALUES!

ALMO VALUE No. 1

5 TUBE SET

AC-DC, 110 VOLT

AVC Built-in tuned loop. Vernier tuning (size 8x5x6). Walnut or white plastic.



Your Cost **\$15.75**
3 Lot Price **\$15.45**

ALMO VALUE No. 2

AUTOMATIC RADIO PHONOGRAPH COMBINATION



Smart modern walnut design cabinet. Plays 10-10" or 8-12" records. Balanced tone arm. 5 tube superheterodyne with self contained antenna. 110V.-A.C. D.C. operation.

Your Cost **\$50.95**
3 Lot Price **\$49.50**

ALMO VALUE No. 3

Portable PRONO-RADIO

In Beautiful Leatherette Case



A combination radio-record player for all occasions. Radio is 5 tube superheterodyne with built-in loop. Controlled reproduction of both radio and phonograph. Permeability tuned detector, oscillator and IF, for 110V.-A.C., D.C. operation.

Your Cost **\$33.50**
3 Lot Price **\$31.95**



509 ARCH STREET
PHILADELPHIA, PA.
Export Orders Filled Promptly
Cable ALRAD

TRY THIS ONE

COIL WINDING KINK

Recently I had my hand drill clamped horizontally in a vise, trying to rewind a transformer secondary with No. 42 wire. I tried using the table as a support for my hand while guiding the wire by letting it slide between my thumb and index finger. I found that by placing the thumb, holding the wire, on the edge of the table and the index finger under the table, I could move very slowly along the table and wind a closely-wound coil in very little time. It is best to leave at least four inches between the table edge and the winding.

I used a thin sheet of paper between each layer and held it in place with a small piece of Scotch tape.

RAY KIEFER,
Indianapolis, Ind.

VOLTAGE INDICATORS

In the radio shack or service shop, it is often desirable to know the line voltage within limits. For this purpose, I use a pair of neon lamps connected as shown. Quarter-watt neon lamps are available to fit standard pilot light assemblies and they present a neat appearance on the panel.

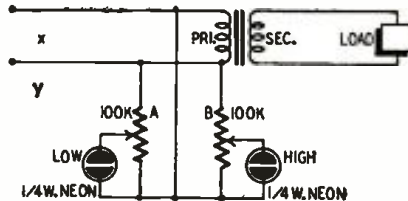

Two 100,000-ohm wire-wound potentiometers are connected in parallel across the a.c. line. The lamps are connected between the arm and one end of the potentiometer. If it is desirable to establish limits between 100 and 120 volts (for example); the potentiometer A is adjusted so that its neon lamp starts to glow when 100 volts is applied across X and Y. Potentiometer B is adjusted so that its lamp glows with 120 volts on X and Y. An autotransformer is useful in making these adjustments.

When the LOW indicator glows it indicates a voltage of 100 volts or more. When the HIGH indicator glows it indicates that the upper limit has been exceeded.

STANLEY E. WEBER,
Arcanum, Ohio

CHANGER SUPPORTS

Record changers are difficult to repair unless supported so that the underside can be reached with ease. To solve this problem, I obtained some lengths of sash chain and four hooks, normally used to attach the sash, and a screen door spring. The spring is cut into four 3-inch lengths and loops formed in each end.

Each spring is fitted with a hook on one end and a chain on the other. The free ends of the chains are fastened to the ceiling, over the workbench, on the

corners of a square about the size of the popular changer bases. Of course, the lengths of chain are adjusted to support the changer level at a convenient height above the workbench. When in use, the hooks are slipped into the mounting holes of the changer base. The chains may be rolled up or pulled to one side when not in use.

ROBERT M. BOSCH,
Philadelphia, Pa.

POWER SUPPLY SAVER

Whenever I construct a power supply for receiver or amplifier, I insert a No. 47 pilot lamp between the negative side of each filter condenser and ground. When cold, the resistance of the bulb is negligible. If one of the condensers shorts, the resistance of the bulb will raise high enough so that the rectifier tube will not be ruined. The shorted condenser can be located merely by locating the condenser connected to the lamp that is lighted. EHRICK H. WRIGHT,
Summit, N. J.

SPOTTING MOUNTING HOLES

It is often difficult to locate accurately mounting holes on a chassis for radio components, particularly large transformers, chokes and variable condensers. This can be done quickly and simply by placing chalk dust in the screw holes, or on the mounting lugs, and placing the component gently in place. A sharp tap on the upper surface will leave clear impressions on the chassis and it is then a simple matter to drill the holes accurately.

G. F. STONEMAN,
Chilliwack, B.C.

BUZZERATOR

Here is the circuit of a little device that I use instead of a signal generator for simple servicing and signal tracing. It consists of a small buzzer, 3-volt battery, volume control, and blocking condenser mounted in a coil shield. I find the unit useful for point-to-point tracing. The blocking condenser makes it possible to apply the test prod to any part of a circuit without danger of shorting.

LEON G. BROWN,
Benton Harbor, Mich.

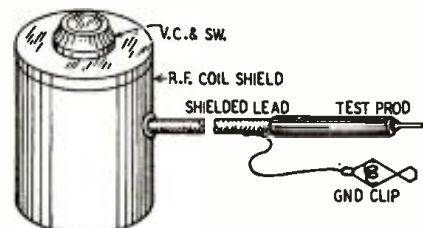
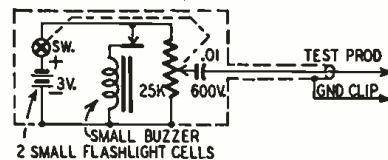

• COMMERCIAL AIR LINES • AIR CHARTER PLANES • YACHTS
 • HOME RADIOS • FISHING VESSELS • AIR FREIGHT • HAM OPERATORS

Brand New Automatic Direction Finder RADIO COMPASS SCR-269-F

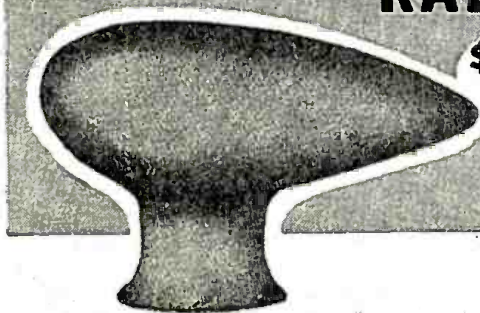

\$75.00 COMPLETE WITH COMPONENT PARTS

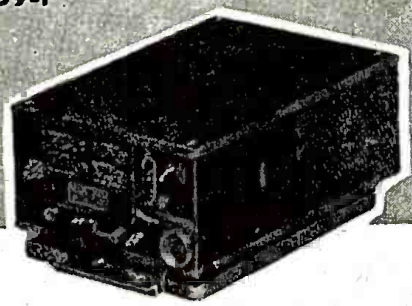

The radio compass SCR-269-F was designed to be the primary radio navigation compass for the United States Army and Navy Air Forces. Constant reception is possible day or night so that fixes can always be made to establish the plane's or ship's location.

The azimuth Indicator is divided into 360 degrees and is connected to the loop antenna, therefore making it possible to navigate the ship in any direction as preset on the dial.

Plotting fixes is accomplished by selecting two or more stations and plotting these on the navigation map. The point of intersection of these lines indicates the location of the craft.

This equipment comes complete with 17 tubes superheterodyne receiver which is tunable from 200-1750 KC in three bands. A complete instruction book for operation and maintenance accompanies this equipment.

COMPONENT PARTS

Quantity	S. C. Stock No.
1	Radio Compass Receiver BC-433-F.....2C3016 F.1
1	Radio Control Box BC-434-F.....2C3324 F.1
1	Mounting FT-213-A.....2Z6721-213A
1	Mounting FT-224-F.....2Z6721-224F
1	Loop LP-21-F (Includes Dehydrator).2Z1921 F.1
1	Cord CD-365-A.....3E1365
1	Indicator I-81-F.....2Z5381F
1	Relay SW-172.....2Z7672F

Quantity	S. C. Stock No.
1	Plug PL-112.....2Z7212
1	Plug PL-118.....2Z7218
1	Plug PL-122.....2Z7222
1	Dehydrator Hose, Fitting & Clamps
1	10 foot lengths.....2Z8727
1	Operating & Maintenance Handbook
1	Coupling MC-136.....2Z3266
1	Tuning Shaft MC-124 (300").....2ZA124-300

Quantity	S. C. Stock No.
1	Insulator IN-79.....3G579
1	Insulator IN-81.....3G581
1	Shaft Casing and Spline Drive.....2ZA124/1&4
1	Shafting F/MC-124 (300").....2ZA124/1
5	Nut F/MC-124.....2ZA124/2
5	Spline F/MC-124.....2ZA124/4
5	Sleeve F/MC-124.....2ZA124/3
1	Transformer C289AS-R16-T

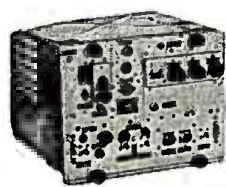

TRANSMITTER & RECEIVER
\$14.95

The famous boat anchor, widely used on 144 MC band. Shipping weight 100 lbs. Your price, less tubes and power transformer.....\$14.95

MODULATION TRANSFORMER 1KW

\$14.95

RCA modulation transformer is conservatively rated at 550 Watt audio to modulate that new KW rig. Really rugged construction with protective flashover gaps, which are adjustable. Terminals and gaps are mounted on a "Mycalox" terminal board. The laminations that make up this transformer are of high audio quality and are extremely thin, making it impossible for the core to "chatter or talk".
 Audio Watts—550 Sec. #1-450 Mils Sec. #2-80 Mils Turns
 Ratio—Pri: Sec. #1-1:1 Pri: Sec. #2-5:1 Pri: Sec. #2 Top-25:1
 Impedance Ratio—Pri: #1-1:1 Sec. Pri: Sec. #2-25:1 Pri: Sec. #2 Tap-625:1
 DC Resistance—Pri: 135 ohms Sec. #1, 112 ohms; Sec. #2, 99 ohms.
 Transformers insulation tested: Pri. 8000V.; Sec. #2-2000V. to the rest of the coils and core. Primary center tapped for Class "B" modulators. Secondary #2 will carry 80 Mils to modulate screens of beam power or screen grid tubes. Primary will match any Class "B" tubes up to 10,000 ohms plate to plate, such as 810's, 751's, 8005's, ZB120's, 203's, HY512's, 211's, 813's, 828's, 805's, 2037's.
 Size 9 1/2" wide, 7 1/2" deep, 7 1/4" high. Heavy channel iron mounting brackets. Weight approx. 40 lbs.

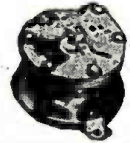
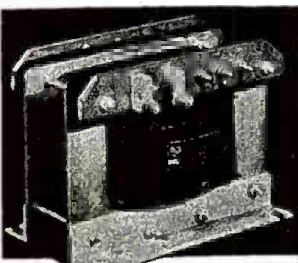

BUTTERFLY CONDENSERS

Type B—frequency range 300 to 1000 megacycles
 Cat. No. BC-2

Power Transformer
 Pri: 115V 60Cy.
 Sec. 1—255/255 80MA
 Sec. 2—6.3V 3.8A
 Sec. 3—.5V 4A

BC 191 TRANSMITTER

Less tubes and tuning units, **\$14.95**

SCR 625 MINE DETECTOR

\$49.50

BC 654 TRANS. & REC.

Used with tubes **\$14.95**

MICA CAPACITOR

.002 MFD 3000V VDC. Cat. No. 49c
 RT-101

IF TRANSFORMER

Mounted in aluminum shield can 1500 Kc. with air trimmer. Impedance coupled type. Cat. No. T-19..... **95c**

30MC IF TRANSFORMER

In square aluminum can, silver slug tuned. Cat. No. T-20..... **29c**



TUNING UNIT

Turning Unit BC 375. Approx. 65 M.A.F.D. cond., coils, RF chokes dials, assist'd mica condensers 2500 WVDC. over \$50.00 in parts. Cat. No. TU-101..... **\$37.50**



NEW BC 223 AX TRANSMITTER

801 Oscillator and 801 Power Amplifiers, 2-46 Modulators and 1-46 Speech Amplifier 4 Xtal Frequencies and Master Oscillator on selector switch. 10 to 30 watts output, Tone Voice or C.W. Mod. Ideal for 80 meter band. Comes with 3 coils TU 17A 2000-3000 Kc. TU 18 3000-4500 Kc. TU 25 3500-5250 Kc. Black wrinkle case. Includes 2 separate cases to store extra coils. Frequencies chart and tubes included, packed in original cases, less crystals at this low price. Cat. No. MT-100..... **\$29.95**

BC375E Gen. Elect. Mopa Trans. complete with tubes, 7 tuning units, Dynamotor and Antenna Tuning Unit Brand New in original crates..... **\$49.95**

FILAMENT TRANSFORMERS

Thordarson 6.3 V-4 amps, 6.3 V-4.5 amps, 9.7 V-5 amp, pri. 110 V AC 25 or 60 cy.—Cat. No. FT-11.....	1.95
Thordarson pri. 110 V 60 cy.—sec. 6.3 V 6 A, CT—Cat. No. FT-12.....	1.49
Thordarson 8 HY 150M choke, Cat. No. FC-201.....	.95
Thordarson 12 HY 25M choke, Cat. No. FC-203.....	.39

CONDENSERS

Cat. No.	Cap. MFD.	Working Volts	Your Cost
C110.....	1.....	5000 Oil.....	\$3.95
C111.....	3.....	4000 Oil.....	4.95
C112.....	1.....	1000 Oil.....	.44
C114.....	8.....	600 Oil.....	.95
C115.....	2.....	600 Oil.....	.49
Westinghouse 1 MFD 6000 volts WVDC.....			\$7.95
Westinghouse 2 MFD 6000 volts WVDC.....			10.95
Westinghouse 1 MFD 10,000 volts WVDC.....			12.95

TUBES

813.....	\$ 5.45	829.....	\$ 2.45
814.....	4.95	872A.....	1.95
RK60.....	1.25	211.....	1.45
VT127.....	2.95	VR150.....	.69

Write for FREE Bulletin



Hershel RADIO COMPANY

5249 GRAND RIVER • DETROIT 8, MICH.

20% Deposit Required on All C.O.D. Orders. F.O.B. Detroit. \$2.00 Minimum. Michigan sales add 3% Sales Tax

SILVER

EXPERTS CHOOSE



"VOMAX" is the overwhelming choice of experts because it's the finest, perfected v.t.v.m. . . . because greatest demand makes greatest production and lowest cost to you.

"VOMAX" gives you a total of 51 ranges to directly measure d.c., a.c., a.f., i.f. and r.f. volts up through hundreds of megacycles, six resistance ranges covering 2 10ths ohms through 2,000 meg-ohms, three output meter-decibel ranges from -10 through +50 db., six direct current ranges measuring from 50 microamperes through 12 amperes. Most important is the absolute stability, complete freedom from usual gnd current errors . . . and its astronomical input resistance . . . or honest 0.6 megohms upon a.c., a.f., i.f. and r.f.; 51 and 126 megohms upon d.c. Voltage ranges measure from .1 through 3000 volts d.c., .1 through 1200 volts a.c.

If you want to guard your meter dollar investment . . . to make it only once for many years to come . . . then "VOMAX" at its present low \$59.85 net price is your logical choice . . . as thousands more wise technicians like yourself have proved to their profit.

Let's look at this matter of what meter you buy seriously . . . for your choice of this, the service technicians basic instrument, can spell either peace and profit . . . or annoyance and loss to you. You must have the best meter to meet "smart" competition. And "smart" competition overwhelmingly uses "VOMAX." The reason is simple. Other manufacturers have had to copy "VOMAX" inventions to try to satisfy your demand for a modern, post-war, obsolescence-proof universal meter. Yet, "VOMAX," the perfected v.t.v.m., stands head and shoulders above all other meters. This is proved by its heavy purchase and use by the Bureau of Standards in Washington, by Western Electric, G. E., Westinghouse, university after university, by top-ranking industrial laboratories, F.C.C., C.A.A., Veterans Administrations, schools, colleges . . .

NEW IMPROVED "SPARX"



Thousands of technicians today rely on "SPARX" dynamic signal tracer to save time . . . increase efficiency . . . cut their costs. It lets you hear and see signals . . . traces signal right on thru every receiver circuit from antenna thru voice-coil . . . is shop test speaker, too. Continuous laboratory research has now improved "SPARX" immensely . . . created the Improved Model . . . tremendously increased sensitivity . . . greatly expanded general usefulness. And the SILVER policy of protecting your dollar investment pays out handsomely . . . a free bulletin tells every user how to convert his "SPARX" into the new, Improved Model in a jiffy . . . goes to prove that for the really serious, profit-conscious technician there's no substitute for SILVER, that "SPARX" costing you only \$39.90 is outstandingly the world's best signal tracer. "SPARX" will earn you, too, more profits in less time than any other instrument you can buy.

906

Thanks for your patience. Model 906 Signal Generator is now flowing to your favorite jobber. And what an instrument . . . 90 kc. through 170 mc. on fundamentals . . . 8 air-trimmed bands . . . variable % 400 ~ amplitude modulation . . . built-in variable electronic FM sweep . . . laboratory triply adjustable attenuator . . . metered microvolts . . . output 1/2 microvolt to over 1 volt . . . multiply shielded stroy's lower than \$500.00 laboratory generators! Yet all this costs you only \$89.90 net. Better order your 906 now for demand far exceeds production capacity on this precision instrument for months to come.

Send Post Card for Catalog of new measuring equipment, communication receivers, transmitters, kits, parts. See them at your favorite Jobber.

OVER 36 YEARS OF RADIO ENGINEERING ACHIEVEMENT

McMurdo Silver Co., Inc.

1249 MAIN ST., HARTFORD 3, CONNECTICUT

TECHNOTES

PHILCO 37-600

The resistance of the primary of the oscillator coil, normally 2.4 ohms, rises to a very high value—in the order of 50,000 ohms in one case. This coil is difficult to replace or rewind. I was able to obtain an old coil wound with the same size wire on a form that would permit it to slip over the damaged primary winding. Wire was removed from the replacement until its resistance was 2.4 ohms. The old leads were clipped and new ones soldered in place. The set was aligned and worked like new.

LOUIS HOLST,
San Antonio, Texas

HUM REDUCTION

Experience has taught me never to mount a flat type power transformer directly on a chassis made of magnetic material if any type of high-gain amplifier is mounted on the same chassis. Eddy currents will be set up in the chassis and disturb the grid returns. The transformer should be insulated from the chassis with nonmagnetic spacers or washers. Brass spacers will work well.

ALFRED J. ELBOZ,
Sydney, Australia

RADIOS WITH LOCTAL TUBES

When working with sets with loctal tubes, you may find that tapping or moving the tubes in their sockets will cause intermittents or noise. In many cases the trouble can be traced to tube pins which have become oxidized or bent. Buff each pin until bright and then bend each one slightly outward. Extreme care should be used in bending the pins to prevent breaking the glass. After you have done this, reinstall the tube and allow it to warm up. Tap it. If the noise is gone the trouble is cured.

JOHN MEDNANSKY,
Belle Fourche, S. D.

HALLICRAFTERS SX-28A

Complaint: Slight heating of the power transformer, "S" meter hits the pin. Adjusting the meter potentiometer has little effect.

The meter adjustment control is mounted directly on the metal chassis with its center terminal insulated from the metal case. This meter is in the plate circuit and the insulation of the control breaks down, putting an extra load on the power supply and drawing full current through the meter. As a cure, I enlarged the potentiometer mounting hole and reinstalled the control after insulating its shaft with a bakelite insulating washer.

JAMES C. MCGUIRE,
Los Angeles, Calif.

SILVERTONE 6336

Intermittents in this set are often caused by a defective oscillator grid condenser. This unit changes its value intermittently. Replacing it with a high-quality 50- μ f condenser will clear up the trouble.

MCCLESKY RADIO CO.,
Baton Rouge, La.

**GENERAL ELECTRIC
150 WATT
TRANSMITTER**

**Cost the Government \$1800.00
Now only \$44.50!**

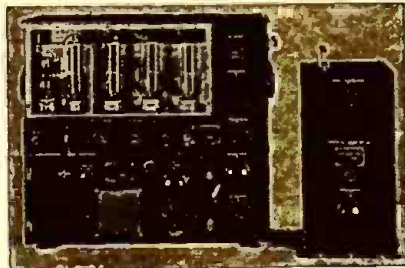

This is the famous transmitter used in U.S. Army bombers and ground stations, during the war. Its design and construction have been proved in service, under all kinds of conditions, all over the world. The entire frequency range is covered by means of plug-in tuning units which are included. Each tuning unit has its own oscillator and power amplifier coils and condensers, and antenna tuning circuits—all designed to operate at top efficiency within its particular frequency range. Transmitter and accessories are finished in black crackle, and the milliammeter, voltmeter, and RF ammeter are mounted on the front panel. Here are the specifications: **FREQUENCY RANGE:** 200 to 500 KC and 1500 to 12,500 KC. (Will operate on 10 and 20 meter band with slight modification). **OSCILLATOR:** Self-excited, thermo compensated, and hand calibrated. **POWER AMPLIFIER:** Neutralized class "C" stage, using 211 tube, and equipped with antenna coupling circuit which matches practically any length antenna. **MODULATOR:** Class "B"—uses two 211 tubes. **POWER SUPPLY:** Supplied complete with dynamotor which furnishes 1000V at 350 MA. Complete instructions are furnished to operate set from 110V AC. **SIZE:** 21 1/2 x 23 x 9 1/2 inches. Total shipping weight 200 lbs., complete with all tubes, dynamotor power supply, tuning units, antenna tuning unit and the essential plugs. These transmitters are priced to move fast: Order today and be the proud owner of one of the finest rigs obtainable.

BENDIX SCR 522—Very High Frequency Voice Transmitter-Receiver—100 to 156 MC. This job was good enough for the Joint Command to make it standard equipment in everything that flew, even though each set cost the Gov't. \$2500.00. Crystal Controlled and Amplitude Modulated—**HIGH TRANSMITTER OUTPUT** and 3 Microvolt Receiver Sensitivity gave good communication up to 180 miles at high altitudes. Receiver has ten tubes and transmitter has seven tubes, including two 832's. Furnished complete with 17 tubes, remote control unit control unit, dynamotor and Ant. \$37.95.

We include free parts for the conversion to continuously variable frequency coverage in the receiver, as well as circuit diagrams for operations of the unit on 110V A.C.

SCR-274 N COMMAND SETS. Including 3 separate 8 tube superhet receivers. 2 separate transmitters, each with 40 watts output, modulate and DC power supply. Bargain price for all 6 pieces complete with tubes.....\$29.95

AIR CRAFT MARKER BEACON—Complete with 3 tubes and sensitive relay to control external circuits from received signals. Just the receiver you have been waiting for to control models, open doors from a distance, etc. Priced at only.....\$4.95

AIRPLANE AMPLIFIER C-1 contains 3-7N7, 3-7E7, and 1-7Y4. In aluminum case 9x8x7.....\$9.95

BC-654 TRANSMITTER RECEIVER—Complete with 17 tubes and 200 Kc. calibrating crystal.....\$39.95

5" Receiver Indicator Oscilloscope with 31 Tubes

This unit, sold by Western Electric for \$2500.00, includes a 13 tube receiver with 7 IF stages; 2 tube multivibrator sweep generator; 2 tube sweep amplifier; video amplifier; pedestal impulse and sweep generator; and 115 V, 60 cycle supply with 2X2 for high voltage. Makes a wonderful laboratory instrument, or can be more easily converted to a complete home television receiver than any other war surplus item. Only \$69.95

13 Tube BC412 Radar Oscilloscope—Easily converted to a superb laboratory oscilloscope by just a little work. Already 110V, 60 cycle.....\$59.95

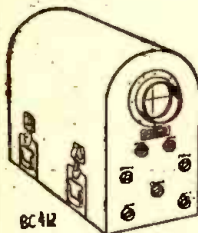

BC-947A ONE KILOWATT HIGH FREQUENCY TRANSMITTER—This relay-controlled transmitter includes a 115 V., 60 cycle power supply, protected by 3 magnetic circuit breakers, that alone is worth more than the price we are asking for the whole rig, even on today's surplus market. On the front panel are six 3 1/2" GE or Weston meters, including 250 MA, 50 MA, 1000 MA, 150 V. A.C., and 1500 V. D. C. at 1000 ohms per volt for screens and plate. The Rack-type 21"x16"x36" unit contains 6 amplifier and rectifier tubes aggregating over \$60.00 at WAA current wholesale prices; Western Electric's price to the government was \$1500.00. Shipping weight 500 lbs. Your cost, as is, only.....\$69.95

BC 221 FREQUENCY METERS with calibrating Crystal and calibration charts—A precision frequency standard that is useful for innumerable applications for laboratory technician, service man, amateur, and experimenter, at the give away price of only \$39.95

5BP4 CATHODE RAY TUBE, 5" tube at the lowest price ever offered.....\$3.95

**GENERAL ELECTRIC RT-1248 15-TUBE
TRANSMITTER-RECEIVER**

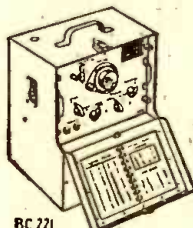

TERRIFIC POWER—(20 watts) on any two instantly selected, easily pre-adjusted frequencies from 435 to 500 Mc. Transmitter uses 5 tubes including a Western Electric 316 A as final. Receiver uses 10 tubes including 955's, as first detector and oscillator, and 3-7H7's as IF's, with 4 slug-tuned 40 Mc. IF transformers, plus a 7H7, 7E6's and 7F7's. In addition unit contains 8 relays designed to operate any sort of external equipment when actuated by a received signal from a similar set elsewhere. Originally designed for 12 volt operation, power supply is not included, as it is a cinch for any amateur to connect this unit for 110V AC, using any supply capable of 400V DC at 135 MA. The ideal unit for use in mobile or stationary service in the Citizen's Radio Telephone Band where no license is necessary. Instructions and diagrams supplied for running the RT-1248 transmitter or receiver, as an amateur television transmitter or receiver, for remote control relay hook-ups, for Geiger-Mueller counter applications, and it sells for only \$29.95. 10% less if ordered in lots of 2 or more. If desired for marine or mobile use, the dynamotor which will work on either 12' or 24V DC and supply all power for the set, is only \$15.00 additional.

SERVICEMEN

Check This Column for Lowest Prices on Quality Parts

Tubes: A warehouse full, including the new miniatures. Order all the types you need and we will try to supply you completely. The following prices are for fifty or more tubes assorted 5% less on lots of 100 or more. 27, 53Z, 80, 38E, 28, 35Z5, 56, 75, 44, 70, 73, 615, 52C, 6SK7, 6SQ7, 12SA7, 12SQ7, 5U4, 6CG, 6DB, 6SA7, 54c, 6SJ7, 12SJ7, 5Y4, 5Z3, 6K6, 6K7, 6V6, 6SD7, 60c, 6J7, 6K8, 6SF7, 72c, 5V4, 6R7, 12BA6, 12AT6, 88c, 6L6, 99c, 32L7, \$1.08; 50B5, \$1.28. These special prices on tubes are for one month only.

POWER TRANSFORMERS—Half-shell type, 110V, 60 cy. Centertapped HV winding. Specify either 2.5 or 6.3V filament when ordering.

For 4-5 tube sets—650V, 40MA, 5V & 2.5 or 6.3V.....\$1.49
For 5-6 tube sets—650V, 45MA, 5V & 2.5 or 6.3V.....1.75
For 6-7 tube sets—675V, 50MA, 5V & 2.5 or 6.3V.....1.90
For 7-8 tube sets—700V, 70MA, 5V & 6.3 or two 2.5V.....2.35
For 9-11 tube sets—700V, 100MA, 5V & 6.3 or two 2.5V.....2.85
For 9-15 tube sets—600V, 150MA, 5V & 6.3V.....2.95

TRANSFORMERS—All types in stock. **AUTO-TRANSFORMERS:** Steps up 110v to 220v or steps down 220v to 110v—\$1.95. **FILE TRANS:** 6.3v, 8 Amps—\$1.98; 5v, 10 Amps—\$1.98; Universal Output Trans. 8 Watt—89c; 18 Watt—\$1.29; 30 Watt \$1.69. **AUDIO TRANSFORMERS:** S. Plate to S. Grid. 3:1—79c; S. Plate to P.L. Grids—79c; Heavy Duty Class AB or B. P.P. inputs—\$1.49; Midget Output for AC-DC sets—69c; **MIKE TRANSFORMER** for T-17 Shure microphone, similar to UTC ounce type—\$2.00.

CONDENSERS—PAPER TUBULAR 600 WV—001, 002, 005—8c; 01, .05—9c; 1—10c; 25—23c; .5—36c; **ELECTROLYTICS:** 8mfd 200v—29c; 10mfd 35v—20c; 20mfd 150v—23c; 20/20mfd 150v—35c; 30/20 150v—46c; 50mfd 150v—43c; 8mfd 475v—34c; 10mfd 350v—65c; 0.....**CONDENSERS:** 4mfd 600v 49c; **BATH TUB TYPE CONDENSERS:** 3X.1mfd—20c; **RESISTORS:** All types in stock at the lowest prices; Resistor Kits; 160 2 watt resistors—\$1.95.

FILTER CHOKES: 200, 300, 400, 500 ohm light duty—59c; 200 or 300 ohm heavy duty—99c; 250 ma 35 ohm made for U.S. Navy, fully shielded—\$1.95; 75 ohm 125 ma—25c or 25 for \$4.25; "Melsner type" tapped filter chokes—25c; 8 amp. iron core A filter—25c; Choke-condenser combination, ideal to replace any size speaker field when installing 1M speakers—79c. **110 V. CIRCUIT BREAKERS** of Magnetic type: Following Current Ratings in Stock; 1.25, 3, 4, 8 Amps. Please specify. \$1.95.

SEVEN ASSORTED I.F. TRANSFORMERS—\$1.98; Five Ass't. Oscillator Coils—60c.

WILLARD rechargeable 2 volt storage batteries for G.E. portable radios \$2.95.

SPEAKERS—PM dynamic type—4"—\$1.55; 5" \$1.55; 6" \$1.95; 8" \$3.95; 10" \$5.95; 12" \$7.50.

PHONO AMPLIFIERS—A real AC, 110V, 60 Cycle, 6 Watt Amplifier suitable for PA systems and phonograph; with a husky power transformer. Complete with tubes—\$12.95.

PUBLIC ADDRESS AMPLIFIERS—25 Watts peak output, 5 tubes, separate controls for Microphone and Phono Inputs. \$65.00 value for only \$32.00.

Crystal pick-up, phono motor and turntable—\$5.25.

LINE FILTERS—110V—each unit contains two 2 mfd. oil filled condensers and a 15 amp. iron core choke. This filter has innumerable uses such as oil burner line filter, etc. A ten dollar value for \$8.

HEADPHONES—Highest quality Signal Corps headsets with sponge rubber ear cushions. 12' cord and plug \$1.00. 5' rubber covered patchcords with phone plug and socket—25c.

RELAYS—Guardian SPST 12-24v. has heavy duty 15 Amp. Contacts—\$1.25; Guardian 12 to 24v D.C. triple make, single break relay, 5 for \$3.75; Sigma super-sensitive 2000 ohm D.C. SPDT Relay. (May be adjusted to operate on less than 1 Milliampere)—\$2.50.

6 POLE DOUBLE THROW, Telephone Type 2000 ohm Relays, Super Sensitive, \$2.50 each, or two for \$4.50.

SELENIUM RECTIFIERS—Dry disc type 1 1/2" by 1", 1.2 Amp. maximum, suitable for converting DC relays to AC for supplying filament source in portable radios, converting DC meters to AC applications, and also may be used in low current chargers—90c.

METER RECTIFIERS—Full wave, may be used for replacement or in construction of all types of test equipment—\$1.25. Half Wave—90c.

WIRE—No. 18 POSJ 2 conductor parallel zipcord, brown, 250 ft. spools, \$4.25; 500 ft. spools, \$7.95; No. 18-PO brown rayon covered parallel lampcord, 500 ft. spools, \$7.95; No. 18 SV round rubber covered double wire for wash machines, vacuum cleaners, etc., 250 ft. spools, \$6.95; Rubber covered milk cable, 6c per foot; R8U 50 ohm coax cut to any length, 8c per foot; single stranded conductor shielded lead with brown rubber over shield, super special, \$1.20 per 100 ft., \$10.00 per 1000 ft. All kinds of hook-up wire, 1c per foot.

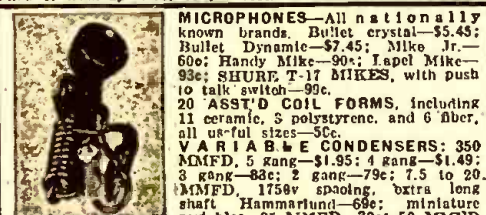

MICROPHONES—All nationally known brands. Bullet crystal—\$5.45; Bullet Dynamic—\$7.45; Mike Jr.—60c; Handy Mike—90c; Topol Mike—93c; **SHURE T-17 MIKES,** with push to talk switch—99c. **20 ASS'D COIL FORMS,** including 11 ceramic, 3 polystyrene, and 6 fiber, all useful sizes—30c. **VARIABLE CONDENSERS:** 350 MMFD, 5 gang—\$1.95; 4 gang—\$1.49; 3 gang—88c; 2 gang—79c; 7.5 to 20 MMFD, 1750v spacing, extra long shaft Hammarlund—68c; miniature variables, 25 MMFD—39c; 50 MMFD—49c; 75 MMFD—55c; 100 MMFD—69c; 140 MMFD—79c. **TRANSMITTING RF CHOKES,** 4 PIE, 850 Ma.—25c or 4 for \$1.00. **INTERRUPTION FREQUENCY COILS** for super-regenerative receivers or the tremendously popular FM adapters for standard broadcast sets. Iron core with a resonant frequency of 50 KC—39c; Air Core, 100 KC—29c. **30 MC IF TRANSFORMERS,** double slug tuned—25c. **VIDEO AMPLIFIER PLATE COILS—**Slug tuned—25c. **REMOTE CONTROL UNIT:** Aluminum case 4x3x2" containing 2 potentiometers, triple pole switch, 4 knobs, gear mechanism, counter and phone jacks—68c. **MODULATION TRANSFORMERS—**10 watt, metal case 98c; 30 watt, open-type, \$1.95; 40 watt, cast aluminum case, \$2.95; Class "B" input transformers, cast aluminum case, \$1.95; Transceiver audio transformers, 65c; Transceiver modulation transformers, 65c. **150 Volt AC meters,** 2 1/2" diameter—\$2.49.

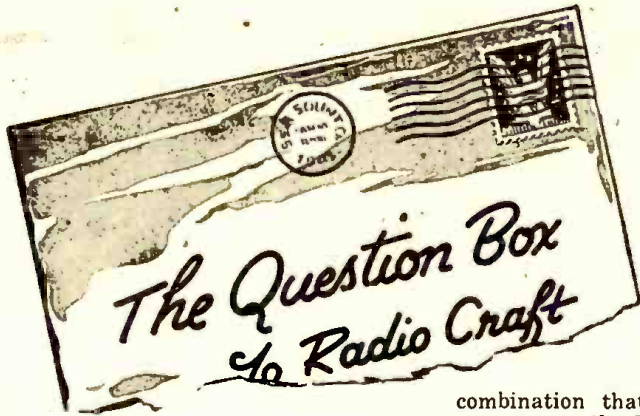

Question Box queries will be answered by mail and those of general interest will be printed in the magazine. A fee of 50c will be charged for simple questions requiring no schematics. Write for estimate on questions that may require diagrams or considerable research.

QUESTION BASS-REFLEX ENCLOSURE

I would like to have plans for constructing a bass-reflex enclosure for a 15-inch speaker.—C.O.R., Kansas City, Kansas.

A. A bass-reflex enclosure design is shown in the figure.

The hair felt or rock wool pads are placed to absorb the high frequency notes coming from the rear of the

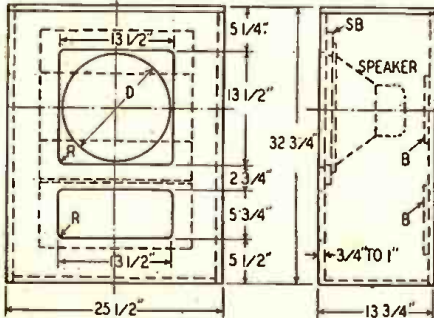

speaker. The exact size and placement of the pads depends upon a number of variables including speaker and wood characteristics. Experimenting with the size and placement of the pads will result in optimum performance.

QUESTION PHONO-RADIO

I would like to have a diagram of an a.c.-d.c. phonograph and radio combination. It should be capable of being built very compactly as I want to mount it in a small portable case.—P.S., Chicago, Ill.

A. Here is a circuit for a phono-radio

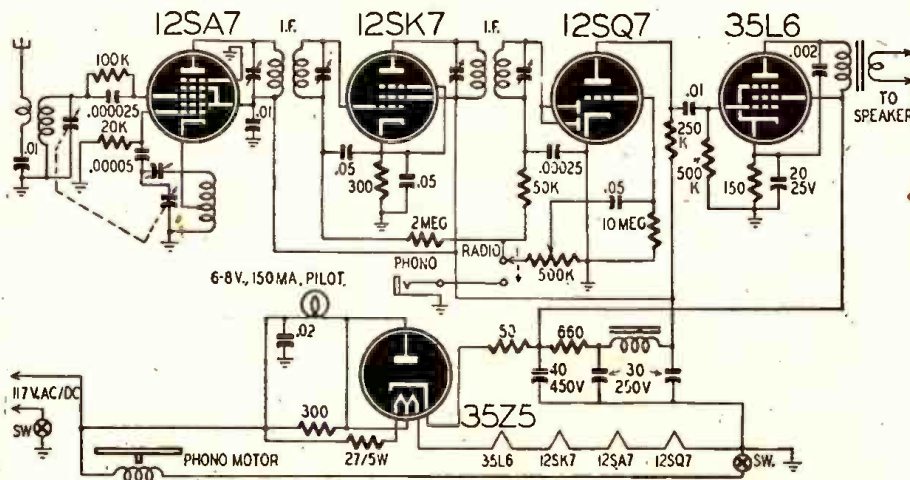

combination that may be constructed very compactly. These tubes may be obtained in the GT/G series. When they are used with midget i.f. transformers, very little space is consumed.

QUESTION FM RECORD PLAYER

Please print a diagram of a frequency-modulated record player to be used in demonstrating FM receivers on the 88 to 108 mc band.—G.V., Spokane, Wash.

A. Here is the circuit of a four-tube FM record player for use on the new bands. It uses a 7A4 speech amplifier followed by a 7Q7 modulator. Another

greatest frequency deviation from the maximum applied audio input.

The r.f. chokes consist of 20 to 25 turns of No. 24 s.c.c. wire wound to an inside diameter of 1/4 inch. Slight variations in each choke are recommended to prevent parasitic oscillations.

QUESTION COIL DATA

I am building a superhet. receiver to cover from 550 kc to 25 mc when using 365- μ f condensers and an intermediate frequency of 465 kc. Please supply me with winding data for antenna, oscillator, and r.f. coils. What size padding condenser should I use?—C.W.W., St. Paul, Minn.

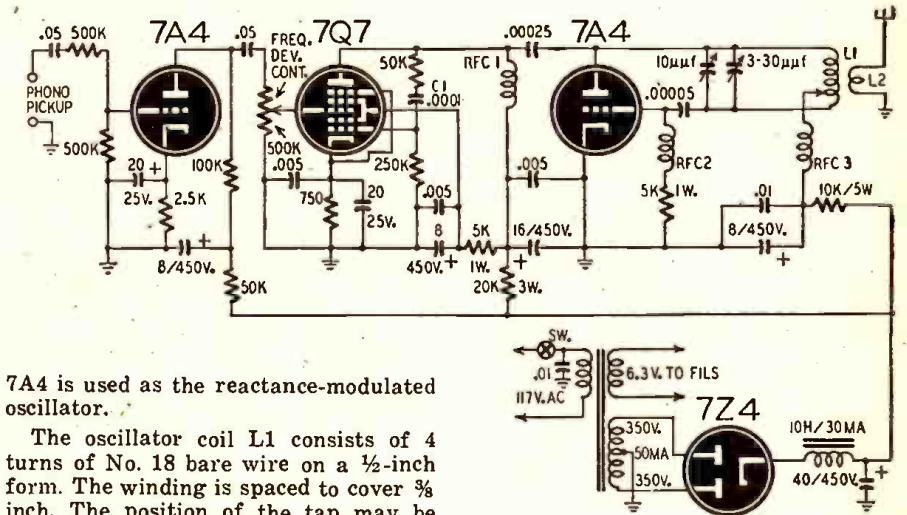

7A4 is used as the reactance-modulated oscillator.

The oscillator coil L1 consists of 4 turns of No. 18 bare wire on a 1/2-inch form. The winding is spaced to cover 3/8 inch. The position of the tap may be located best by experiment. L2 has 2 turns of No. 18 enamelled wire closely coupled to L1.

C1 may be varied to obtain the

A. Here are the coil specifications. All coils are close-wound with enamel wire on 1-inch forms.

Band (Mc)	R.F. Coil		Osc Grid		Osc Plate	
	Turns	Wire Size	Turns	Wire Size	Turns	Wire Size
0.55—1.5	146	32	92	32	20	32
1.50—4.0	36.2	30	30.9	30	12	30
4.0—10.0	10.1	30	9.7	30	12	36
10.0—25.0	4.4	20	4.3	20	6	36

The oscillator coils for the 0.55—1.5— and 1.5—4.0-mc bands are wound with the plate coil over the primary, the B-plus end being toward the primary's grid end. For other bands, the coils are wound side by side with 1/32 inch between them. The grid and plate connections are then made to the ends of the coils with the B-plus and cathode connections at the center. Padding condensers are 400 μ f, 1,070 μ f, 2,900 μ f, and 7,300 μ f, respectively, beginning at the broadcast band.

**V.F.O. EXCITER
OR TRANSMITTER**

(Continued from page 30)

ed excellent. Not until a 0.5- μ f fixed condenser was added across one side of the power line and ground were we able to clear up the signal of the v.f.o. Evidently radiation had been picked up by house wiring and had modulated the oscillator supply.

The frequency of every oscillator depends to some extent upon plate and screen potentials. Turning on a light or electric iron will cause a variation in voltage which in turn will change the oscillator frequency. Even the transmitter itself constitutes a variable load as it is keyed. These voltage changes are made negligible by using the common voltage-regulator tubes. These are widely available as surplus items and are easy to connect into regulating circuits. It is advisable to regulate not only the oscillator potentials but the following buffer as well.

Drift is due to heating of tube elements, components, and wiring. Mica and paper condensers cannot be used in critical circuits. The more expensive ceramic type of condenser has a low temperature coefficient so its capacitance remains constant. In any case the transmitter should be left on for several minutes before calling since there is always an initial drift.

Chirp is the result of a change in frequency while a rig is being keyed. This may be due to a changing load, oscillator blocking, or an unstable oscillator. It is often claimed that the oscillator should be left running at all times for best results. On the other hand, keying the oscillator permits break-in as soon as the key is up. In addition, intermittent oscillation prevents too great a change in temperature between intervals of transmission and reception. With a well-designed high-C oscillator there should be no chirp during keying. On the other hand, it is quite possible that keying the final or a buffer may introduce serious chirp. Unless isolation is complete, keying any stage will vary oscillator loading and frequency. To check for this condition tune the stage through resonance. If there is no noticeable change in frequency, that stage may be keyed.

In checking for chirp, drift or unsteady signals, it is most effective to listen in at some high harmonic of the signal. As mentioned before, any change in frequency is multiplied by the order of harmonic.

In addition to technical problems which accompany a v.f.o., there also seems to be a psychological handicap. Some hams feel that all such rigs are inherently unstable. While an easy-to-read and stable signal always gets a T9X report and little additional comment, it is sometimes true that far more critical listening follows if the signal is known to come from a v.f.o. Actually, of course, even a crystal oscillator is subject to many of the ills of the variable oscillator unless it is correctly designed.

new

CONCORD

Radio

Catalog



**Radio Parts
Radio Sets
Ham Gear
Amplifiers**

free
Radio Hams • Servicemen • Engineers
Sound Men • Maintenance Men
Schools • Institutions • Manufacturers
THIS CATALOG IS FOR YOU!
Mail **COUPON TODAY!**

Industrial Electronic and Test Equipment

It's here—ready for you now—the new, comprehensive, 1947 Concord Catalog displaying a vast, complete selection of everything in Radio and Electronics. Send for your copy now. Select your needs from value-packed pages showing thousands of items available for IMMEDIATE SHIPMENT—hundreds of them now available for the first time—featuring new, latest 1947 prices. See the new LOWER prices on finest-quality RADIO SETS, PHONO-RADIOS, RECORD CHANGERS, RECORD PLAYERS, PORTABLES, AMPLIFIERS, COMPLETE SOUND SYSTEMS, TESTERS. See complete latest listings of all the well-known, standard, dependable lines of radio parts and equipment—tubes, condensers, transformers, relays, resistors, switches, speakers—all available for IMMEDIATE SHIPMENT from huge stocks in CHICAGO and ATLANTA. Whatever your needs in Radio and Electronic Parts, Supplies and Equipment—before you buy—SEE THIS GREAT NEW CONCORD CATALOG. Mail coupon for your FREE copy now.



CONCORD
RADIO CORPORATION
CHICAGO 7 ★ ATLANTA 3
901 W. JACKSON BLVD. 265 PEACHTREE ST.
LAFAYETTE RADIO

Concord Radio Corporation, Dept. RC-67
901 W. Jackson Blvd., Chicago 7, Ill.
Yes, rush FREE COPY of the comprehensive new Concord Radio Catalog.

Name

Address

City State

SCOOP!

BC-654 Transmitter Receiver NET \$12.95



Portable voice and CW transmitter and receiver for portable, mobile, and fixed station operation. 7-tube superheterodyne receiver with 3.5 microvolt sensitivity on voice and 0.5 microvolt sensitivity on CW, and 100 milliwatts undistorted power output. 455 KC IF. Uses 3-1N3GT, 1-1A7GT, 2-3Q5GT, 1-1H5GT tubes. 6-tube transmitter with antenna tuning network. Coplits thermal compensated oscillator, ass. 2 final with 2 307A tubes in parallel, and crystal oscillator for checking frequency every 200 KC. 25 watts output on CW and 11.2 watts output on voice. Frequency range, transmitter and receiver, 3800 to 5800 KC. Ideal for Ham! Comes complete with cover; set of tubes installed, 5 spare tubes and 3 spare pilot lights. Less power supplies. These units are in good condition. Shipping weight 50 lbs. Net price with all tubes and spares \$12.95. The 654 unit, only, shipped from our Chicago warehouse. Send your order to Kansas City.

BC-645 I.F.F. \$14.95



ARMY BC-645 I.F.F. UNIT. Net \$14.95. Early in the war, when radar picked up a plane, there was no way of knowing whether it was friendly or not. That was before BC-645 was invented. BC-645 sent out a signal that identified the plane as American. It probably saved more lives than any other piece of electronic equipment made. With some modifications the set can be used for 2-way communication, voice or code, on the following bands: ham band 420-450 mc., citizens radio 460-470 mc., fixed and mobile 450-460 mc., television experimental 470-500 mc. Equipment capable of doing the jobs of the ordinary set sells for hundreds and hundreds of dollars. The 15 tubes alone are worth more than the sale price. 4-7F7, 4-7H7, 2-7E6, 2-6R6, 2-935 and 1-We316A. It now covers 460 to 490 mc. Each BC-645 is shipped with a Belmont factory printed conversion diagram, showing how to make AC power supply modulator and how to make Transmitter and Receiver changes. Most Ham and experimenters already have the few parts necessary. New BC-645 with tubes less power supply \$14.95
Two for 29.00
12 volt D.C. Dynamotor 4.95
Extra 316A Door Knob tubes 1.29

Brand New Aircraft Receivers BC-454

3 to 6 M.C.

SCOOP PRICE 2.95

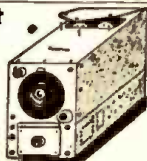

These Army surplus aircraft receivers may be operated from a 24 volt AC filament supply and any low power 250 volt B supply, or the tubes changed to the 6 volt type. There is plenty of room for a power transformer and rectifier tube; in place of the dynamotor. This receiver is very selective and sensitive; has RF stage and BFO. Made by Western Electric and you never saw finer wiring. Offered complete with tubes; 12K8, 9-12SK7, 12SR7 and 12A6, but less 28 volt dynamotor.
BC-454-B—3 to 6 MC superhet receiver with all tubes. Net \$5.95
Less tubes. Net 2.95
28 volt dynamotor (snaps on receiver chassis) Net 1.95
(Shipping weight of above rec. 8 lbs.)

Aircraft Transmitter SCOOP PRICE \$9.95

Up to 55 watts output from these trans, according to what power supply you use. Ideal to make over for a Ham etc. Priced complete with tubes 12J5 and two 1625. Has built in crystal for dial calibration. Used but in good condition.
BC 457 4 to 5.3 MC with tubes. net \$9.95
BC 458 5.3 to 7 MC with tubes. net 9.95

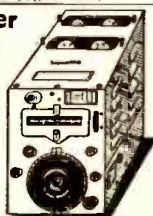

Parts Salvage SCOOP \$2.49

BC 456 WESTERN ELECTRIC MODULATOR. Buy this unit and take it apart for the pieces. Check full of condensers, resistors, relays and tubes VR 150 12J5 1635. Also has a handy modulation transformer which is worth more than our sale price. We have several thousand of these to sell at this scoop price.

BC 456 Modulator with tubes. net \$2.49. two for \$4.49
DYNAMOTOR SCOOP. 28 volts DC input 540 volts at 250 mills output. Scoop price, net \$2.95
NO FULL C.O.D.'S

20% DEPOSIT. BAL. C.O.D. WRITE FOR FLVER.
McGEE RADIO CO.
1223-C McGee St.; KANSAS CITY, MO.

NEW RADIO-ELECTRONIC DEVICES

INTERCOMMUNICATOR

Rauland Corporation of Chicago Chicago, Ill.

The Amplicall master station unit is available with or without handset (for completely private conversation). Distinctive features include visual busy signal, individual locking-type push buttons for station selection, illuminated



ON-OFF volume control, plug-in cable connections, and a balanced line wiring system which prevents cross-talk. Systems are available with facilities for the use of up to 24 master stations, permitting as many as 12 conversations to be carried on simultaneously. — RADIO-CRAFT

PHOTOELECTRIC ACTUATOR

Potter Instrument Company Flushing, N. Y.

The Model 600 photoelectric actuator is a high-resolution instrument for counting pills, buttons, watch screws, bottle caps, hardware, and other such items. The unit has a beam approximately 1/16 inch wide and will respond to changes in light level as small as 20 percent. Since complete interruption

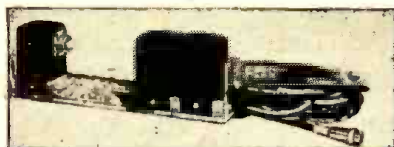

of the light beam is not required for normal operation, objects as small as 10/1000ths of an inch have been counted with absolute accuracy. This feature also permits the counting of objects which do not have a distinct separation.

The actuator provides the negative pulses for operation of electronic counters, and is designed to detect objects at rates up to 30,000 per minute. The unit contains a capacitor discharge output circuit for the high-speed operation of control solenoids such as are required for deflector gates and packaging equipment.

Electronic counters of various capacities, predetermining features, and output circuits also are available for operation with the Model 600. — RADIO-CRAFT

FREQUENCY STANDARD

Hammarlund Mfg. Co. New York, N. Y.

The type FS-135-C frequency-standard unit consists of a precision 100-kc

quartz crystal in an aperiodic oscillator circuit. Provision is made for slight frequency correction to enable the operator to adjust the crystal frequency to exactly 100 kc by zero-beating a harmonic with the standard frequency transmission of the U. S. Bureau of Standards transmitter WWV.

It is completely self-contained except for power supply. Leads are brought out for easy connection to the receiver's power supply. The power required is negligible: 6.3 volts at 0.3 ampere for the tube cathode heater, and approximately 2 milliamperes at 200 volts for the plate and screen-grid supply. The plate and screen potential is not critical and may be anywhere from 100 to 300



volts; recommended voltage is 200 to 250.

The frequency standard is mounted in a drawn aluminum case 2 by 2 inches square, and 1 1/2 inches high, and is equipped with 2 convenient mounting brackets. The tube and crystal are plugged into the top of the unit. With the tube and crystal in place, the total height is approximately 3 3/8 inches. — RADIO-CRAFT

POCKET-SIZE OHMMETER

Sylvania Electric Products, Inc. New York, N. Y.

A miniature ohmmeter has been designed particularly for use by servicemen as a pocket indicator for preliminary isolation of electric faults. In radio set servicing the ohmmeter will indicate transient or other faults in difficult replacements including i.f. transformers,



tuning units, and audio sections; approximate values of individual resistors; and open or shorted conditions in other circuit components. It also provides a direct-reading means for spot-checking automotive electrical equipment, industrial electronic apparatus, home appliances, and experimental or development electrical circuits.

Direct readings between 0 and 10,000 ohms are given on a 1.5-milliamper, full-scale sensitivity Weston meter in series with a 1,000-ohm molded carbon resistor and a penlight dry cell.

The ohmmeter is enclosed in an attractive tubular plastic case $\frac{7}{8}$ inch in diameter and $5\frac{1}{4}$ inches over all. The prod tip base and top cap, constructed of green molded bakelite, are mounted in a transparent cellulose acetate tube housing the meter.—RADIO-CRAFT

PIONEER ATOM SPLITTER

(Continued from page 23)

the passage of a single electron through its gas chamber. Where the number of counts per second is too great for the mechanical relay in the plate circuit of the final amplifier to handle, other circuits have been constructed which supply one impulse to the relay for every two (or higher multiple) counts. These scaling circuits may have a factor of 4, 8 or higher numbers, or may be based on the decimal system, giving an indication for every 5 or 10 counts.

Vacuum-tube quenching circuits further speed up Geiger tube action, by causing the tube to de-ionize more rapidly after each pulse, so that it can count faster and register heavier showers of particles.

The voltage-regulated power supply is by no means to be neglected as a factor in atomic research. Maintenance of voltage within very narrow limits is very important when counters or other instruments are operating over critical portions of their characteristics, as is necessary in some very important types of study.

Regulated voltage supplies, vacuum-tube amplifiers and electronic switching circuits have so extended the capabilities of older research devices as to make them practically new instruments, of which the electronic circuits are fundamental parts. Thus it is not surprising that an important piece of equipment for atomic study and research should resemble a radio transmitter rack.

DEMONSTRATION TRANSMITTERS

(Continued from page 35)

the same time taking advantage of the same audio amplifier and loud speaker for both units and thereby eliminating any change in fidelity from that source.

For the interference source an old model "T" Ford spark coil was wired through a push button to four dry cells and a short length of wire connected to the high tension terminal. This created no small amount of racket in the AM receiver yet was thoroughly eliminated when switching to FM.

RADIO and ELECTRONIC GOVERNMENT SURPLUS

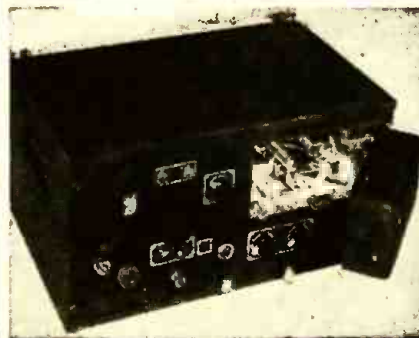

RECORDERS

New and Complete with Tubes

Designed for ink recording of code signals at speeds up to 400 words per minute on $\frac{3}{8}$ inch paper tape. Input may be connected to telephone line transmitting radio signals or directly to output circuit of receiver. Self-contained, only requires connection to power supply and signal source.

Description	Height	Width	Depth	Net Weight
Recorder BC-1016	10 $\frac{1}{4}$ "	x 19 $\frac{1}{4}$ "	x 14 $\frac{1}{2}$ "	80 lbs.

Tube Complement, Vacuum:

- 1 Tube VT-116-A RMA 6S17-GT
- 1 Tube VT-90-A RMA 6H6-GT
- 1 Tube VT-231 RMA 6SN7-GT
- 3 Tubes VT-115-A RMA 616-G
- 2 Tubes VT-244 RMA 5U4-G

Power supply:—Operates on 110 Volts; 50-60 cycle alternating current.

Input signal:—0.75 and 50 volts required for operation. May be obtained several ways, for example:

- a. From receiver connected direct to recorder
- b. From telephone line carrying signal to recorder from a remote location.

\$25⁰⁰

F.O.B. DETROIT

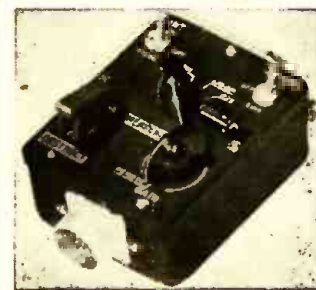

JUNCTION BOXES

50c

Complete with switches, fuse holders, jewels, volume controls and relays.

EACH



BEACON RECEIVERS

BC-1206-C

A light-weight, 5-tube super-heterodyne receiver built by Satchell Carlson. Covers 200-400 Kc radio beacon frequencies. Complete with the following tubes: 2-14H7, 1-14J7, 1-14R7, and 1-28D7. Output impedance 300 ohm with provision for 4,000 ohm by slight circuit change. Operates from any 24-28 V, DC source. Current consumption .75 amp. May be used in light planes by connecting to dry batteries for necessary voltage. No high voltage power supply used which gives the set maximum efficiency. Dimensions: $7\frac{1}{2}$ " x 4" x $4\frac{1}{4}$ ". Weight, 4 lbs. Complete

\$4⁹⁵



VARIABLE CONDENSERS

Four sections 35 Mmfd plus one section 50 and one section 250 Mmfd. Complete

50c

EACH

Write Us About Your Needs

No order under \$5.00—please. Send check or money order. Orders shipped C.O.D. subject to 20% advance deposit. All prices quoted F.O.B. Detroit, Michigan.

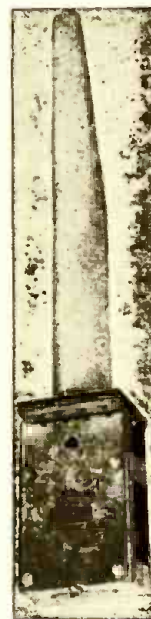

FM ANTENNA

Will receive up to 150 Mc.

\$1⁵⁰

EACH

SPECIALS

- SPAGHETTI—Bundle **35c**
- EAR PHONES—Used, in good working condition—complete **50c**
- METER FACES—20 assorted—sizes 2 and 3 inch **\$1⁰⁰**

RADIO CENTER

2530 E. Davison Avenue
Detroit 12, Michigan

OPPORTUNITY FOR RADIO MEN!

Here's the book that can help you make a real profit in **ELECTRIC MOTOR REPAIR**. It's a logical addition to any service business. It's a really worthwhile profession to know. The field isn't crowded. Every home, every business, every industry uses motors. Train now to be the man who can repair them!



**I'll Make it
EASY for you
to LEARN**

**PROFITABLE
ELECTRIC MOTOR
REPAIR . . .**

**.. at only \$5 for the
complete, 553-page
Course!**

ELECTRIC MOTOR REPAIR, a big, brand-new book by the publishers of famous Ghirardi Radio-Electronic books is a gold mine for radio men who want to expand along logical, profitable lines in an uncrowded field. Based on this big book alone, you can train for prompt, profitable service on practically ANY TYPE OF MOTOR IN COMMON USE—from small, fractional horsepower motors in home appliances, to the larger industrial motor. It tells exactly how to do everything from making simple adjustments and repairs to complete motor rewinding. Covers AC and DC motors, synchronous motors and generators and BOTH mechanical and electrical control systems.

**IT PAYS TO SPECIALIZE IN
"SOMETHING DIFFERENT"**

Every step of the work is explained simply as A-B-C, both in text and by more than 900 specially prepared diagrams and illustrations. No guesswork! Each phase of motor repair is clearly shown so there can be no mistaking as to what should be done and why. Quick reference guides show step-by-step how to handle specific jobs. When a motor comes in for repairs, just turn to **ELECTRIC MOTOR REPAIR** and see what to do. It's an ideal book, either for beginners or for day to day bench use in busy shops.

Unique Duo-Spiral Binding divides book into two sections with text on one side, pictures on the other. Lies flat on the bench. Both text and related illustrations are visible at the same time.

Good coupon now. **PRACTICE** from **ELECTRIC MOTOR REPAIR** for 5 full days—**AT OUR RISK**. Then, if not more than satisfied, return book to us and **EVERY CENT OF YOUR MONEY WILL BE COMPLETELY REFUNDED**. No questions asked!

**"BORROW" IT FOR
5 FULL DAYS!**

NO RISK COUPON mail today

DEPT. RC-67, MURRAY HILL BOOKS, INC.
232 Madison Ave., New York 16, N. Y.

Enclosed find \$5 (\$5.50 outside USA) for my copy of the big new **ELECTRIC MOTOR REPAIR** book; or I send C.O.D. for this amount plus postage (no foreign C.O.D.'s). If unsatisfactory for any reason, it is understood I may return book in 5 days for complete refund of my money.

Name

Address

City and Dist. No. State

New Radio-Electronic Patents

By I. QUEEN

TELEVISION SWEEP CIRCUIT

Patent No. 2,393,601

Millard W. Baldwin, Jr., Glen Ridge, N. J.

This invention is an improvement over existing circuits which govern the deflection of an electron beam by electromagnetism. The magnetic type of cathode-ray tube is advantageous where the necessary deflection power is available, as in television reception, since the tube can be smaller and simpler. Since the special features are associated with the vertical sweep circuit, it need only be mentioned that the horizontal sweep is controlled by a suitable oscillator and deflection coils according to present-day procedure.

The vertical sweep circuit uses three tubes, the last two in push-pull for second-harmonic reduction. The input triode is triggered by periodic pulses which cause the tube to conduct and therefore discharge the condensers C. These charge again from the battery through any well-known constant current device and the cycle repeats.

The output of the push-pull stage flows through the coils L1 and L2 and it consists in general of a residual d.c. component and the signal a.c. component. For convenience consider the first portion alone, that is, in the absence of a signal. During these intervals there should be no vertical deflection of the beam. The deflection coils ordinarily carry the current of only one of the push-pull plate currents, and as a result the two equal and opposite currents balance out only near the center of the scope tube. This means that when an electron is near the end of its

principle of hysteresis—often known as magnetic inertia because it imposes a lag between an exciting current and the electromagnetism which results.

Two windings are placed over a suitable iron core. An a.c. source excites the primary, one half of which is wound in opposition and in series with the other half. The entire secondary is wound in one direction. If the core is in field-free

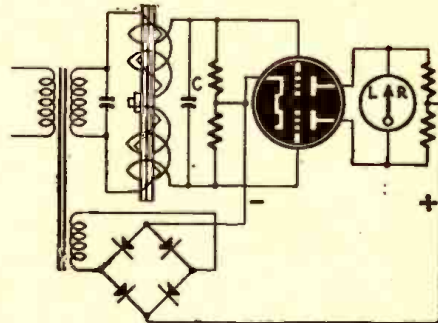

space, it may be considered as composed of two equal and opposing electromagnets, end to end. Since hysteresis lag depends upon peak magnetism, it is equal for each half of the core in this case and there can be no induced secondary voltage.

If the core is surrounded by a magnetic field (for example that of the earth) the two halves of the core no longer have the same peak magnetism since one is strengthened and the other weakened during any given half-cycle of exciting current. As a result, the hysteresis lag is increased in one of the core "magnets" and is decreased in the other; so there is a distortion of the previously symmetrical field variation.

The effective electromagnetic field now has a component which varies at a frequency twice as great as that of the exciting current. Condenser C tunes the secondary winding to this frequency and the induced voltage is amplified and detected by a meter. The deflection may be either to the right or left depending upon the direction of the magnetic field being

measured. The field intensity is shown by the output current magnitude. Note that the plate potential for the tubes may be obtained from the same a.c. source that supplies the electromagnetic primary.

This device may be used as a magnetic compass. The meter will indicate a peak reading when the core is pointed toward magnetic north and south.

UNDERWATER DETECTION

Patent No. 2,410,065

Bertram M. Harrison

(assigned to Submarine Signal Co., Boston)

Power at superaudible frequencies is generally used in devices for underwater detection of objects. A sharp pulse is transmitted (periodically) and is subsequently received as an echo. The time interval between the two instants measures the distance of a target. Because of the very short time between transmission and reception of a pulse, it is difficult to prevent blocking of the receiver. An effective method has been devised in this invention.

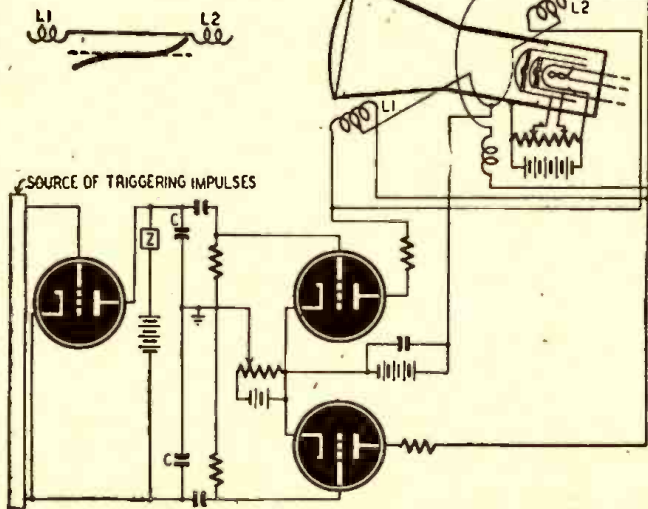

travel (along a horizontal line), one or the other of the magnetic fields will predominate and cause the beam to be deflected even though no signal is coming through. Therefore the television picture will be distorted along the two sides. In this circuit, each deflection coil is center-tapped and each half carries the current from one tube. As a result, the two opposite and equal fields cancel out in each coil. Under this condition there is practically no magnetic field due to the d.c. component of the push-pull tubes and therefore no vertical deflection without signal input.

MAGNETIC MEASUREMENT

Patent No. 2,410,039

Lennox F. Beach

(assigned to The Purves Corporation,
Springfield, Mass.)

Measurements of magnetism are inherently indirect and often difficult to make. This electronic method simplifies the process and is capable of high sensitivity and accuracy. It operates on the

The figure shows the new method as applied to one type of detector. A shaft rotates at constant speed and carries with it a disc and a cam arrangement. The disc is equipped with a thin vertical slot behind which is fixed a neon tube. One terminal of the discharge tube is fed through a brush and commutator B and the other is grounded.

The cam is first adjusted so that it closes the contacts and actuates the transmitter at the

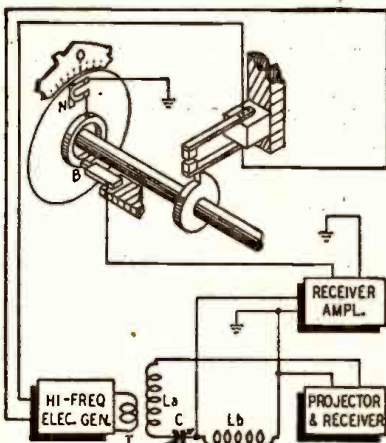

instant that the slot corresponds to zero on the scale. Received pulse echoes are applied across the neon tube which is caused to glow during such instants. Since transmission of a pulse takes place while the slot is at zero, the echo will arrive after the slot has moved to some other position. If the scale calibration is marked off in suitable units of distance, the range of an object is indicated directly by noting the point at which the neon tube flashes.

Receiver blocking is accomplished by the network La, Lb and C. The reactance of La is designed to be equal and opposite to that of C. The reactance of Lb and that of the projector are such that only a fraction of the total circuit voltage appears across the inductance. During transmission of a pulse, therefore, only a fraction of the total voltage is present across the receiving amplifier. The amplifier input and Lb are designed to be parallel-resonant at the super-audible frequency being used. Therefore the entire received voltage is effective across the amplifier.

MULTI-CHANNEL U.H.F. RECEPTION

Patent No. 2,394,917
Heinz E. Kallmann

High-frequency broadcasting (including FM, television, facsimile) has created special problems which differ greatly in several ways from those of AM broadcasting. For example, the line-of-sight limit makes it desirable to use directional antenna systems. Also an accurate impedance match should be made throughout, since wave reflections often seriously distort a received picture. The wide modulation bands require special design in the antenna and receiving units, and limit the number of available channels.

This patent proposes to use separate antenna systems for each station within range, thus making it possible to tune, orient, and match each for optimum picture or sound reception. The various outputs feed a single transmission line designed for low loss at ultra-high frequencies. Fixed-tuned receivers then may be connected across the line where desired. In some cases, it may be desirable to convert the original high frequency to a lower carrier frequency or even to demodulate before feeding the line, thus simplifying the apparatus necessary to reproduce the signal from the line.

This invention should be especially applicable to large apartment buildings and hotels.

ROTA-BASE

NEW HANDY LAB. DIAL actually gives a "prong" picture of radio tube connections. Simply turn the dial to the tube number desired on the ROTA-BASE and complete correct connections are instantly indicated on the "prong" diagram. No more valuable time lost thumbing pages or on lengthy readings. Filament, grid, plate, cathode, etc. TO MORE THAN 300 tube types are given. PRICE NOW ONLY \$1.00 postpaid or sent C.O.D. plus postage. Order NOW, money refunded if you are not delightfully pleased. 411 S. Main St. REED MFG. CO. Los Angeles 13, Calif.

JUNE LEOTONE SPECIALS

Minimum Order \$2.00—20% Deposit Required on all orders. Please Add Sufficient Postage. WRITE DEPT. RC-6.

SELENIUM RECTIFIERS—Half wave, Max. input 50 V. AC @ 1 amp; approx 25% volt drop when used in full-wave bridge. With hook-up for half or full wave rect. 1 1/4" O.D. Each 69c; 4 for \$2.49

Weston #301, 0-50 voltmeter (modulation) AC rectifier, 1000 ohms per volt, 3" bakelite. 3.85

Wafar Local Sockets, 1 1/4" mtg. Each 6c; 20 for 1.00

Variable Condensers, 2 gang, 305 mmfd. All with trimmers, 3/8" shaft, 13/16" long; Cadmium plated.75

Precision Resistors, 1% wire-wound. Ohmage: 2.35, 11, 24.5, 100, 3300, 5200, 7800, 30K, 50K, or 400K.35

5AC Fuses, heavy duty cartridge, 1 or 3 amps @ 250V (1 1/2" x 3/8"). Either .08; 12 for 1.00

AC-DC NEON TEST-LITE, use as probe or fixed indicator from 90V. up. Each .15; 8 for 1.00

ALNICO MAGNETS

- #1—Bar, 8 1/4" x 5/10" x 1/4" \$.50
- #2—Face 1 1/4" x 1 3/4" x 1/8" high98
- #3—Heavy duty bar, 2 1/2" x 1 3/4" x 5/16"98
- #4—Face 3/4" x 1 1/2" x 1/8" high39
- #5—Polished, 7/8" x 1 1/2" x 1/8" high98
- #6—Polished bar, 9/16" x 1 1/4" x 1/8" 20 for 1.00
- #7—Face 1 1/2" x 1 1/2" x 1/8" high10
- #8—ALNICO V shoe, poles 3/8" sq; 1 1/4" high75
- #9—ALNICO V, h shoe, poles 9/16" sq; 1 1/4" high98
- #10—ALNICO V, h shoe, poles 1 1/2" x 1 1/2" x 2 3/4" high 5.95
- #11—Horseshoe, ea. pole 1 1/16" O.D., 2 1/4" high 1.29
- #12—Similar to #5 3/4" x 3/8" x 1/16"35
- #14—Polished hvy duty bar, 3/4" x 1 1/4" x 7/8" (generalized lengthwise wide or narrow sides) 1.29
- #15—Polished Block, 3/4" x 2 3/4" x 1 1/2"; magnetized wide or narrow sides (wt. 3 lbs) Unmagnetized 2.47 1.95
- #16—Flat Bar, 1 7/8" x 1 5/16" x 5/16" thick;40
- #17—Circular, 1 1/16" O.D., 3/8" hole; semi-circular poles on flat sides49
- #18—Round bar, 1/4" O.D., 5/16" long. Polished19
- #19—Round h shoe, 1/2" O.D., 7/16" high12
- #20—Round bar, polished, 1/2" O.D., per inch07
- #21—Round bar, polished, 5/8" O.D., per inch35
- #22—Round bar, polished, 5/8" O.D., 1 1/4" long39
- #23—Round bar, polished, 5/8" O.D., 2 1/2" long59
- #24—Round bar, polished, 5/8" O.D., 4 1/4" long 1.25
- #25—Round bar, polished, 5/8" O.D., 5 11/16" long 1.49
- #26—Round bar, polished, 3/4" O.D., 2" long49
- #27—Polished block, 3/4" x 3/4" x 3/4"39

Telegraph Key and 8V Buzzer (Western Electric). Gap & tension adjust; bakelite base. \$1.29

Telegraph Key only, Adjustable platinum contacts. Bakelite base.49

Mr. Guire Changer Pick-up Arms (Astatic). Light, cast metal, brown enam. finish. Less L-70 type cartridge69

SPECIAL 11—GIANT "GRAB-BAG" RADIO PARTS KIT. A real buy for the Serviceman, Amateur or experimenter. 15 FULL POUNDS of useful resistors, condensers, coils, wire, speaker repair parts, hardware, transformers, etc., etc. An amazing value at **\$1.95**

SELSYN Control Transformers (#2J101). Original, by 110V-400 cycle, will operate on 20V, 60 cycles. 1.95

SELSYN Synchro-Transmitters (type VII) 115V, 60 cycle. Used in pairs as trans. & follower. 3 1/2" x 5 1/2", ea. 3.75

2-Meter Frame & Housing (round). Complete with glass & adjust screw. 1" deep.39

Weston 2301 meter glass & frame; adjust screw.89

EXPERIMENTAL TUBES, 20 asstd. receiving types for testing, research, etc. Filament tested. 1.00

TUBES: Perfect condition, but not in sealed cans. Guaranteed for 90 days.

- #26, 27 or 50-29c; #42, 45, 75, 77, 78, 80, 89, 6Y3, 6H9 or 6K7.39
- #8A8, 6CS, 6F5, 6J7, 6SK7 or 35/5143
- #1A7, 6A3, 6G5/6U5 or 50.59

Brand new R.C.A. UX-200 tubes in sealed cans. Ideal triode detector—3 for. 1.00

SPEAKER GRILLES, 5 1/2" sq. Flocked musical design on gilt perforated metal.19

Speaker Grille Cloth, Decorative fold or silver weave. Per sq. foot \$1.2520

Cone Centering Shims, Kit of 16 (4 thicknesses) in durable leather case35

HEADPHONES (Army HS-33) 2000 ohms. Leather covered, adjustable. With PL-54 plug.20

HS-18 2000 ohm Phones (2-R14 receivers) with 13" double cord & PL-54 plug.95

HEADBANDS (HB-7) with PL-54 plug & cord.39

PL-54 plug & 13" tipped 2000 ohm phone cord, 19.39

JK-28 ext. jack for PL-54. Bakelite shell.23

SERVICEMEN'S KITS

- #1—R.F., Antenna & Osc. coils, 10 asstd \$.98
- #2—Speaker Cones; 12 asstd. 4 to 12" molded & free-edge (magnetic incl.). Less voice coils 2.00
- #3—BAKELITE MICA CONDENSERS; 50 asstd. 00001 to 2 mfd. 200-300 WV. Clearly marked 2.95
- #4—TUBULAR BY-PASS CONDENSERS; 50 asstd. .001 to 25 mfd. 200-800WV. Standard brands 2.49
- #6—Dial Scales; 25 asstd. aluminum & aldo rulo (acrylic & glass included) 2.98
- #7—Escutcheon plates; 25 asstd. airplane, slide-rule & full-union types 2.95
- #8—Knobs; 25 asstd. wood & bakelite, including push-on & set screw types. 1.00
- #9—Water Sockets; 12 asstd. 4 to 7 prongs 2.25
- #10—Voltage Dividers; 10 asstd. standard multi-tapped. High wattages included 1.98
- #11—Shield Cans; 15 asstd. for coils, tubes, transformers, etc. 1.00
- #12—Mica Padders & Trimmers; 15 asstd. including multiple & ceramic base types69
- #14—Volume & Tone Controls; 10 asstd. wire-wound & carbon. Less switches 1.49
- #15—Wire-wound Resistors; 15 asstd. ohmage, 3 to 20 watts98
- #16—IP Coils; 6 asstd. including shielded & slug tuned. Peaks unmarked. 1.95
- #17—Dial Windows; 12 asstd. sizes, incl. flat & moulded acetate and convex glass 1.29
- #18—Bakelite Coil Forms; 18 asstd. popular sizes up to 3" diameter98
- #19—High Resistance Units; 25 asstd. 1 watt, carbon & wire, ferrule-end, 25K to 5 megohms49
- #20—SPEAKER REPAIR KIT. A real money & time saver. Contains: 25 asstd. paper rings, 10 splinters, 25 asstd. voice coil forms, 3 yds. of 1/2" chamamois leather segments, kit of 18 shims & tube of speaker cement. All for 2.49
- #21—Metal Cased By-Pass Condensers; 10 asstd. paper-wound, multi-section 200-400WV49
- #22—Resistor Assortment; 20 carbon and wire-wound, asstd. ohmage, 1/3 to 3 watts49
- #23—RADIO CEMENT & SOLVENT KIT. Contains 3 oz. each of all-purpose cement & solvent (thinner). With applicator brush69

Bendix Amplifier (Line of Sight) rotary indicator, 115V, 400 cycle. Contains: power trans. 3 audios, 6 oil condensers plus other components worth many times the price. Black crackle case. 7"x5 3/4"x4" 1.05

"OUNCER" INPUT TRANSFORMERS (7/8" x 2 1/2") 350 ohm. mks to grid; 58-Dynamic mks or low impedance pick-up to grid. Either.49

12 for 5.00

Frequency Meter Tech. Manual (Navy) Theory & Operation; 39 illus. & diagrams. 58 pp. \$ 1.15

RADIO HARDWARE TREASURE. An indispensable assortment of approx. 1000 screws, nuts, washers, etc.49

Victor Power Transformer for models R-32, 45, 52 or 75. Unshielded 5.95

ALUMINUM PANELS (L0517), 7"x10"39

7"x12"—481, 7"x14"—49, 7"x18"59

BAKELITE PANELS: 1/4" glossy brown, 7"x10"69

7"x14"—69; 7"x18"—79; 9"x14"85

1/8" Linen Bakelite Strips, 1 1/2"x1 1/2", 3 for.39

"Acro-Snap" Momentary Switch SPDT, needle plunger (2 oz. pressure) 10A/125V. Bakelite case39

11 PHONO MOTORS 1 1/2" Twin-coil 110V, A.C. quiet rim-drive, fan cooled. With 9" turntable 2.95

DYNAMOTORS (Navy DY-0) DC Input; 26V; DC output; 360V @ 135ma or 310V @ 355ma. Black crackle finish with mtg. base 6 1/2" x 3 1/2". 3.95

PROMPT SERVICE ON ALL SPEAKER AND PHONO PICK-UP REPAIRS

LEOTONE RADIO CO.

MAKERS OF CONES AND FIELD COILS

65-67 DEY STREET, NEW YORK 7, N.Y.

WORTH 2-0284-5

12,000 SQ. FT. OF RADIO PARTS

QUIK-LABELS CODE CARD SYSTEM

Removable Self-Strip exposes ends of Labels for you to peel!

DON'T PICK. USE SELF-STARTER STRIP TO PEEL LABELS.

1	2	3	4	5	6	7	8	9	10	11	12	13	14	15	16
1	2	3	4	5	6	7	8	9	10	11	12	13	14	15	16
1	2	3	4	5	6	7	8	9	10	11	12	13	14	15	16
1	2	3	4	5	6	7	8	9	10	11	12	13	14	15	16

QUIK-LABEL
T.M. & C. - PAT. APPL. FOR
Code Card System
MFD. BY
W. H. BRADY CO., INC. CHICAGO

FREE SAMPLES

DON'T PICK. USE SELF-STARTER STRIP TO PEEL LABELS.

1 PEEL 2 APPLY 3 IDENTIFY

LIKELIKE ON FLAT SURFACES

*Patents Pending

QUIK-LABELS code Wires, Leads, Circuits, Relays, Parts, etc., faster and cheaper. ● Pre-cut to exact size, QUIK-LABELS come on handy cards. ● Ready to use, they stick-quick without moistening, replace slow and costly string tags, roll tapes, decals, stencils, metal tabs, etc. ● Resist dirt, grease, oil, abrasion. ● *Self Starter Strip automatically exposes ends of Labels for you to grasp instantly—no more finger-picking.

W. H. BRADY COMPANY Established 1914
Manufacturers of Self-Sticking Tape Products
802 N. 3rd STREET, MILWAUKEE 3, WISCONSIN
I'm interested. Send me all the facts on QUIK-LABELS.

Name _____ Title _____
PLEASE ATTACH TO YOUR COMPANY LETTERHEAD

COLOR TELEVISION (Continued from page 40)

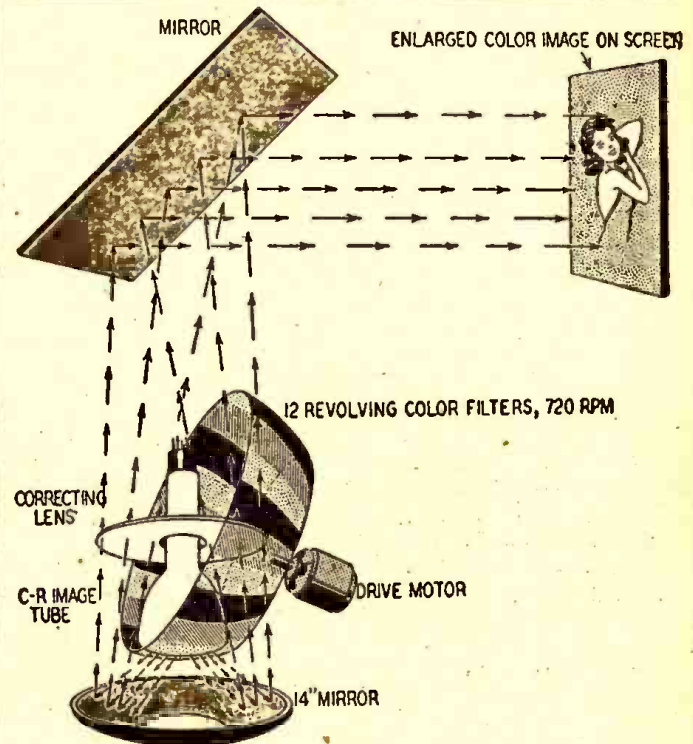

Fig. 5—Sequential color receiver, showing how color is restored.

ARMY-NAVY HEAD PHONES \$2.49

B-A made a lucky buy. Genuine U. S. Signal Corps head phones, 8000 highly sensitive, bi-ohms magnets. Only polar magnets. \$2.49 a pair plus 20c postage and pkg. chgs. Retail value \$13.50. Order No. 17A37.

FREE Catalog

GET THIS catalog, latest developments in radio and electronic parts and devices, newest ham gear, gadgets and bargains.

BURSTEIN-APPLEBEE CO.,
1012 McGee St., Kansas City 6, Mo.

Send me your new FREE catalog.

Send me _____ pairs of phones at \$2.49 plus 20c pair postage. I enclose \$_____ in payment. RC

NAME _____

ADDRESS _____

TOWN _____ STATE _____

POWDERED IRON CORES

Make your own high "Q" I.F.-R.F. or Antenna coils! Range 100 kc to 50 mc.

KIT No. 1—18 Pieces, 3 Types.....\$2.00 pp

Also, perm. tuning cores—1700 kc to 535 kc
KIT No. 2—12 Pieces, 3 Types.....\$3.25 pp

MAGNA-METAL PRODUCTS CO.
70 E. 45th St. New York 17, N. Y.

RADIO KITS ARE TOPS
FOR FUN AND ACCOMPLISHMENT

Build this portable radio Model 210... a three-way portable receiver, operating on either AC or DC or self-contained batteries—power switch conveniently located on front of set so that "Battery" or "AC-DC" may be selected without opening case. Five-inch Alnico 5 permanent magnet dynamic speaker, and case covered with weather-tested aircraft material. Accompanied by simple, detailed instruction sheet. Price \$18.95

Available at your local distributor. If not, write to us. Many other models available. Write for Catalog M

RADIO KITS COMPANY
120 Cedar Street, New York 6, N. Y.

SPECIAL BUYS!
WESTINGHOUSE & G.E.

DYNAMOTORS B & D—input 27 V @ 1.4 amps, output 255 V @ .06 amps or same input with 260 V output at .07 amps. Special, ea. \$1.35

Selsyn differential motor 115 V 60 cy. can be used as high speed motors approx 1/70 hp with slight emersion (conversion data sheet supplied), ea. \$1.75

100 Assorted Resistors, including eight 2 W resistors \$1.75

50 Assorted Mica Condensers..... \$1.95

1—1 mf 7000 V.D.C. GE pyranol, ea. \$1.95

Five air trimmers ceramic insul. Assorted Values \$1.00

Minimum order \$3.00 FOB Philadelphia

Reliance Merchandizing Company
Arch at Croskey Street Philadelphia 3, Pa.

of each tube, as Fig. 1-b and Photo E show. The 3 color beams are flashed onto a mirror, which reflects and blends them on a translucent screen. The observer sees a single composite color image or picture on the screen, the size of the image being 15 x 20 inches. The receiver is of the projection type and is not adapted to direct viewing, at least in its present design. About 45 tubes are used in the receiver; this includes sound.

In the tests conducted at Princeton, N. J., for the FCC, color images were transmitted by radio for a distance of about 1/2 mile, using a frequency of 520 mc.

For comparison it is interesting to note that the RCA console receiver for B & W reception, with a 10-inch tube for direct viewing, has 30 tubes. The B & W projection receiver for an image 15 x 20 inches has 45 tubes.

One of the advantages of the simultaneous color system is that a standard black and white receiver can be fitted with a nominally priced frequency converter so that B & W images may be picked up from a color broadcast. The converter permits the receiver to pick up the green carrier, and as this contains all the essential picture-characteristics and the synchronizing signals, a satisfactory B & W picture can be reproduced on the receiver. This prevents obsolescence of B & W television receivers purchased in the past few years. The B & W receiver cannot pick up its images in color, of course. To do that a color receiver must be used. A sequential receiver must be of the dual type, fitted with changeover switches, to pick up

(Continued on page 59)

TELEVISION FOR TODAY

(Continued from page 37)

causes this separation of ions and electrons is obtained from a small coil placed on the outside of the neck of the tube, above the cathode. The 10AP4 tube is a commercial tube which employs this type of ion trap.

Yet another method of practically eliminating the ions is the type of electron gun shown in Fig. 9. The electrons and ions, when emitted from the cathode, tend to spread out. If a strong magnetic field is applied at this point, the electrons can be made to converge and pass through an extremely small aperture and into the main focusing and deflection fields. Again, the heavier ions

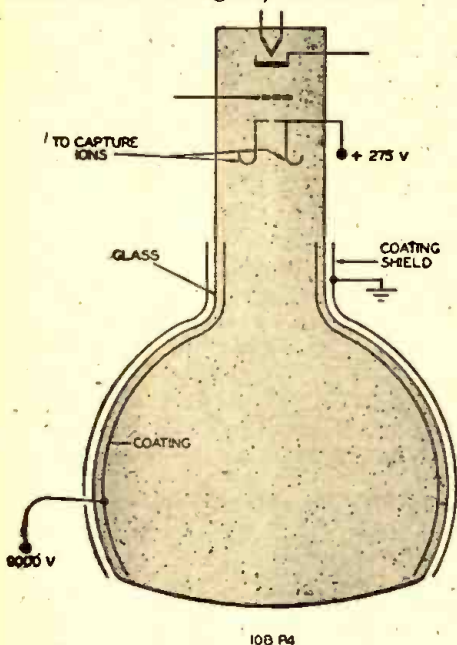

Fig. 9—A method of eliminating the ion spot.

do not react to the magnetic concentrating field but continue to diverge until they reach a positively charged electrode and are conducted back to the cathode. Those ions which leave the cathode in a straight line do pass through the small aperture and into the electron beam. However, the percentage of them is extremely small and no visible damage is caused. A tube with this type of gun is used in the latest RCA television receivers.

The proper position of the bending coils for the ion trap is at the end of the tube neck close to the tube base. In adjusting the set, the coils are moved until the scanning raster or image is brightest. The coil clamps are then tightened securely.

A third method of preventing ions from reaching the screen is accomplished by the aluminum layer mentioned previously. The ion, with its greater mass, does not penetrate as deeply into the aluminum screen as does the electron. By properly determining the thickness of the metal screen, ions are excluded, while the electrons in the beam are able to pass through.

This article closes the series. Comment from readers, or suggestions as to other subjects for similar treatment, is invited.

MONEY TALKS!

DOUGLAS OFFERS

The Lowest of Low Prices on the Map!

AMPLIFIER KIT! Complete with tubes and punched chassis for use on phonograph or mike. Special \$10.43
PHONOGRAPH KIT! Complete with all parts Motor, turntable, pickup and cabinet for use with above amplifier. Special \$10.95
SPEAKER KIT! Complete with 5" "Ainco" speaker and cabinet. Special \$4.58
MICROPHONE KIT! Complete with stand and cable for use with amplifier. Special \$5.58

METERS AT SPECIAL PRICES

Marlon 3" 0-1 ma, 0-500 ua, 0-30 ma, 5 ma, 50 ma—choice of any—Your special price \$2.50
 Marlon 4" 0-200 ua 1 mill, 500 ua, 1 ma, 0-200 ua, 0-500 ma, 0-30. Choice of any, your special price \$3.75

BEST BUY IN RECORD CHANGERS

Detrola Model 550—changes 12-10" or 10-12" records automatically. Special \$13.95
I.R.C. RESISTOR ASSORTMENT—100 Popular Sizes—Special \$1.95

SPECIAL

CATHODE RAY TUBES 5 BPT Sylvania \$4.95
VERTROD NOISE REDUCING ANTENNA for communications, broadcast and short wave receivers Special \$1.25

without noise. Models 102-103 Complete. List \$11.00. Yours for \$5.50
F.M. AND TELEVISION ANTENNAS from \$4.75 up Deluxe Meter Cases for 2-3/16 or 2-13/16 Mtr. Special \$1.15
 Other sizes available at discount prices
 Chassis 5 x 9 1/2 x 1 1/4—20 gauge steel black finish 53c
NE-O-LITE new electric trouble shooters—can be used on 60 volts AC to 500 Volts AC or DC. List 50c. Yours for 25c
PLASTIC PLIERS—6000 Volt Breakdown—Deal for hot work. List \$1.50. Your cost 75c
POWER TRANSFORMER 700 Volts C.T. 70 ma 5 Volt, and 2 2.5 Taps. Lists for \$6.60. Yours for \$3.30
AC DC CHOKE 4.5 henries 50 ma 200 ohms. Lists for \$1.45. Yours for 74c
FILTER CHOKE 4.8 henries, 100 ma 275 ohms. List \$3.05. Yours for \$1.50
NEW G.E. RELUCTANCE PICKUP CARTRIDGE. \$4.56
ALLIANCE PHONO MOTOR AND ASTAT-C PICKUP KIT. Special \$4.95
 1/2 Meg Volume Control and Switch Special 49c
 5" AInco P.M. Speaker \$1.75
 Variable Condensers for Superhet Special \$1.10
 Variable Condensers for T.H.F. Special \$1.25
 Special C.D. 2 mfd 600 V can type 39c

TUBES—COMPLETE LINE OF ALL HARD TO GET TUBES. SEND US YOUR ORDER AND WE WILL SURPRISE YOU WITH PROMPT DELIVERY AT DISCOUNT PRICES.

If it's hard to get—we have it!!

25% Dep. on C.D.D.

Send for Free Catalog

BA 7-3956

Add postage under \$5.00

DOUGLAS RADIO SUPPLY CO.

DEPT. A.

128 GREENWICH STREET

NEW YORK, N. Y.

VERIFIED SPEAKERS

"They Speak for Themselves"

DISTRIBUTORS enjoy selling them because they make friends and build business. The **VERIFIED GUARANTEE** back of the distributor enables him to immediately replace any defective speaker with a new one . . . saving time and money for the **RADIO SERVICE MAN.**

LIVE BRILLIANT TONE



2233 UNIVERSITY AVENUE
WRIGHT, INC., St. Paul 4, Minnesota

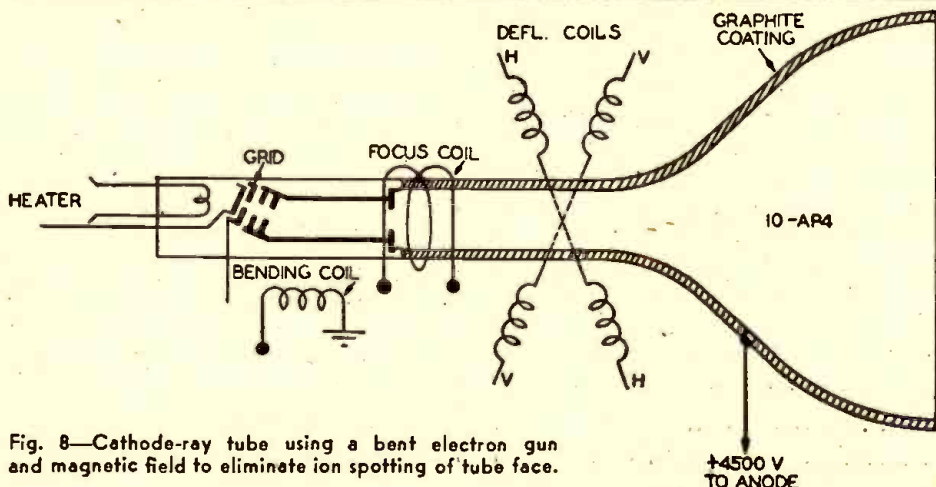

Fig. 8—Cathode-ray tube using a bent electron gun and magnetic field to eliminate ion spotting of tube face.



Now Ready



The Two Latest Titles in the
RADIO CRAFT NEW LIBRARY SERIES
 50¢ each
Nine Recent Titles

- # 29 HANDY KINKS AND SHORT CUTS
- # 30 UNUSUAL PATENTED CIRCUITS 1944-1946
- # 31 RADIO QUESTIONS AND ANSWERS
- # 32 ADVANCED SERVICE TECHNIQUE
- # 33 AMPLIFIER BUILDER'S GUIDE
- # 35 AMATEUR RADIO BUILDER'S GUIDE
- # 36 RADIO TEST INSTRUMENTS
- # 37 ELEMENTARY RADIO SERVICING
- # 38 HOW TO BUILD RADIO RECEIVERS

Two more titles in this popular new series are now available. The two latest—described below—like the others, give you the most recent, reliable technical information and are as modern in appearance as 1947 radios and cars. The type is fresh, clear-cut, easy to read. The books are bound in flexible covers, smartly designed. In short, everything connected with these volumes is up-to-the-minute and practical to the nth degree. You'll find them constructive helps in building up your knowledge of radio.

NO. 31. RADIO QUESTIONS AND ANSWERS

Here are the answers to questions most frequently asked of the "Question Box" editor of RADIO-CRAFT. The material selected is well diversified and chosen for practical application to workaday problems. Circuit diagrams are supplied with the answers.

NO. 35. AMATEUR RADIO BUILDER'S GUIDE

A book for the amateur operator who builds his own. Practical and down-to-earth, it tells you how to build transmitters, receivers, and other ham gear. Construction data on a 430-mc transmitter, an HK-24G c.w. transmitter, a miniature communications receiver, an acorn-tube preamplifier, and many others. Whether you're an amateur now, or just studying for your ticket, you'll want this book.

SEE YOUR DEALER IF HE CAN'T SUPPLY YOU. USE COUPON

CAN YOU ANSWER THESE?

Employees of Collins Radio Co., Cedar Rapids, Iowa, are expected to pass a technical examination to show their knowledge of the work they are to perform. A passing grade entitles the applicant to a trial period on the job which, if successfully completed, leads to a permanent assignment.

The following are sample questions taken from an examination for a "Test Technician B" position.

1. In a radio frequency amplifier stage having a plate voltage of 1,250 volts, a plate current of 150 milliamperes, a grid current of 15 milliamperes, and a grid leak resistance of 4,000 ohms, what is the exact operating grid bias value?
2. Sketch a block diagram of a crystal-controlled transmitter, using a buffer stage and high-level modulation.
3. Why is the distributed capacity of a coil always increased by the wax or other coating used for protection against moisture?
4. How is the vacuum-tube plate current of an r.f. amplifier affected as the plate-circuit resonant frequency is varied?

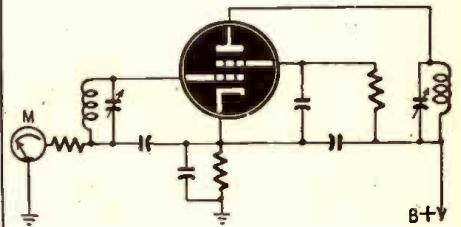

5. The above is a circuit of an r.f. amplifier. What is the fundamental difference between the action of the meter if the tube is operating Class C from what it would be if the tube was operating Class A?
6. What are the principal output voltage ripple frequencies in a full-wave rectifier?
7. What is the relation between the direct-current power input of the plate circuit of the stage being modulated, and the output audio power of the modulator for 100 percent sinusoidal modulation?
8. Sketch a block diagram of a super-heterodyne receiver showing an audio frequency stage, radio frequency stage, audio power amplifier stage, speaker, mixer, second detector, and intermediate frequency stage.
9. What is the sum of 25 cycles, 25 kilocycles, and 25 megacycles?
10. What is a "parasitic oscillation"? —*The Collins Signal*, Jan., 1947

[Answers for these questions next month, if you need 'em! Write in and ask.]

RADCRAFT PUBLICATIONS, Dept. 67
 25 West Broadway, New York 7, N. Y.
 Send me the volumes (50c each, postpaid) checked. My dealer is unable to supply.

I enclose \$.....
 Your Name
 Address
 Dealer's Name
 Address

() ALL NINE BOOKS

- 29 35
- 30 36
- 31 37
- 32 38

Get this New RADIO RULE!



Needed by all radio engineers, draftsmen and technicians. This accurate 8-inch symbol rule saves you time and money. Sent immediately upon receipt of \$1.00.

COLETTE PRODUCTS CO.
 413 Fox Theatre Bldg., Dept. A, Detroit 1 **ORDER TODAY**

COLOR TELEVISION

(Continued from page 56)

black and white images as well as color pictures.

Simultaneous-type color receivers can pick up and reproduce images broadcast by B & W stations, with the aid of an adapter. The adapter is needed only because the color band is at a higher frequency than is covered by B & W receivers, and would be needed to receive B & W transmissions on those fre-

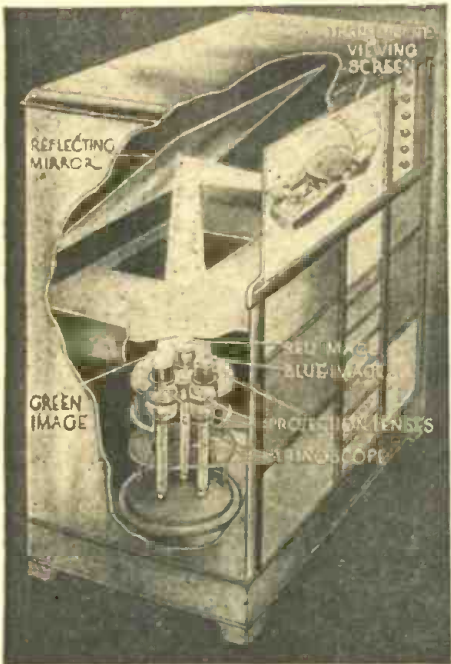

Photo E—A simultaneous television receiver.

quencies. At the present development stage, a mechanical or sequential color receiver cannot pick up a simultaneous image, either in color or as a black and white monochrome.

Among some of the advantages claimed for the *simultaneous* color system are: narrower band width than that required for sequential transmission; greater freedom from flicker; no color fringing and no color breakup; greater fidelity in picture detail and superior picture brightness for comparable size of images; superior flexibility for network broadcasts.

The second part of Mr. Secor's article—to appear in an early issue—will describe three other proposed methods of color television.

COMMERCIAL PARADISE

Commercial announcements on the Brazilian ether are so frequent and lengthy as to cause one American broadcasting magazine editor to evolve a theory that the Brazilians must like 'em. As many as 20 spot commercials may be broadcast successively, with no program material.

Proof that the people like this type of fare is entirely lacking, and the fact that there is only one radio for every 50 inhabitants of the country might be adduced as evidence to the contrary.



A. A. Ghirardi
POSITIVELY
GUARANTEES
to help you repair any
radio ever made EASIER
BETTER & FASTER

or refund every cent of your money!



GUARANTEED
TO HELP YOU LEARN
Professional RADIO-
ELECTRONIC REPAIR,
at home, without
an instructor



GUARANTEED
TO HELP YOU REPAIR 9
OUT OF 10 RADIO TROU-
BLES Twice as Fast, without
costly test equipment

THE ONLY COMPLETE, 1 VOL. COURSE OF ITS KIND!

Once in a lifetime, a technical book is written that is so important, so complete and easy to understand that it is used almost universally by members of an entire profession—and Ghirardi's MODERN RADIO SERVICING is exactly that kind of a book. It gives a course in radio-electronic repair work by approved scientific methods. Included is a thorough explanation of Test Instruments, how they should be used and why—even how to build your own; Receiver Troubleshooting Procedure and Circuit Analysis; Testing and Repair of All Components; Installations; Adjustments, etc., etc.—also How to Start and Operate a Successful Radio-Electronic-Service Business. 1300 pages. 706 helpful illustrations. Self-Test Review Questions make study easy. Only \$5 (\$5.50 foreign).

FOR BEGINNERS!

Sales records prove that more Radio-Electronic beginners have gotten their start from Ghirardi's 972-page RADIO PHYSICS COURSE than from any other book or course ever published. It's a complete radio course in book form—so head and shoulders above anything else that it is used as the basic text by thousands of students and by schools in 82 different countries of the world! Everything is explained as simply as A-B-C. Over 300 Pages are devoted to Basic Electricity alone. 508 illustrations help you learn fast. \$5 (\$5.50 foreign).

ELIMINATES NEEDLESS TESTING!

There's no magic about it! Just common sense! Over 400 pages of Ghirardi's 744-page RADIO TROUBLESHOOTER'S HANDBOOK contain tabulated and indexed listings of common trouble symptoms, their causes and remedies for almost every radio in use. Actually it gives specific trouble listings for over 4800 home receivers, auto radio and record changer models of 202 manufacturers! Just look up a defective radio's make and model. The HANDBOOK tells exactly what the trouble is likely to be—exactly how to fix it. 9 out of 10 jobs can be handled by this method—in $\frac{1}{2}$ the usual time BECAUSE TEDIOUS TESTING IS ELIMINATED. Over 300 more pages contain service hints, alignment data, tube information, graphs, diagrams and charts to help you fix ANY RADIO EVER MADE in far less time and at greater profit! Only \$5 complete (\$5.50 foreign). 5-DAY MONEY-BACK GUARANTEE.

... NO PREVIOUS EXPERIENCE NEEDED!

GUARANTEED
TO HELP YOU LEARN
COMPLETE BASIC
RADIO-ELECTRONICS.
... for beginners!



Let Ghirardi's TROUBLESHOOTER'S HANDBOOK save you time on common radio service jobs! Let his MODERN RADIO SERVICING train you for complete, professional electronic work. Get BOTH BIG BOOKS at special price of only \$9.50 for the two. See coupon.

MAIL ORDER rush coupon!

DEPT. RC-67, MURRAY HILL BOOKS, INC.
232 Madison Ave., New York 16, N. Y.

Enclosed find \$..... for books checked; or send C.O.D. (no foreign C.O.D.'s) for this amount plus postage. It is understood I may return books for refund within 5 days if not fully satisfied.

RADIO TROUBLESHOOTER'S HANDBOOK \$5 (\$5.50 foreign) MODERN RADIO SERVICING \$5 (\$5.50 foreign)

MONEY-SAVING COMBINATION OFFER: Both of the above big books, only \$9.50 for the two (\$10.50 foreign).

RADIO PHYSICS COURSE \$5 (\$5.50 foreign).

Name

Address

City & Zone..... State.....

HIGHBRIDGE'S BEST BUY NEW DYNAMIC TELEVISION KIT

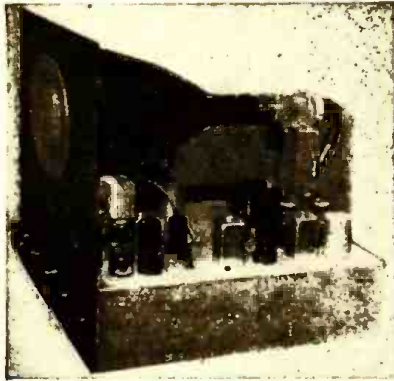

COMPLETE **\$159.50**
With Tubes—Parts—Cabinet

Exclusive Mail Distributors

Check These Outstanding Features:

- Three stages of video I.F. amplification—3.5 MC bandwidth.
- Receiver may be aligned easily without use of signal generator.
- Complete resistance and voltage analysis chart for easy trouble shooting supplied with each kit.
- If transformers are slug tuned for high gain and maximum efficiency.
- Safety interlock switch supplied with each unit.
- Simplicity of operation—only 5 controls on front panel.
- Schematic diagrams are broken down into simple circuits for ease in wiring.
- Picture is very stable—does not jump or tear out even under unusual receiving conditions.
- 4 Channels—provisions for six.
- Seventeen tubes including large picture tube.
- Picture tube is seven inches in diameter and gives a picture 26 square inches in size.
- All parts are unconditionally guaranteed to be electrically and mechanically perfect.

Set comes complete with all necessary information sheets, parts, drilled and punched chassis, beautifully finished front panel and modernistic cabinet. Hardware and other necessary items are also included. **NOTHING ELSE TO BUY.**

SONAR SOUND DETECTION UNIT

In Original Overseas Packing

Ideal for detecting underwater sounds within an area of 15 miles. Using a Rochelle salt crystal as the active unit the sound is transmitted up a 60 ft. cable. Completely enclosed in a solid rubber sheath. Originally used in harbor defense. Coupled with audio amplifier it has many valuable uses. **\$9.95**

SELECTRON SELENIUM RECTIFIERS

- 50 to 99 **.85**
- 6 to 49 **.90**
- 1 to 5 **.99**



Quotations on larger quantities furnished upon request

USEFUL FOR: ★ AC-DC Portables ★ Intercorn Power Supplies ★ Console Radios ★ Replaces 29 Types of Rect. Tubes

KS-9524—Transformer Pri. 115 V—60 cycles. Sec. #1—450 V @ 30 MA C.T. Sec. #2—6.4 V. @ 1250MA. Rectangular metal case. stud mtk. solder eyes—approx size 3 1/16 x 2 5/16 x 3/8 with standoff 4/8.

No. T2G-97. Special. **\$1.95**

I.R. #7313 Filament Trans. 115 V—50-60 cycle. Sec. #1—27KV @ 4.3 amps No. C.T. Sec. #2—6.1 V. @ 3 amp C.T. Sec. #3—6.4 V. @ 3 amp No. C.T. Sec. #4—5.1 V. @ 8 amp C.T. Sec. #5—2.6 V. @ 3.5 amps No. C.T. Rectangular metal case, solder post terminals. 3/16 on porcelain stand-off. stud mtk. size 5/8 x 4/8 x 5/8 with standoffs 6/8.

T2E-88. Special. **\$4.95**

NEW No. 631P1/SNA Glass Stronotron tubes. Each **\$3.25**
100 By-Pass Condensers. 10 Varieties. Special. **\$4.95**

High voltage transformer with Glass Standoffs. Pri. 115 V. A.C.—100 cycle—Sec. 13,500 V. Rectangular; approx. size 6 1/2 x 4 1/2 x 3/8 with standoff 7/8—13 Mills D.C.

T3F-7. Special. **\$3.95**

TUBE		
12A6	.83	6SN7 .79
6SQ7	.83	6S17 .83
6AJ5	1.25	6C4 .79
1625	.70	6BP4 .595

All Prices FOB New York City. N. Y.

**HIGHBRIDGE RADIO-TELEVISION
& APPLIANCE CO.**

343 CANAL NEW YORK 13. NEW YORK

WORLD-WIDE STATION LIST

Edited by ELMER R. FULLER

CONDITIONS here have not been very good. The same seems to be true all over, as very few stations of note were reported by our observers this past month. This year marks the beginning of the twenty-first year of broadcasting of the "Happy Station" known to many listeners as PCJ. It is located in Hilversum, Netherlands, with the programs under the direction of Edward Startz who is well known to many of you. Transmissions are directed toward the United States and Canada on Sundays and Wednesdays from 2130 to 2300 hours EST. Frequencies used are 11.730 mcs, 9.59 mcs, and 6.02 mcs. Other transmissions are heard on Sundays at 1030 to 1200 hours on 17.77 mcs, 15.22 mcs, and 6.02 mcs; and from 1600 to 1730 hours on 11.73 mcs, 9.59 mcs, and 6.02 mcs. Transmissions on Tuesdays are from 0300 to 0430 hours on 17.77 mcs, 15.22 mcs, and 6.02 mcs; and on Wednesdays from 1030 to 1200 hours on 17.77 mcs, 15.22 mcs, and 6.02 mcs; from 1600 to 1730 hours on 11.73 mcs, 9.59 mcs, and 6.02 mcs.

Many changes have been made recently in the U. S. stations' frequencies

and schedules. These will be available to you in the next issue. Our new 24-hour clock system seems to have been well received by our readers according to the letters received recently. We are glad that you like it and hope to see it used throughout the shortwave spectrum in the near future. It certainly saves a lot of confusion.

Some new equipment has been put into service here and we have a report ready for you in an early issue. A Panadaptor (manufactured by Panoramic Radio Corp.) is being used for visual reception, and our report on it will give you full dope on its operation and usefulness to the shortwave listener. Your shortwave editor would like to correspond with anyone using a Panadaptor in conjunction with their receiver. To those of you who have written about the shortwave dope card, we will have more on this matter in a few weeks, possibly by the time that you read this. Information will be sent to you soon.

(All schedules are on Eastern Standard Time)

Location	Station	Freq.	Schedule	Location	Station	Freq.	Schedule
FINLAND				Delhi	VUD7	6.100	0830 to 0915
Lahiti	OIX2	9.500	1100 to 1600	Delhi	VUD8	7.270	0600 to 0700; 1115 to 1315; 1830 to 1915;
Lahiti	OIX5	17.800	0130 to 0200; 0500 to 0545; 0800 to 1700				2100 to 2200
FRANCE				Delhi	VUD3	7.200	2040 to 2245
Paris		11.840	0000 to 0045; 0100 to 0145; 0545 to 0615; 1045 to 1130; 1315 to 1730; 1830 to 2345	Delhi	VUD4	9.390	0300 to 0400; 0430 to 0515; 0800 to 1220
Paris		15.350	0700 to 0900	Delhi	VUD4	9.670	0000 to 0130; 0200 to 0400; 0430 to 0515; 0730 to 0745; 0800 to 0830; 0845 to 1230
Paris		17.760	0700 to 0900; 1100 to 1230	Delhi	VUD3	15.290	0130 to 0145; 0300 to 0400; 0445 to 0815; 2245 to 0030
FRENCH EQUATORIAL AFRICA				Delhi	VUD10	17.830	0400 to 0430; 0445 to 0700
Brazzaville	FZI	6.020	1600 to 1845; 0000 to 0130	IRAN			
Brazzaville	FZI	9.440	0000 to 0130; 1100 to 2020	Teheran	EQB	6.150	1000 to 1415; 2230 to 2400
Brazzaville	FZI	11.970	0445 to 0500; 0930 to 1030; 1100 to 2020; 0000 to 0230	Teheran	EQC	9.680	1200 to 1430
Brazzaville	FZI	15.500	0445 to 0800; 0930 to 1030	JAMAICA			
Brazzaville	FZI	17.530	0000 to 0130; 0445 to 0745; 1100 to 1700	Kingston	ZQ1	4.700	1630 to 1830
FRENCH WEST AFRICA				JAPAN			
Dakar	FGY	7.210		Tokyo	JVT	3.075	0400 to 0900.
GERMANY				Tokyo	JVW	7.200	Home Service, 8 pm to 8:30 am
Berlin	DTYC	6.070	0000 to 0345	Tokyo	JLG	7.280	Home Service, 0200 to 0800
Munich	AFN	5.300	0000 to 0930	Tokyo	JL2	9.510	0300 to 0830
Munich	AFN	8.560	0400 to 1200	Tokyo	JLU2	9.520	0600 to 1200
GOLD COAST				Tokyo	JZK	15.160	1730 to 1815
Accra	ZOY	7.290	1045 to 1300	Tokyo	JTL3	15.220	1800 to 0230
GREECE				KENYA			
Athens	SVM	7.290	1420 to 1530	Nairobi	VQ7L0	4.930	1100 to 1400
Athens	SVM	9.830	1300 to 1800	Nairobi	VQ7L0	10.730	0500 to 0600; 0830 to 0915; 0945 to 1100
GUADALOUPE							
Point-a-Pitre	FGBH	5.930	1700 to 1900				
Point-a-Pitre	KUSQ	7.640	0400 to 1200				
GUAM	KUSQ	9.830	2300 to 0100; 0530 to 0700; 1100 to 1330; 1400 to 1545				
GUAM	KUSQ						
GUATEMALA							
Guatemala City	TGWB	6.530	0800 to 1200; 1830 to 0100				
Guatemala City	TG2	6.620	1800 to 2300				
Guatemala City	TGWA	15.170	1200 to 2000				
HAITI							
Port-au-Prince	HM2S	5.950	0600 to 0815; 1100 to 1300; 1730 to 2130				
Port-au-Prince	HHCM	6.160	0500 to 0830; 1100 to 1400; 1700 to 2145				
HAWAII							
Honolulu	KRHO	9.650	0400 to 1100				
Honolulu	KRHO	17.800	Philippine beam, 0400 to 1130				
HONDURAS							
La Corba	HRD2	6.230	1200 to 1400; 1900 to 2300				
San Pedro		6.360	1100 to 1415; 1800 to 2255				
Sula	HRP1						
Taguigalpa	HRN	5.870	0800 to 1000; 1300 to 1500; 1800 to 2300				
ICELAND							
Reykjavik	TFJ	12.260	Sundays, 0900 to 0930				
INDIA							
Delhi	VUD3	3.340	1200 to 1245				



Suggested by Frank Beaven

"Ah, Ah, Don't Touch That Dial!"

Location	Station	Freq.	Schedule
LEBANON			
Beirut	FXE	8.030	0015 to 0115; 0525 to 0630; 1000 to 1600
LUXEMBOURG			
		6.090	1430 to 1700
MALAYA			
Singapore		4.780	1730 to 2230; 2330 to 0130
Singapore		6.770	0345 to 0935
Singapore		7.220	2330 to 0130
Singapore		9.550	0315 to 0515; 0530 to 1100
MARTINIQUE			
Ft de France		9.700	0900 to 1245; 1600 to 1610; 1730 to 2030
MEXICO			
Guadalajara	XEJG	4.890	2200 to 2400
Mexico City	XEUW	6.050	0700 to 0100
Mexico City	XEUZ	6.130	1500 to 0030
Mexico City	XEWV	9.500	0800 to 0200
Mexico City	XETT	9.550	0700 to 0100
Mexico City	XEYU	9.600	Sked unknown
Mexico City	XEQQ	9.680	0700 to 0045
Mexico City	XETW	6.040	0745 to 0045
MOROCCO			
Rabat	CNR3	9.080	0100 to 0330; 1300 to 1700
MOZAMBIQUE			
Lourenco Marques	CR7B0	4.920	Daily, 1330 to 1600; Sundays, 1000 to 1400
NETHERLANDS			
Hilversum	PCJ	6.020	0300 to 0430; 1030 to 1200; 1600 to 1730; 2130 to 2300
Hilversum		9.59	2130 to 2300; 1600 to 1730; 2130 to 2300
Hilversum		11.73	1600 to 1730; 2130 to 2300
Hilversum		15.22	0300 to 0430; 1030 to 1200
Hilversum		17.77	0300 to 0430; 1030 to 1200; 2130 to 2300
NETHERLAND INDIES			
Bandoeng		4.790	0730 to 0900
Bandoeng	PMA	4.780	Sked unknown
Batavia	PMC	18.135	2330 to 0930
NEW CALEDONIA			
Noumea	FK8AA	6.200	0200 to 0400; 1900 to 2000
NEWFOUNDLAND			
St. Johns	VONH	5.970	0900 to 1400; 1500 to 2200
NEW ZEALAND			
Wellington	ZLT7	6.710	0415 to 0450
NICARAGUA			
Managua	YNDS	6.760	0800 to 1000; 1700 to 2330
Managua	YNQW	6.850	0800 to 2400
Managua	YNQW	6.910	schedule unknown
NOVA SCOTIA			
Halifax	CHNX	6.130	0700 to 2300
Sydney	CJCX	6.010	0530 to 2200
PALESTINE			
Jerusalem	JCKW	7.220	2330 to 0130
PANAMA			
Colon	HP5K	6.000	0700 to 1300; 1900 to 2300
Panama City	HP5B	6.030	1800 to 2300
Panama City	HP5H	6.120	0700 to 2300
Panama City	HP5A	11.700	0700 to 2300
Panama City	HP5G	11.780	0745 to 1000; 1200 to 2230
PERU			
Lima	DAX4Z	5.890	1630 to 2330
Lima	OAX4V	5.910	1800 to 2400
Lima	OAX1B	5.530	1800 to 2330
POLAND			
Warsaw		6.100	1330 to 2100
PORTUGAL			
Lisbon	CS2WD	6.150	1430 to 1900
Lisbon	CSX	6.370	1330 to 1900
Lisbon	CSW7	9.730	1900 to 2000
Lisbon	CSW6	11.040	0900 to 1130; 1230 to 1500; 1600 to 1800
Lisbon	CSX	11.990	0800 to 1000
PORTUGUESE GUINEA			
Bissau		7.100	1600 to 1730
SALVADOR			
San Salvador	YSN	7.310	1300 to 1500; 1900 to 2300
SOUTH AFRICA			
Capetown	ZRK	5.880	2345 to 0130; 1000 to 1600
Capetown	ZRL	9.610	0300 to 0700; 0900 to 1030
Johannesburg	ZRH	6.010	2345 to 0130; 0900 to 1100
Johannesburg	ZRG	9.520	0200 to 0700
Johannesburg	ZTJ	9.900	0315 to 0715
SOUTHERN RHODESIA			
Lusaka	ZQP	8.910	2230 to 1800
SPAIN			
Alicante		7.950	0730 to 0930; 1530 to 1800
Madrid	EAQ	9.370	1500 to 1700; 1830 to 2100
SPANISH MOROCCO			
Tetuan		6.060	0230 to 0300; 1330 to 1830
SURINAME			
Paramaribo	PZHS	5.840	1800 to 2045
SWEDEN			
Stockholm	SBU	9.530	0130 to 0145; 1330 to 1700; 2000 to 2100
Stockholm	SDB2	10.780	1100 to 1720
Stockholm	SBP	11.700	2000 to 2100
Stockholm	SBT	15.150	0130 to 0215; 0600 to 0700; 1000 to 1315
SWITZERLAND			
Berne	HER3	6.160	0020 to 0120; 0245 to 0700; 1200 to 1700
Berne	HE12	6.340	
Berne	HEK3	7.380	1000 to 1045; 1510 to 1530
Berne	HEF4	9.180	
Berne	HE15	11.710	Tuesdays and Fridays, 1000 to 1130; Saturdays, 1550 to 1625
Berne	HEK4	11.960	1645 to 1715 except Saturdays
Berne	HER6	15.310	Saturdays, 1000 to 1200
Berne	HEB	9.340	1300 to 1500
TAHITI			
Papeete	F08AA	6.980	Tuesdays and Fridays, 2200 to 2400
TURKEY			
Ankara	TAP	9.460	1000 to 1615
Ankara	TAQ	15.190	0000 to 0200; 0415 to 0730

Musical Distinction
WITH
ABSOLUTE FIDELITY
AMPLIFICATION
DESIGNED BY A. C. SHANEY

A new amplifier development now available (clearly identify all the instruments in a full orchestra). After 20 years of audio research and development, we can now place in your hands a new means to make the most fascinating, uplifting, and enjoyable journey into the realm of perfect sound reproduction—through the medium of the most satisfying musical amplifier the world has ever known.

If you are one of those discriminating persons for whom anything less than the best is a disappointment, you are one for whom the ACA-100DC Amplifier was designed. Send for literature.

AMPLIFIER CORP. of AMERICA
398 BROADWAY, NEW YORK 13, N. Y.
Send 3c stamp for A. C. Shaney's new booklet "20 STEPS TO PERFECT AMPLIFICATION"
A. C. SHANEY'S FM-AM AMPLIFIER MANUAL IS STILL AVAILABLE AT 25c

NUMBERS 2 and 3 OF THE

WALSCO Hit Parade

IT'S HERE THE NEW, COLORFUL EASY TO APPLY



FELT FLOCK FINISH

COMPLETE FELT FLOCK SPRAY OUTFIT

Now you can do your own finishing of: Radio cabinets and speaker grilles, phonograph turntables and record cases, novelties, crafts, hobbies and numerous other items

10 brilliant colors available. The kit (as pictured) contains patented WALSCO Felt Flock Spray Gun, together with necessary materials, such as undercoats, ivory and brown felt flocks, brush, instructions, etc.,
CATALOG NO. K-50—List Price \$10.75

Write for full information on these items. Dept. 63

WALSCO products
Help The Radio Man
WALTER L. SCHOTT CO. BEVERLY HILLS, CALIF. CHICAGO 5, ILL.

RADIO MEN
Write for Bargain Catalog of Radio Parts
BUYERS' SYNDICATE
786 Carew St. Springfield, Mass.

\$3.00 FOR CARTOON IDEAS
RADIO-CRAFT prints several radio cartoons every month. Readers are invited to contribute humorous radio ideas which can be used in cartoon form. It is not necessary that you draw a sketch, unless you wish.
IDEAS NOT WANTED:
No electrical or radio definitions wanted. Some of these were published in the past, but the subject is about exhausted.
Payment is made on publication.
Address **RADIO CARTOONS, RADIO-CRAFT, 25 West Broadway, New York 7, N. Y.**

WALSCO STAPLE DRIVER

- Pays for itself on the first job
- A sensational tool for installing wires and cables, that saves time and money.
- Used by Radio, Public address and Intercom Technicians.
- Staples into corners and other inaccessible places.
- Staples on hard surfaces such as plaster, hardwood, etc.
- Can be loaded in 10 seconds.

The WalSCO Staple Driver is a real time and trouble saving tool for the radioman. Also extremely useful for general stapling. This device automatically positions the staple after which it is driven to a pre-adjusted depth with one or two strokes of the palm of the hand. A small trigger controls the feeding mechanism. Wires and cables up to 1/4" in diameter can be quickly installed with the WalSCO Staple driver.
Price \$4.95 Dealers Net (including box of staples)

NEWS ABOUT
THE LATEST IN RADIO PARTS—EQUIPMENT—ELECTRICAL DEVICES—brought to you in our monthly bulletins. ABSOLUTELY FREE! No obligation.
WRITE TO
MANUFACTURING DIVISION
HERBACH & RADEMAN, INC.
ELECTRONICS SPECIALISTS
522 MARKET ST., PHILA. 6, PA. • DEPT. B
Radio production for the first quarter of 1947 totalled 4,231, 415 receivers.

FREE!



MAIL
COUPON
TODAY

25th

ANNIVERSARY

LAFAYETTE'S BIG NEW CATALOG

RADIO & ELECTRONIC EQUIPMENT

SEND NOW for your free copy of this giant-size, 144-page catalog which offers you America's latest, largest line of top-quality ham gear, parts, communication equipment, tubes, tools, test equipment, amateur kits and accessories. Page after page of post war radio developments—plus a special bargain section that lists surplus and standard-make radio and television parts at famous Lafayette economy.

SUPREME PANEL METER BARGAINS

3" SQUARE CASE
PS 306 0 to 10 MA DC. Supreme No. 3111
PS 308 0 to 50 MA DC. " " 3115
PS 323 0 to 300 MA DC. " " 3120
PS 315 0 to 10 V.D.C. " " 3135
\$4.53 EACH
PS 305 0 to 1 MA DC. Supreme No. 3107
\$4.85
4" SQUARE CASE
PS 328 0 to 25 MA DC. Supreme No. 4114
PS 329 0 to 50 MA DC. " " 4115
\$5.15 EACH

LAFAYETTE RADIO

RADIO WIRE TELEVISION, INC.

NEW YORK 13, 100 Sixth Ave.

BOSTON 10, 110 Federal St.

NEWARK 2, 24 Central Ave.

RUSH
COUPON
TODAY

LAFAYETTE RADIO, Dept. JF-7
100 Sixth Ave., New York 13, N. Y.

RUSH my free copy of new Lafayette
Catalog.
Enter my order for Items No.
Money Order Send C.O.D.

Name.....
Address.....
City..... Zone..... State.....

PASTE COUPON
ON PENNY POSTCARD

NOISE ELIMINATION

(Continued from page 29)

provided he is tactfully assured that his sign will work as it did before.

Household equipment interference

If a refrigerator is causing the noise, putting the radio on a different outlet may help, but more often the refrigerator is in need of repair. The brushes in the motor may spark excessively and require replacement; the commutator may need cleaning or turning down. The belt may need replacing. If in doubt, try to have a refrigerator expert look it over and make any necessary repairs. If it still interferes, the noise can be further cut down by putting a filter similar to that in Fig. 1 on the refrigerator. However, in many cases an ordinary line noise filter can be used without difficulty and with completely satisfactory results.

If the noise is being produced by an electric razor, putting a filter at the razor outlet, as shown in Fig. 2, may prove helpful. The setscrew which holds the wall plate of the regular outlet to the box may be loosened slightly. Then the wire from the ground post of the

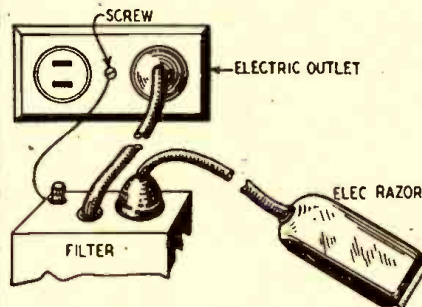

Fig. 2—Put line filters near the receptacle.

filter is twisted under the head of the screw, in a clockwise direction, so that tightening the screw will make the wire fit tight. The razor itself is plugged into the filter box which may contain a couple of by-pass condensers and, in some cases, series chokes, depending on the filter purchased.

A listening test should be made. If the filter does not cut out the noise, try using it at the radio instead of at the razor outlet. Be sure wherever possible to use different outlets for the razor and radio.

Razor interference is often terrific. In some cases there will be nothing to do but buy a frequency-modulation radio or turn the regular radio off while the razor is being used.

Keeping the antenna of the set away from power wiring and using a doublet lead-in will help in minimizing interference.

Work at the radio

Realigning the radio and making every effort to get it selective will help in cutting down noise. With sharp selectivity, a certain amount of side-band cutting will be noticed, reducing the total amount of noise output of the detector, since smaller side bands mean

"GLOBE"-SMASHING SPECIALS

"GLOBE" RADIO TUBES

OUR OWN BRAND

100% Perfect New and Fully Guaranteed,
in Cartons

OZ4	.88	7B7	.72	35Z5	.48
1A7	.72	7C5	.72	36	.55
1A5	.72	7B8	.72	42	.48
1U5	.88	7H7	1.08	43	.59
1H5	.59	7Y4	.72	45	.44
1LA6	1.53	12A8	.55	47	.59
1LB4	1.53	12J7	.59	50A5	1.08
1LC6	1.53	12Q7	.49	50L6	.59
1LE3	1.53	12SA7	.55	50B5	1.28
1LH4	1.28	12SA7 GT	.72	50Y6	.59
1LN5	1.28	12SK7	.72	57	.49
1N5	.72	12SQ7	.59	70L7	1.56
3Q5	1.04	14A7	1.08	75	.48
5Y3	.55	14B6	.88	78	.49
6A7	.55	14Q7	.88	80	.39
6A8	.55	24A	.49	84	.59
6C6	.55	25L6	.59	85	.49
6D6	.55	25Z5	.55	117M7	1.53
6K5	.59	25Z6	.72	117L7	1.53
6K7	.59	27	.39	117P7	1.53
6SQ7	.59	35	.55	117N7	1.53
6X5	.55	35A5	.83	117Z3	.88
7A4	.72	35L6	.72	117Z8	.88
7A8	.72	35W4	.59	117Z6	1.04
7B6	.72	35Z3	.72	XXL	.88

Minimum Order: 10 Tubes
Orders of 100 Tubes or more—10% discount
on above prices

We carry a complete Line of Tubes

TRANSMITTING and SPECIAL PURPOSE TUBES. "Jan" Inspected, Fully Guaranteed

807	.98	2A4G	1.25	9004	.98
2050	.98	3BP1	2.75	VR 105/30	.89
2051	.98	RK34	1.75	9002	.98
9005	.98	866A	.89	884	.89
9006	.98	717A	.89	885	.89
829B	2.75	9001	.98	885	.89
872A	1.98	9003	.98	1645	.98

- Acorn Tubes: Nos. 954 to 957—49c
- Hearing Aid Tubes: Nos. 501AX to 509AX—49c
- Subminiature Proximity Radio Tubes, used in Radar Timing Devices: (DIODE. 6.3 Filament)—69c

POPULAR BRAND CONDENSERS

... First Quality — Fresh Stock

ELECTROLYTICS	BY PASS	
	at	at
20/20 @ 150	39c	Mfd. 400 Volts 600 Volts
20 @ 150	25c	
10 @ 450	27c	.001 — 9c
16 @ 450	45c	.005 — 9c
20 @ 450	52c	.01 9c 9c
10 @ 25	18c	.03 9c 9c
25 @ 25	19c	.05 10c 10c
50/30 @ 150	49c	.25 12c 12c
		14c 14c

Minimum Condenser Order: 10 Condensers

VOLUME CONTROLS

500,000 OHMS, S.P.S.T. Switch. 2" Shaft — 47c
500,000 OHMS, D.P.S.T. Switch. 2" Shaft — 58c
2-Tube Phono Oscillator—Uses 35W4 and 50B5—
Packs terrific wallop 4.25
5" Alnico #5 P.M. Speaker (1 oz. Magnet) 1.45
Output Transformer for 50L6 69c
6 ft. Approved AC Line Cord 25c

THIS MONTH'S SPECIALS

6AK5 TUBES

New & Guaranteed,
in sealed Cartons **89c**

- 20% deposit required with all orders
- We ship your order the same day we receive it.
- Money-back guarantee on all items.
- Write for our free catalog and order blanks.

GLOBE DISTRIBUTORS

72 Harvard St.
Boston 24, Mass.

less audio output. There may be some sacrifice of fidelity, especially in heavily built-up sections of cities, but often the listener is willing to hear fewer high notes if only the main portion of the audio spectrum is not too noisy.

Usually, sets with a stage of r.f. before the first detector will outperform sets without the r.f. stage. In some cases it may be wise to recommend to the customer that the set be traded in for a larger one which does have r.f. This has been found excellent "repair" practice in many stubborn cases of noise.

A good antenna is important but not the whole story by any means. In the shadow of Brooklyn Bridge or any of the other big steel bridges reception may be very poor. On one side of the Manhattan skyline, running north and south, reception from certain stations may be good, but on the other side reception from the same stations may be too weak. If the local noise level is high, the weak signal cannot be separated

easily from the noise, and whatever separation is gained is due to the selectivity of the receiver and to such other things as inherent low noise in the set itself.

Line noise filters at the radio will often eliminate noise due to elevators. It is usually impractical to filter the elevator itself.

A simple filter the radioman can make and use is shown in Fig. 3. The 2 coils

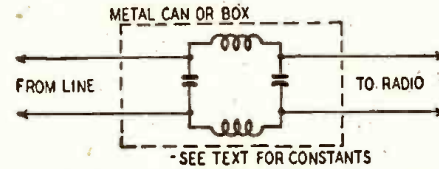

Fig. 3—A more effective type of line filter.

are ordinary rolls of bell wire, used just as purchased. The condensers should be of the metal-cased type and may range from 0.5 to 2 μ f. It is a good idea for the serviceman to construct 3 filters (one with 0.5- μ f condensers, one with 0.1- μ f condensers, and the third with 1.0 μ f condensers) and to use the one which is best for the given job. To provide shielding the coils should be put in a metal can about the size of a coffee can or slightly smaller. They can be inserted between the line and either the radio or the interfering device.

In some cases, where the radio is several floors above the street level, it may be found that less noise will be picked up if the ground wire is left off the set than if it is attached. The reason for this is that the impedance between the ground terminal and the actual earth ground may be appreciable for a long stretch of pipe; noise currents flowing in that impedance set up a noise voltage which acts in series with the input circuit of the radio.

Keeping the antenna of the set away from overhead power wiring is important from the standpoint of minimizing noise. The higher the antenna, the better! Distance from surface or elevated electric railway lines is also important. Very often it will pay to use a longer doublet lead-in and to keep the flat top farther away from the elevated line or overhead power wires, and particularly from other antennas on the same roof. In apartment buildings, this is often difficult, but all possible efforts should be made. Keeping the flat top away from the elevator housing on the roof is desirable also, since the elevator and everything connected with it is noisy.

The importance of a good antenna job cannot be stressed too much. In some respects, this work is pure labor and not very technical, but it's a very important part of servicing and not to be shirked. At least half the noise jobs can be solved simply by installing a good outside aerial. The change in signal-to-noise ratio is usually such that the offending interference hardly can be heard at the new and lower volume control setting required to bring in programs at a satisfactory level. This is true even in the case of FM radios which are not as susceptible to noise as AM sets, but require outside antennas for best reception.

OPPORTUNITY AD-LETS

Advertisements in this section cost 20 cents a word for each insertion. Name, address and initials must be included at the above rate. Cash should accompany all classified advertisements unless placed by an accredited advertising agency. No advertisement for less than ten words accepted. Ten percent discount six issues, twenty percent for twelve issues. Objectionable or misleading advertisements not accepted. Advertisements for July, 1947. Issue must reach us not later than May 28, 1947. Radio-Craft • 25 W. B'way • New York 7, N. Y.

CORRESPONDENCE COURSES AND SELF-INSTRUCTION books widely used. Sold Binded. Excluded. All subjects. Satisfaction guaranteed. Cash paid for used courses. Complete information and 100-page illustrated Bargain catalog Free! Write—Nelson Co., Dept. 39, Chicago 5, Ill.

MAGAZINES (BACK DATED)—FOREIGN, DOMESTIC, arts, books, booklets, subscriptions, pin-ups, etc. Catalog 10c (refund). Cicerone's, 863 First Ave., New York 17, N. Y.

FREE WHOLESALE BULLETIN, TUBES, PARTS. Bargain prices. Henshaw Radio Supply, 3313 Delavan City, Kansas City, Kansas.

AMATEUR RADIO LICENSES, COMPLETE CODE and theory for passing amateur radio examinations. Home study and resident courses. American Radio Institute, 101 West 63rd Street, New York City. See our ad on page 80.

WE REPAIR ALL TYPES OF ELECTRICAL INSTRUMENTS, tube checkers, and analyzers. Hazleton Instrument Co. (Electric Meter Laboratory), 140 Liberty Street, New York, N. Y. Telephone—BARCLAY 7-4239.

EXPORT AND SALES AGENT SEEKS LINES FOR export trade. P. O. Box, 1320, San Francisco.

DON'T FAIL YOUR AMATEUR EXAMINATION!!! Pre-examination test based on actual FCC written examinations \$2. E. E. Hand, 3044 Via Campo, Montebello, Calif.

FRANCHISES OPEN FOR EXPERIENCED TELEVISION SERVICE MEN. Manufacturers of nationally distributed television kit wishes to line up service centers in various television areas. Applicants must have extensive television service experience and suitable equipment for lining up television receivers. Those selected will receive servicing franchise and will be advertised as a service center for servicing this kit. Transvision, Inc., Dept. RC, 385 North Ave., New Rochelle, N. Y.

TELEVISION—AVAILABLE NEW "SECOND EDITION"—Design & Construction of a 5 or 7" Television Receiver and "Design & Construction of a Visual Alignment Sweep Signal Generator" at \$1.75 each booklet. Immediate delivery special television parts. IF and RF coil kits, transformers, cathode ray tubes, Punched "Vision" chassis, shields. Write for price list. Special Television Receiver Kit #590A including complete set of 10 matched coils for 5 or 7" receiver ships complete \$4.95 each. Vision Research Laboratories, P. O. Box 52, Kew Gardens 15, New York.

UNIVERSAL'S "MIDGET" POCKET TOOLS, DANDY 12-Pc. Set: 10 midget Open End Wrenches 3/16" to 7/16". This and SHD 15% & 75% Unirip Midget Filers, and Screwdriver, \$12.95. Remit Today. New catalog Free 1-1 UNIVERSAL TOOL COMPANY HAS IT. 1527 Grand B C, Kansas City 8, Missouri.

FREE ILLUSTRATED CATALOG OF RADIO-ELECTRONICS books. Servicing, home study, UHF, radio math, electricity, operating, television, etc. D. B. Neuhues Publishing, Dept. C6, 300 Pacific Street, Brooklyn 2, N. Y.

BUILD RADIO, PHONOGRAPH, COMBINATIONS. complete kits: catalog. Radion, 6922C, 21st Ave., Brooklyn 4, N. Y.

WRITE DEPT RC 20 FOR OUR LATEST FREE BARGAIN list of Radio and Electronic parts. I. C. Radio Parts and Dist. Co., 733 Central Ave., Kansas City 6, Kansas.

Thousands of Satisfied Users!

TRANSVISION

TELEVISION KIT... A HIGH QUALITY TELEVISION RECEIVER

ready for Easy, Rapid Assembly

Features the Brilliant LECTROVISION Picture Tube!

ENGINEERED BY TELEVISION SPECIALISTS



Easy-to-Assemble: No Knowledge of television required. COMPLETE easy-to-follow INSTRUCTION SHEET gives you all the knowledge you need.

This Kit INCLUDES SOUND, all component parts, and the following:—

Specialty designed Television Antenna . . . A \$30.00 Brilliant Lectrovision seven-inch Picture Tube, plus ALL other tubes . . . Pre-tuned R-F unit . . . Finished front panel . . . All solder, wire and 60 ft. of low loss lead-in cable.

Operates on 110V.; 50-60 cycles A.C. Price: complete with ALL tubes, \$159.50 (fair traded)

IMMEDIATE DELIVERY!

We believe that the comparative quality of this set is superior to other available sets. It has been acclaimed by major television schools.



CABINET FOR TRANSVISION Television Kit

Made of selected grain wood, with beautiful hand-rubbed walnut finish. Labeled knobs. Overall size: 17 1/2" deep; 19 1/2" wide; 15 3/4" high. Price: \$29.95

DEALERS! Cash in on this Kit! Ideal for making your own Custom-Built Television Receiver. See your local distributor, or for further information write to:

TRANSVISION, INC. Dept. RC
385 North Ave. New Rochelle, N. Y.

In New Jersey...
...it's VARIETY

SENSATIONALLY NEW

TRANSVISION

TELEVISION KIT



Ready for easy rapid assembly. No knowledge of television required. Complete easy-to-follow instruction sheet gives you all the knowledge you need.

Reception is clear and sharp... comparable to a moving picture.

All necessary components are included. Nothing is required except a screw driver, cutting pliers and a soldering iron. Only the highest quality standard parts are used—the list price value of these parts alone is more than **\$159.50**
 \$300. 110 volts, 60 cycles A.C.

ASTATIC PHONO PICKUPS

Complete with L70 crystal & Hardware **\$1.98**

I.F. INPUT & OUTPUT TRANSFORMERS

1 1/4 x 1 1/4" x 2 1/2", 466 kc. **.59 ea.**
 10 for \$5.40

PHONO KIT

(Contains motor, turntable, pickup arm complete) **\$5.95**

PLASTIC KNOBS

(White, Red, Red Mahogany and Tan.) (In lots of 100. \$4.25.) Slip-on type 1 1/2 in. with 1/4 in. shaft **.05 ea.**

ANTENNA LOOPS

8x5 3/4 Primary and Secondary (10 for \$3.67) **.39 ea.**

GUARANTEED VOLUME CONTROLS

Less Switch.....48c 10 for \$4.45
 With Switch.....59c 10 for 5.45
 500,000, 100,000, 25,000 ohms; 1/4 meg, 1 meg, 2 megs.

FEDERAL SELENIUM RECTIFIER

6 or more.....**.99 ea.**
 Less than 6.....**\$1.09 ea.**

RESISTOR CABINETS

All wood construction, 6 drawers, 24 compartments **\$3.89**
 Complete with 100 assorted 1/2 w and 1 w resistors **\$7.95**

Bargain! Guaranteed!

100 Assorted Bypass Condensers 600V
 Value.....**\$11.00**

Special \$6.95

SUPERIOR Model

670—Super-Meter

A Combination Volt-Ohm Milliammeter plus Capacity Reactance Inductance and Decibel Measurements.

Complete with test leads and instructions **\$28.40**



Write Dept. C-6. 20% Deposit with order required. Please add sufficient postage. Excess will be refunded.

Variety ELECTRIC CO., Inc.
 601 Broad St., Newark 2, N. J.

A SMALL RECORDING STUDIO

(Continued from page 32)

sirable to cut a groove which matches this radius as nearly as possible. It is advisable not to cut too deep a groove, which would result in distortion and a loss in high-frequency response. It is wise also to determine the maximum level of signal which can be fed to the head with a given depth of cut. Otherwise, over-cutting, which will result in the grooves running into each other, will take place. This can be seen with a magnifying glass. If the grooves come too close together when cutting, an echo will be noticed when the disc is played back.

There will be a difference in depth of cut, with a particular adjustment of the cutting head, when changing from 78 r.p.m. to 33 1/3 r.p.m. A satisfactory compromise adjustment can be made if it is necessary to change speed frequently. The highest quality recording, however, necessitates individual depth-of-cut adjustment for each speed.

It is wise to check the depth of cut frequently, as even the best needle wears. As the point becomes dull it requires more pressure to cut properly. The frequency response of a recorder is a function of needle sharpness. This is particularly true when recording the higher frequencies at 33 1/3 r.p.m. For best results, the over-all response of the system should be checked frequently by cutting a variable-frequency test record (introducing sufficient compensation electrically to offset the effects of recording-blank hardness, needle sharpness, depth of cut, etc.) and observing the light pattern. All the items above can cause a high-frequency loss.

Speed considerations

When recording at 33 1/3 r.p.m., it is conventional to record at a slightly low-

er level, particularly near the center of the disc. It is not considered good practice to record any closer than 4 inches to the center of a record at this speed. Below a 6-inch radius there will be a noticeable reduction in the higher frequencies. This can be offset in part by boosting the higher frequencies smoothly as the diameter of the uncut portion of the disc increases. On some recorders this is done automatically as the carriage travels across the disc.

It is not considered good practice to record at 78 r.p.m. on the rim of a 16-inch disc, as the speed of the disc past the cutting stylus is too high for reasonable stylus life. To obtain a maximum of fidelity with good economy when using 16-inch discs, a musical selection can be recorded at 33 1/3 r.p.m. starting at the outside of the disc. A second selection then may be recorded at 78 r.p.m. This will yield a recording time of approximately 6 minutes without serious reduction in the high-frequency response of the resultant recordings.

It is poor economy to use inferior discs. One ruined sapphire will more than offset the saving effected by many "inexpensive" discs, which are not coated as evenly nor as thickly as a first-quality disc, and once the sapphire point hits the base material it is ruined. The material on the disc also may contain grit or hard spots, which result in a high noise level. Old dry blanks have a high inherent noise level, and cause the cutting stylus to wear rapidly. The blanks should not be stored in a too-dry place.

The recordist will encounter a multitude of special problems. These will be presented in itemized form, with their causes and remedies, in the next and concluding article of this series.

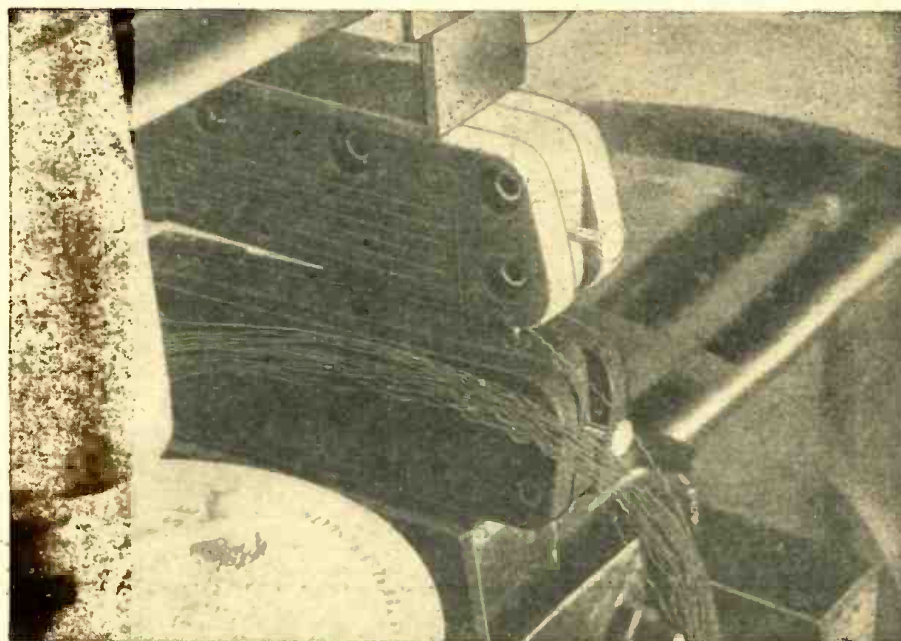

Photo D—How the chip is thrown when recorder is working properly.

NEW SUBMINIATURE PRINTED CIRCUITS

(Continued from page 25)

effective resistive and conductive paints are used on the steatite plates, inasmuch as they can be fired on at temperatures ranging from 150 to 800 degrees Centigrade.

Absolute cleanliness is necessary if the paints are to adhere. The third unit of Photo B was made by first wrapping a stencil of the coil pattern around the tube, using masking tape. The glass

applied to the etched surface and allowed to dry in air.

Range and operation

Subminiature tubes will deliver 50 milliwatts of power or more to an antenna. Although receivers are available that provide satisfactory reception on field strengths of 1 microvolt per meter, it is more practical to assume that

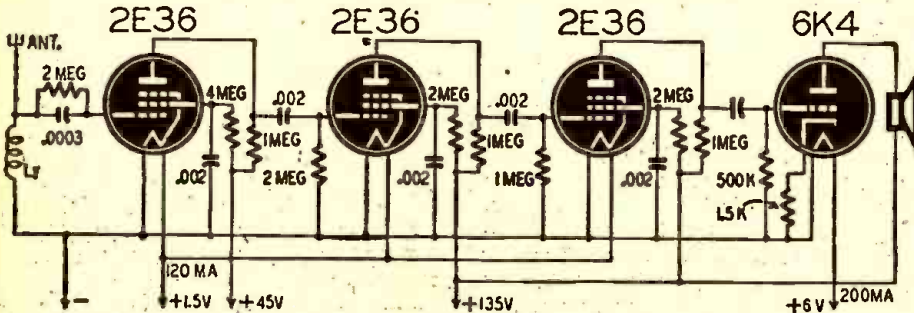

Fig. 3—Hookup of the 4-tube printed receiver does not differ from standard circuits.

envelope was then etched in fumes of hydrofluoric acid (sandblasting could have been employed) which roughens the surface and allows excellent adhesion of the paint to the envelope. After etching, the hydrofluoric acid was neutralized with strong caustic soda solution, and the envelope washed thoroughly with soap and water and rinsed in distilled water. The conducting paint was

miniature receivers will require field strengths of the order of 100 microvolts per meter for satisfactory reception. For a transmitter power of 50 milliwatts and a 100-microvolt receiver theoretical calculations yield a distance of transmission of 9.8 miles.

The ideal assumptions made in deriving formulas for distance are hardly realized in practice, particularly if one uses an antenna of convenient size and shape. For a personal radiotelephone (or transceiver) a single short telescoping antenna is preferred if any is used at all. Coupling to and radiation from the antenna unavoidably will be far from optimum. If used in a building or on a street, absorption and reflection from the walls of the buildings takes place. These and other factors make the distance of operation a matter which must be determined experimentally.

The personal radiotelephones shown in Photo B have been used successfully in various tests at the Bureau of Standards. Excellent communication was obtained with a standard transceiver located in one of the rooms of a modern four-story laboratory and a subminiature transmitter operated from all other parts of the laboratory as well as from the grounds a half a mile away. Clear reception was also possible with the transmitter located in a modern metal-roofed automobile (door closed) six blocks from the transceiver, even though many buildings prevented a clear line-of-sight transmission. A light antenna consisting of a thin rigid wire 18 inches long was employed in these tests.

While miniaturization is a feature which has attracted the greatest attention in the printing of electronic circuits, there is another feature of equal or greater importance. The process makes it possible to effect economies in production not possible in present assembly-line methods. A single operator can turn out thousands of printed electronic plates

(Continued on page 70)

FREE! Send for it NOW!

ALLIED'S 164-PAGE RADIO CATALOG



RADIO'S MOST COMPLETE BUYING GUIDE!

LARGEST STOCKS

SPEEDY, EXPERT SERVICE!

Send for your FREE copy of the most complete Buying Guide for Everything in Radio. Features thousands of radio and electronic parts, latest home radios, sound systems, amateur gear, builders' kits, servicemen's equipment, tools, books—world's largest stocks of quality equipment—all at lowest prices! Expert help; fastest service!



More than 10,000 items—Complete lines of all leading makes. Largest stocks of hard-to-get parts. Lowest money-saving prices. Get everything you need in Radio from ALLIED!



Public Address—entirely new line—new styling, new design features. Packaged Ready-to-Use Sound Systems; everything in amplifiers, speakers, mikes, intercom and recording.



Amateur Gear—immediate delivery on latest communications receivers. Time Payment plan; trade-ins accepted. Headquarters for all ham and experimenters' needs.



Handy Radio Books

Radio Formulas and Data Dictionary of Radio Terms

Radio Circuit Handbook

Radio Builder's Handbook

Simplified Radio Servicing

Radio Data Handbook

ALL SIX BOOKS No. 37-799 . . . \$1.00

Parallel Resistance and Series Capacitance Calculator. No. 37-960 . . . 25c

R-F Resonance and Coil Winding Calculator. No. 37-965 . . . 25c

ALLIED RADIO

ALLIED RADIO CORP.

633 W. Jackson Blvd., Dept. 2-F-7 Chicago 7, Ill.

Send FREE Radio Catalog

Send 6 Books No. 37-799 } \$..... enclosed

Send Calculator No. 37-960

Send Calculator No. 37-965

Name.....

Address.....

City.....Zone.....State.....

GE Spray Kit Lite-Koat Carbon-X Ne-O-Lite Tester

G-C LITE-KOAT KIT
"Glow in the dark." Luminous safety coating—emits light in dark. For office, home, etc. No. 184—O-Deluxe Kit. Dealers Net \$1.50



G-C CARBON-X
A good method to touch up worn and noisy spots on carbon volume controls. CARBON-X is an electrical conductor. No. 1205-2 oz. bottle. Dealers Net 45c

G-C NE-O-LITE TESTER

Handy, inexpensive Ne-O-Lite Tester that every serviceman, experimenter, etc., should have. Can be used on 60 V.A.C. to 500 V.A.C. or D.C. No. 5100—single tester on card. Dealers Net 30c. Display of 12 or 20 available.



G-C FELT-KOAT FLOCK FINISH SPRAY KITS

Easy to supply flock for refinishing turntables, cabinets, grilles, etc. Kit contains specially designed spray gun, 2 colors flock, undercoats, thinner, brush, instructions, etc. No. 180-2. Dealers Net \$6.45. Sold By All Jobbers.

Write for complete catalog today
RADIO DIVISION DEPT. D

GENERAL CEMENT Mfg. Co., Rockford, Ill., U.S.A.
Manufacturers of over 3,000 products
Sales offices in principal cities

**OUR 24th YEAR
SUPERIOR SERVICE
FIRST QUALITY LOW PRICE**

METERS

0-1 MA G.E. type DO-41, 3"	\$3.50
0-1 MA McClintock 90 ohm, 2"	2.45
0-1 Amp RF G.E. 2" model 8DW44	2.45
0-3 MA Gruen 2" scale 0-30:300:3000	1.95
500-0-500 Microamps WE 4" scale 50-0-50 3.75	
All above in bakelite case		

**OIL FILLED CONDENSERS
All Standard Brands**

1 mfd	600 volt DC	.45
2 mfd	600 volt DC	.49
10 mfd	600 volt DC	.98
2 mfd	1000 volt DC	.79
0.5 mfd	1500 volt DC	.25
0.25 mfd	2000 volt DC	.25
2 mfd	2000 volt DC	1.75
4 mfd	2000 volt DC	3.25
4 mfd	4000 volt DC	5.95
0.1 mfd	7500 volt DC	1.50

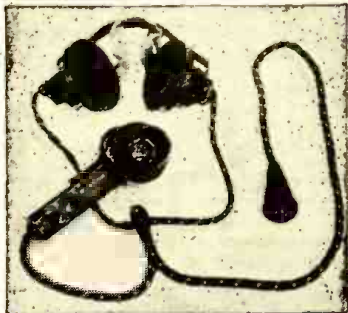

ARMY RADIO PHONES

They're Weather—Water and Shock Proof

When we say they are made to Army specifications, that's enough assurance they must be of best quality. These Army Radio Phones are perfect and were O.K.'d by Signal Corps Inspectors. These Dynamic Mikes and Receivers, were used on aircraft and tank inter-communication systems. Use them for recording, for batteryless phone, for pocket size set loud speaker or talk through your radio set. We bought a good many of these Radio Phones, they are brand new, and cost a great deal more than you can get them for. A complete dynamic hand mike. 2 earphones, headband, cord set. **\$3.45**
A wonderful buy for only

SELENIUM RECTIFIERS

For AC—DC Portables, Intercom power supplies. Replaces 29 types of Rectifier Tubes
1-595c
6-4985c
50-9980c
Each complete with instructions

SELSYN 5G Synchro Transmitter, used in pairs as transmitter and follower 110v AC per pair **\$5.00**
Indicator type 11-1 in armored case, per pair **9.00**
Heinemann circuit breakers—5-20-35 or 65 amp; 115v AC; magnetic type **.95**
Twin lead 300 ohms; per 100 feet **2.95**
RG8U 52 ohms coaxial cable; per 100 feet **4.25**

BC 645 A Transmitter-Receiver 420-450 Mc; 460-490 Mc; complete with 15 tubes, including W.E. 316A doorknob. Brand new with conversion diagram. For less than the cost of the tubes.... **\$14.95**

BC 406. 15 tube, 205 Mc. Fixed tuned receiver. Complete with tubes. **\$15.95**
Wt. 80 lbs.

SCHWEIN Free and Rate Gyro Operates from 24v DC. Complete in metal case ready for use **\$5.00**

If not rated 25% with order, balance C.O.D. All prices F.O.B. our warehouse New York. No order under \$2.00
We ship to any part of the globe

LEEDS RADIO CO.

75 Vesey St., Dept. 45
Cortland 7-2612 New York City 7

TRANSATLANTIC NEWS

(Continued from page 33)

tion. Many attempts have been made to reduce it by the use of special needles, of filter circuits and of different materials for the record blanks. Some needles are a little better than others, but none effects a cure. Filters are almost useless, since surface noise is random, occurring not on one frequency or narrow band of frequencies, but on all frequencies from about 1,500 cycles upward. Discs of soft plastic material, such as the vinyl compounds, may lessen the noise a little, but they also cut down the high-frequency response of the pickup. The reason? Well, it is just that with these softer materials what is known as "cold flow" is apt to take place when the needle is traversing the tiny, sharply bent curves of the grooves corresponding to the upper audio frequencies. The material has not sufficient rigidity to force the needle point to follow the grooves. Instead, the needle deforms—bends—the grooves as it traverses them and they spring back into their original shapes after it has passed. The microscope will show that the upper audio frequencies are on such a record, but when it is played cold flow prevents them from being reproduced.

Decca's first line of attack was to produce a pickup with no resonance within the audio range. Figs. 1, 2 and 3 illustrate its make-up. The body of the pickup is 1 3/8 inch in length, 1 1/2 inch in diameter and 5/8 inch in depth. When balanced on the tone arm its weight is six-tenths of an ounce. As will be seen, it is of the moving iron type and contains many interesting features. The rubber mount of the armature allows free lateral movement but enforces complete rigidity fore and aft. The magnets are so situated that when a record is being played they are little more than one sixteenth of an inch above its surface. The maximum flux change through the armature is thus obtained. The pivot of the armature, being near the top of the pickup, is well away from the area of flux change. The playing tip of the armature is of sapphire; after 1,000 records the pickup is opened by undoing the milled screw, the armature and its mount are removed and thrown away and replaced with a new armature complete with mount.

This pickup has no resonances below 14,000 cycles and surface noise is very slight when it is in use. Shellac is used for the record blanks, the particles of the filler being ground very fine and passed through a sieve with a mesh of 300 to the inch; they are thus too small to give rise to waves of audible frequency.

The recording head is of the moving coil type with very low mechanical inertia. The range of frequencies actually cut on the master record is from 30 to 14,000 cycles. No monitoring or contrast compression whatever takes place during recording. The gain control is set before recording begins to prevent

**GOVERNMENT
SURPLUS**

We have on hand a large selection of Radio and Electronic Equipment purchased from the United States Government, and solicit your inquiry on practically any equipment or component parts used by the Army or Navy. Listed below are only a few of the many items we now have in stock.

METERS

0-250 MA DC Weston Model 301, 3" case	\$2.95
0-50 MA DC G.E. Model D0-41, 3" case	2.95
0-1.8 KV DC-Completo Weston Multiplier	5.25
0-20 KV DC Weston Model 301, 0-1 MA FS, 3" case	3.25
0-150 V AC Weston Model 478, 3" case	2.95
0-1 Amp RF Weston Model 301, 3" case	3.25

CONDENSERS

.5 mfd, 2000V DC, CD type TJH, Oil Impregnated75
1. mfd, 2000V DC, CD type TJH, Oil Impregnated	1.00
4. mfd, 2000V DC, CD type TJH, Oil Impregnated	1.75
10. mfd, 1000V DC, CD type TJH, Oil Impregnated	2.00
Transmitting Cond. .0008 mfd—5000 VV DC, Saugamo type F21SH75

RELAYS

Time delay, Cramer type TD2-120S, 30 sec delay timer, 110 V 60 cycle 10 amp AC SPST make contacts	4.75
Relay Struthers Dunn type 8BX110, DPST make, 30 amps AC contacts 110 V 60 cycle coil	2.35
Relay Struthers Dunn type AD8T8, DPST 30 amp AC contacts, 3 amps 60 cycle coil	1.75
Relay Struthers Dunn type 8BX110, DPST make, 4 amp DC contacts, 125 V DC coil	1.75

CIRCUIT BREAKERS

Heinemann Circuit Breaker, 15 Amps. Curve 2, 120 V AC95
Heinemann Circuit Breaker, 20 Amps. Curve 2, 120 V AC95
Heinemann Circuit Breaker, 35 Amps. Curve 2, 120 V AC95

FUSES

2 Amp, 3 AG Littelfuse, 5 for12
100 for	1.98
15 Amp, 3 AG Littelfuse, 5 for12
100 for	1.98
1/4 Amp, 8 AG Littelfuse, 5 for12
100 for	1.98

MISCELLANEOUS

Choke, 3.8H @ 105 MA DC. Uncaused but tropicalized39
Heater strip, 230 V, 200 Watt Chromalox type PT-702, Screw terminals, 7" strip60
Cartridge heater 115 V 25 Watt, Immersion type, 10" long x 1/2" round case. With asbestos covered 10" leads, Chromalox type C-30450
500 ohm Pot, 50 Watt IRC, 1 1/2" x 1/4" shaft single hole panel mount95
18,000 ohm resistors, 50 Watt, 1/4" Ferrule mount RGS/U Coax cable, 52 ohms impedance, 50', with connectors	3.50
Selsyn, 110 V 60 cycle	3.95
Linesman's pole climbers	4.50
Safety belt with strap, State belt size wanted 5'7"	5.75
4 section vertical telescoping antenna, 6 1/2" to 23" extended, 3/4" OD at base, with base insulator and standoff slide support	10.50
Neon Bulbs, G.E. 1/4W, 115 V, BAYONET base T, 4 1/2 Bulb, type NE15
Spark plug suppressors25
100 for	3.50
Test Clip, Frankel w/pinpoint for making electrical connection without removing insulation04
Message Holder, excellent for station logs, regular letter size 8 1/2" x 11" with extra clip for folding spare sheets, also Protective cover, Ref. Signal Corps type	1.00
Jeweled lamp assembly, 1" diameter, Panel mount Candelabra screw base socket, Red Jewel29

SPECIAL \$25.00 OFFER

On a deposit of \$5.00 we will ship you C.O.D. Freight Collect a large quantity of Government Surplus Radio Items subject to your inspection and approval. If, after inspecting you are not more than satisfied, return to us Freight Collect and all it will have cost you will be freight charges one way. You should be able to dispose of a few of the items that you may not need for the entire cost. This is the cheapest way we can sell you War Surplus Radio Material. Our warehouses are filled with thousands of choice Government Surplus Radio Items. Lots of them we do not have in sufficient quantity to advertise nationally and the cost of inventorying, itemizing, corresponding, etc., would only increase their cost; therefore we make this offer.

Above Prices F.O.B. Baltimore
Minimum Order \$2.00

The Abell Distributing Company

5 E Biddle St. Baltimore 2, Md.
Send for Our Flyers
Name Items Interested In

an overload occurring on the loudest passages. It is not touched again. When a very soft passage occurs the level of the music is actually allowed to fall, if need be, below the noise level. This may sound surprising, but it is amply justified by the results. During the playing of an orchestral record one is so entranced by hearing the music played as the conductor's baton (and not the

radio-phonographs, almost all of which have loudspeakers peaking at or about this point and then showing a falling characteristic. It is found in practice that a rise of 8 db per octave is the most that can be used profitably: if the rise is steeper the pick-up needle is liable not to track properly at high frequencies owing to the sharpness of the curves of the grooves.

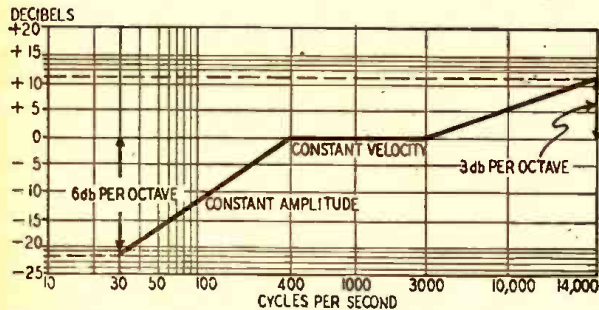

Fig. 4—The recording characteristic curve for frr recordings.

monitor's knob!) directs that the hiss, which is noticeable only on passages that are exceptionally *pianissimo*, is not annoying.

The recording characteristic is shown in Fig. 4. It will be seen that from 400 to 30 cycles at constant amplitude there is a fall of 6 db per octave. After the change-over at 400 cycles the characteristic (constant velocity) is level to 3,000 cycles. From that point upwards the rise is 3 db per octave. This rise is deliberately made to begin at 3,000 cycles because it is realized that the records will often be played on ordinary

Though these records can be used with very good results on ordinary radio-phonographs, only a specially designed reproducing instrument can bring out their full beauty. Radio and radio-phonograph designers are usually well satisfied if the harmonic distortion of the reproduction does not exceed 5 percent. This undoubtedly fulfills most requirements, so long as the a.f. response does not extend much beyond 5,000 cycles. But when an amplifier is capable of a response up to 14,000 cycles such a percentage of harmonic distortion would cause unpleasant effects owing to the production of parasitic difference and summation notes, whose number increases as the frequency range is widened.¹

Many textbooks state that phase dis-

¹These records, imported from England, are being sold to a very limited market in the United States, the supply being very short.

(Continued on page 68)

Electronics Made Easy!



Magi-Klips KIT

Build 18 Experiments at Home—
No Tools!

RADIO RECEIVER, HOME BROADCASTER, PHOTOELECTRIC RELAY, CODE PRACTICE OSCILLATOR, SIGNAL TRACER, REMOTE CONTROL RELAY, Phonograph Transmitter, Intercommunication Amplifier, Code Transmitter, Radio Frequency Oscillator, Telephone Line Amplifier, Electronic Switch, Phonograph Amplifier, Temperature Control Relay, Contact Detector, Electronic Metronome, Interval Timer (one-shot), Interval Timer (repeating).

With a Magi-Klips kit you cover the entire field of radio and electronic engineering theory quickly in your spare time. It's simple to arrange the components for each circuit. No soldering. No tedious wiring. Kit operates on 110 v. AC or DC and includes 35Z5 rectifier, 50L6 power amplifier, 12SL7, double triode, powerful 4" speaker-miko, plate relay, broadcast and SW coils, tuning condenser and generous supply of resistors, condensers, chokes, extra wire. Parts worth double the price of kit.

Kit's 48-page manual has complete instructions and diagrams easily followed by the beginner. Remember, you need no tools, except possibly a screwdriver, with a Magi-Klips electronic and radio experimenter's kit **\$29.75** complete

SCHOOLS—Magi-Klips KITS are excellent equipment for laboratory and classroom. Write for special discount.

DEALERS—Some territories open. Write for your trade discount.

DEER & TAYLOR COMPANY

Dept. C, 3340 Milvia St.

Berkeley 9, Calif.

Please ship Magi-Klips electronic kit (s).

Please mail illustrated folder on the Magi-Klips kit.

Name

Street

City

State

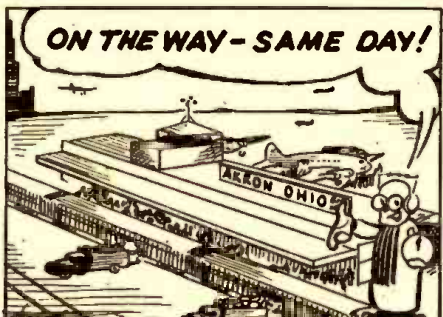
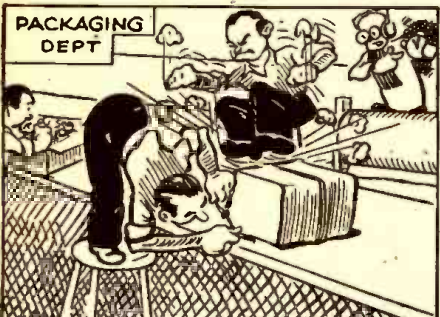
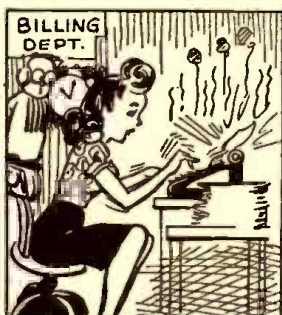
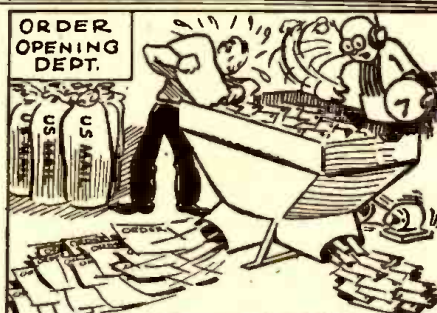

MAIL TODAY **OLSON RADIO WAREHOUSE**
73 E. MILL ST., DEPT. 63, AKRON, OHIO

Yes, I too want Olson's
"Same-Day Service." Send me your
new big Bargain Book FREE.

NAME

ADDRESS

CITY

STATE

ACTUAL TAPE RECEIVED AT 50 WORDS PER MINUTE ACTUAL TAPE RECEIVED AT 50 WORDS PER MINUTE

Code Recorder BC-1016

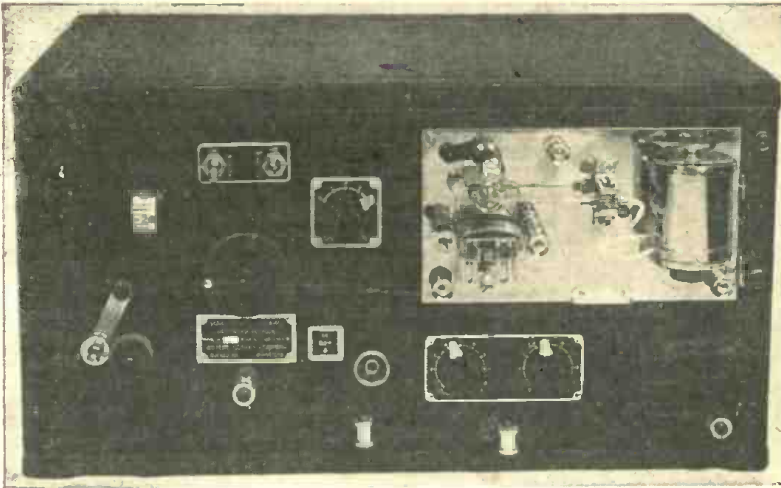

- **GENERAL**—Designed for ink recording of standard code signals at speeds up to 400 words per minute on a $\frac{1}{8}$ " paper tape. Made by Waters Conley Company, Rochester, Minnesota.
- **APPLICATION**—a) Designed primarily to be connected to the output circuit of a radio receiver. Operates on a signal from 0.15 to 50 volts, usually connected directly across the speaker voice coil so that signals may be heard as well as automatically recorded. Frequency response 500 to 5000 cycles per second.
b) Direct Keying recording from an automatic keyer or from a hand keyer to record messages or for code practice, etc.
c) Can be operated from a telephone line which carries the radio signals to the recorder from a remote location.
- **POWER SUPPLY**—Operates on 117, 170, 210 or 240 volt 50-60 cycle alternating current or within 10% of those voltages.
- **POWER CONSUMPTION**—Approximately 140 watts operating approximately 85 watts in standby.
- **COMPONENTS**—Fully equipped and assembled. Just connect to voice coil of the speaker on your receiver (or to a key for code practice) and plug into your power line.
Contains the following:
Bodine variable speed drive motor with fan
Three pens (use Higgins "Eternal Black" ink)
Power Cord
Technical manual with instructions and wiring diagrams
5 Spools of tape (1000' spools). These spools can record up to 20,000' of messages if necessary (extra tape available from radio supply houses)
Amplification—bridge circuit with the following tubes:
1 6SJ-7 1 6SN-7 2 5U4-G 1 6HG 2 6LS

Complete in Steel Cabinet 10 $\frac{1}{4}$ " high x 19 $\frac{1}{4}$ " wide x 14 $\frac{5}{8}$ " deep; wt. 80 lbs. Designed to fit any standard 19" rack. Height is 8 $\frac{3}{8}$ " and wt. 65 lbs. when cabinet is removed for rack mounting.

\$24.95
NET
F.O.B. N. Y.

SURPLUS NEW GUARANTEED

No C.O.D.'s sent unless accompanied by 25% deposit. Orders accepted from rated concerns. (Dun & Bradstreet) Public and Educational Non-Profit Institutions, Governmental Agencies, etc., on open account basis.

MARITIME SWITCHBOARD

340 Canal Street

New York 13, New York

ACTUAL TAPE RECEIVED AT 400 WORDS PER MINUTE ACTUAL TAPE RECEIVED AT 400 WORDS PER MINUTE

DC POWER SUPPLY & BATTERY CHARGER

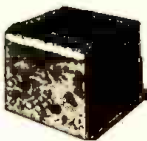

Just the thing to demonstrate Auto Radios or for the serviceman to repair them. Eliminates storage batteries and assures accuracy in your demonstration. Works on 115vAC 50-60 cycle delivering 6vDC at 4 amp only \$16.75 or 6vDC at 10 amp for \$25.

GREENWICH SALES CO.

59 Cortlandt St. New York City 7



ATTENTION Amateurs-Experimenters-Inventors

Cut your cost on radio supplies and equipment in half. Clip coupon today. Hundreds of "hard to get" war surplus items along with the best in standard brand equipment—all at great savings to you. Let us know your particular requirements. IMMEDIATE DELIVERY.

SEND THIS COUPON TO

NIAGARA RADIO SUPPLY CORP.
180 Greenwich St.
New York 6, N. Y.

Name

Address

City

State

Call. No.



TRANSATLANTIC NEWS

(Continued from page 67)

tortion is of small account in radios and phonographs. This may be true enough where the cut-off is in the region of 4,500-5,000 cycles; but it does not hold good for wide frequency range audio amplifiers. Fig. 5, by illustrating a very

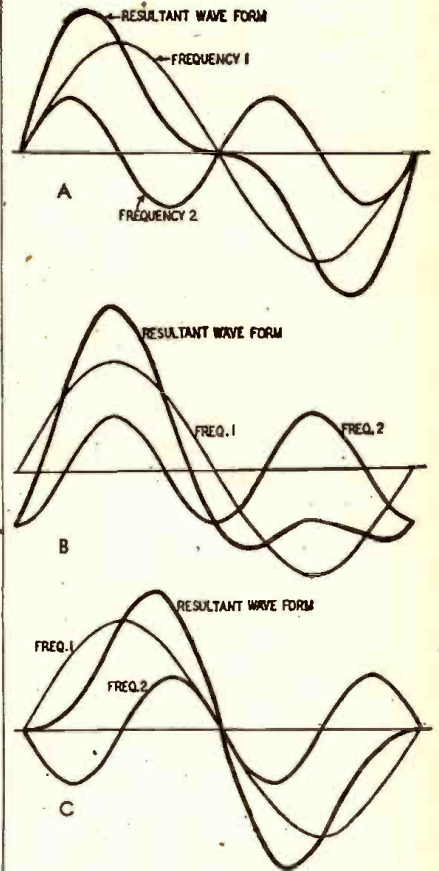

Fig. 5—Waveform changes from phase change.

simple example, will serve to show what effects phase distortion may have. Suppose that a sound made in the studio consists of two frequencies with the phase relationship seen at A; if the phase of the higher frequency is shifted 90 degrees, as at B, during recording or reproduction the resultant waveform has a totally different shape. The shape is again entirely altered if the phase-shift is 180 degrees, as seen at C. B and C represent very simple forms of phase distortion. Imagine what would happen to the complex sounds made by a full orchestra if they were reproduced by a phonograph with a wide frequency range in which phase distortion took place on the grand scale! Phase distortion is then of great importance in an amplifier with a range of 30-14,000 cycles and steps have been taken to reduce it to negligible proportions.

The Deccola, as the reproducer is called, contains four stages of triode Class-A amplification. Careful design has reduced the harmonic content to 0.5 percent. Three 12-inch loudspeakers are used, arranged on the convex arc of a circle so that the sound is evenly

NOW AVAILABLE FOR IMMEDIATE DELIVERY FROM STOCK!

THE NEW MODEL 670

SUPER-METER



A Combination VOLT-OHM-MILLIAMMETER plus CAPACITY REACTANCE INDUCTANCE and DECIBEL MEASUREMENTS.

Added Feature: The Model 670 includes a special GOOD-BAD scale for checking the quality of electrolytic condensers at a test potential of 150 Volts.

Specifications

D.C. VOLTS: 0 to 7.5/15/75/150/750/1,500/7,500 Volts.
 A.C. VOLTS: 0 to 15/30/150/300/1,500/3,000 Volts.
 OUTPUT VOLTS: 0 to 15/30/150/300/1,500/3,000 Volts.
 D.C. CURRENT: 0 to 1.5/15/150 Ma.; 0 to 1.5 Amperes.
 RESISTANCE: 0 to 500/100,000 ohms; 0 to 10 Megohms.
 CAPACITY: .001 to .2 Mfd., .1 to 4 Mfd. (Quality test for electrolytics.)
 REACTANCE: 700 to 27,000 Ohms; 13,000 Ohms to 3 Megohms.
 INDUCTANCE: 1.75 to 70 Henries; 35 to 8,000 Henries.
 DECIBELS: -10 to +18, +10 to +38, +30 to +58.
 Housed in a rugged, crackle-finish steel cabinet complete with test leads and operating instructions. Size 5½" x 7½" x 3".

\$28⁴⁰

PLEASE PLACE YOUR ORDER WITH YOUR REGULAR RADIO PARTS JOBBER. IF YOUR LOCAL JOBBER CANNOT SUPPLY YOU, KINDLY WRITE FOR A LIST OF JOBBERS IN YOUR STATE WHO DO DISTRIBUTE OUR INSTRUMENTS OR SEND YOUR ORDER DIRECTLY TO US.

SUPERIOR INSTRUMENT CO., 227 Fulton St., Dept. RC-5, New York 7, N. Y.

**RADIO PARTS
SOUND SYSTEMS
ELECTRONIC
APPARATUS**

**Depend on
RADOLEK**

Radolek's big Free Profit Guide Catalog and Profit Bulletin supplements keep you abreast of the rapidly changing radio situation. Buying from Radolek means greater values, better service and more profits. Make Radolek your buying headquarters.

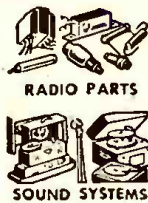

RADIO PARTS
SOUND SYSTEMS

FREE CATALOG



Large Stocks
Fast Service

SEND TODAY!

RADOLEK CO., Dept. C-127
601 W. Randolph St., Chicago 6, Ill.
Please send your FREE Profit Guide Catalog.

Name.....
Address.....

SAVE AT RADOLEK

distributed and there is no beaming of the high audio frequencies. One can walk about the room without finding the high notes stronger in some places than in others.

The Deccola is an electric phonograph only; the present models have no radio equipment. You might think that no one now would buy a high-priced phonograph (the Deccola costs the equivalent of over 800 dollars!) no matter how good its performance might be.

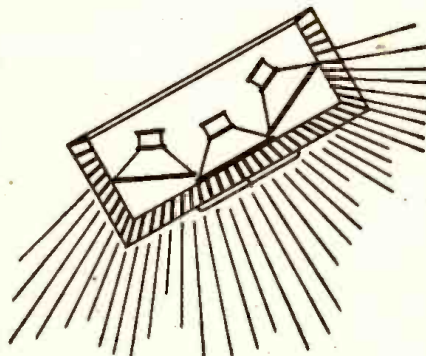

Three speakers provide wide-angle coverage.

Well, it has been on the market only a short time and most of our English factories were closed down for several weeks at the beginning of this year through lack of coal; but over 2,000 have been sold so far in this country and the demand is steadily increasing.

*The phonograph is being sold in the United States by an American agent for \$1400.

DEALERS! SERVICEMEN!

These VALUES mean PROFITS for YOU!

All merchandise offered below is BRAND NEW, and FULLY GUARANTEED. Our enormous stocks and facilities enable us to give you IMMEDIATE DELIVERIES on all merchandise listed.

TERRIFIC BUY FOR P.A. MEN!

Astatic R-3 Crystal Handmike, with 6 ft. R.C. Mikro Cable **\$4.50**



WILLARD 2-VOLT STORAGE BATTERY

Exact replacement for GE portables — brand new each **\$2.75**

Willard 6-volt (3-cell) storage battery, brand new **\$7.95**

Magnetic Pickup **\$2.20**
 Shure Magnetic Cutting Head, Special **\$1.95**
 Telegraph Key Sig. Cords 1-38 **.99c**
 7-prong 2-volt Radio Vibrator for Portable & Farm Sets, Replacement for GE LB-530 **\$1.65**

LOOK AT THESE PM SPEAKER VALUES!
 Alnico 5 4" PM **\$1.30**
 Alnico 5 5" PM **1.45**
 Alnico 5 6" PM **1.95**
 Alnico 5 8" PM **3.25**
 450 ohm 4" Dynamic **1.50**

MAGNAVOX "FP" FILTER CONDENSERS
 8 mfd 500 volts **45c**
 16 mfd 500 volts **65c**
 8-8 mfd 500 volts 150/150/25 V **70c**
 40-20-20 mfd 150/150/25 V **40c**

METER SPECIAL!
 3" DC Milliammeter 0-1000 mils **\$1.95**

VOLUME CONTROLS
 25M ohm Your Cost, Any Type
 100M ohm
 250M ohm With Switch **40c**
 500M ohm Less Switch **28c**
 2 Megohm Switch
 22½ VOLT "B" BATTERIES with leads **35c**
 MIDGET VISE-SPECIAL! **\$2.19**

MINIMUM ORDER \$5.00
 PLEASE INCLUDE 25% deposit with order—Balance C.O.D. All above subject to prior sale.

G & G RADIO PARTS SERVICE
 53 VESEY STREET · NEW YORK 7, N. Y.

"More than 10,000 satisfied Radio Dealers and Servicemen since 1940"

Mr. Dealer and Service Engineer:

Shake hands with
now in this

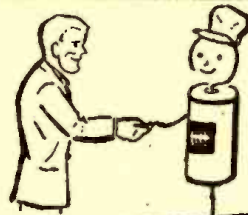

"Illini Hycap"

"GET-ACQUAINTED PLAN"

This is an unusual test offer—
now you can test for yourself the high
efficiency and quality of the well known "Illini-Hycap" condenser.

HERE'S THE SIMPLE "GET-ACQUAINTED" PLAN: 1. Advise us right away which one of the two illustrated condensers you wish to test (select one). 2. Enclose **15c** only in stamps or coin (to cover cost of mailing and handling), along with the name of your local jobber and we will promptly send you the condenser of your choice, together with our latest catalog.

You'll want more of these long-life "Illini-Hycap" condensers when you see how they improve your service work and customer satisfaction. Buy them from your jobber. This offer may not be repeated again—

ACT NOW!



- 1—"Illini-Hycap" 20MFD.
Working voltage 150 D.C.
Part No. IHT-2015.
- 2—"Illini-Hycap" 8MFD. Working
voltage 450. Part No.
IHT-8450.



ILLINOIS CONDENSER CO.
1616 NORTH THROOP STREET • CHICAGO 22, ILL.

RECEIVER XMITTER

\$351.00
Value



Your
Price

\$14.50

Write for Quantity Prices

FREE A COMPLETE SET OF
TRANSMITTING AND
RECEIVER TUBES
WORTH \$35.00

BC-654-A is a combined transmitter and receiver designed for portable or vehicular operation. The frequency range of both transmitter and receiver is continuous from 3700 to 5800 kilocycles; all stages **same** tuned by anti-back lash worm gear dial mechanism.

YOUR GUARANTEE

We will ship you at once the above receiver and xmitter and include **FREE** a complete set of 13 receiver and xmitter tubes.

RUSH YOUR ORDER

\$5 Deposit—Balance Express Collect

MANUEL KLEIN IND. Corp.
74 C. CORTLAND ST. NEW YORK 7, N. Y.

NEW SUBMINIATURE PRINTED CIRCUITS

(Continued from page 65)

per day at the cost of a few cents per plate. It is not necessary to cut wires to length, bend them into shape, and individually solder or connect them to a chassis. With the printed technique, each unit is a reproduction of the master patterns, which reduces line rejects to a minimum. Substantial savings in wiring and inspection and reduction of rejects makes the process economically attractive.

Work on the miniature transmitter and receiver units was to a great extent carried out by the members of the staff of the Ordnance Development Division, National Bureau of Standards, voluntarily devoting their after hours to the program. Space does not permit naming all who showed extreme interest and assisted in producing the units. Specific acknowledgment is made by Messrs. Brunetti and Cronin to J. J. Gurtowski, Robert L. Henry, and Miss C. G. Moon, who made important contributions to the methods and carried out the printing of the units. The electronic phases were executed by Max Shufer, G. J. Tedore, P. E. Landis, L. A. Riley, and E. A. Vogelsang. Additional work on the development and perfection of new methods of printing electronic circuits and studies of their performance is being carried on in the Division by a group under the supervision of P. J. Franklin and Dr. R. W. Curtis.

S.S.S.

"Servicing by Signal Substitution"

Learn about this modern dynamic approach to radio servicing with **ONLY BASIC TEST EQUIPMENT.**

... Fully described in a 120 page book available from your Precision Distributor or factory at 35¢.

... Schools are invited to inquire regarding quantity orders from our Educational Division.

PRECISION

APPARATUS COMPANY INC.
ELMHURST 4, N. Y.

Manufacturers of Fine Test Equipment
RADIO • TELEVISION • ELECTRICAL • LABORATORY

G&E CRAFTSMEN'S BARGAINS

Hi-Power Electric Drill

Heavy duty 3/4" drill.
Light weight. Three
Jaw keyless chuck. Oil bronze bearings.
6 ft. flexible rubber cord with plug.
600 rpm at full load. Operates at 110
V. AC or DC.
No. 6202 Each **\$17.95**

A Treasure Chest of Radio Parts

Contains transformers, condensers, dial controls,
insulators, terminal connectors, coils, practically
all types of switches. Many more useful items.
No. 6508 15 lb. Kit for only **\$4.50**
Send check or money order, including
postage. No C.O.D.'s. Write for new free

G & E EQUIPMENT SUPPLY CO.
Dept. RC-1 400 N. SANGAMON ST., CHICAGO 22, ILL.

JOBBER-DEALERS AND SERVICEMEN!

IF YOU NEED TUBES—WE'VE GOT 'EM!

Send us a trial order. This will convince you we merit your patronage, based on low prices, quick delivery and FULLY GUARANTEED TUBES and Standard brand merchandise.

Type	Each	Lots of 10 Each	Type	Each	Lots of 10 Each
1H5GT	65c	55c	7B7	50c	40c
1U5	39	35	7C6	50	40
1V	60	50	7Y4	50	35
5U4G	50	40	7X7	50	40
5W4GT	50	45	7AF7	45	40
5Y3GT	40	37	XXL	50	40
5Y4GT	45	37	12A8GT	60	49
6A7	62	50	12J7GT	50	42
6A8GT	62	44	12Q7GT	53	45
6AB7	69	65	12SA7GT	50	39
6AC7	69	65	12SQ7GT	50	39
6C6	50	42	12SK7GT	50	40
6BA6	75	50	24A	50	39
6F6GT	45	40	25L6GT	68	50
6H6	48	44	25Z5	63	50
6J5GT	63	50	25Z6GT	62	51
6K6GT	59	39	27	42	38
6K7	60	50	35L6GT	60	50
6K7GT	60	44	35Z3	65	60
6K8	60	54	35Z5GT	55	42
6L5G	65	40	43	90	60
6SA7GT	50	45	45	66	50
6SF7	65	56	47	92	55
6SJ7	50	49	50L6GT	65	50
6SK7	55	48	56	51	45
6SK7GT	60	38	75	67	44
6SL7GT	60	52	77	45	39
6SQ7	50	45	80	40	38
6SQ7GT	50	45	84/6Z4	58	45
6U7G	60	48	117Z3	85	60
6V6GT	83	50	12AT6	75	45
6X5GT	55	45	12BA6	75	45
7A4	69	40	12BE6	75	45
7B6	50	40	50B5	54	42
1A5GT	60	50	32L7GT	90	80
1N5GT	60	50			

(ALL TUBES FULLY GUARANTEED)

1625 TRANSMITTING Beam Power, Amplifier. Same as 807 except 12.6 volt filament medium 7 pin base **19c ea.**
 1629 Tuning Indicator—Tri. (Magic Eye) tube **25c ea.**

ADJUSTABLE PANEL LAMP ASSEMBLY Mounts in 3/8-inch hole on panels to 3/8 inch. The red jewel assembly is with shutter that controls the visible glow. Takes standard miniature bayonet base lamps replaceable from the front panel. Closeout Special, while they last **\$.25 each.**

XTRA SPECIAL BUYS!

LEADING BRAND AC PHONO MOTOR



60 cycles, 115 volts with Turntable with Standard Make Crystal Pickup.

\$4.95

Complete

SIGNAL CORPS DUAL HEADSETS

2000 ohms with 6 ft. cord and tips. Also 8000 ohms high impedance, with two rubber ear cushions, cord and phone plug, individually boxed.

\$1.85

List Price \$12.50 each



BRAND NEW WILLARD #20-2 2 VOLT STORAGE BATTERY

Used in General Electric model #530 charge A PACK portables. Suitable for all Farm Radio Sets. Individually boxed. List Price **\$2.95** Special each **\$8.95**



Convert Any Record Player to Wireless—with this Complete Assembled and Tested 2-Tube Wireless. Phono Oscillator Less Tubes **Special \$3.95**

Standard make 6 Volt 4 prong, Auto Vibrator **\$1.19 ea.**

STANDARD BRANDS

At Outstanding Prices!

12" P.M. Speaker
 Alnico 5 Magnet
 Packed 4 in a carton **\$.95 ea.**
 Lots of 12 **\$66.00**

8" F.M. Speaker **\$.275 ea.**
 Lots of 12 **\$30.00**

5" P.M. Speaker **\$1.39**
 6" P.M. Speaker **1.89**
 4" P.M. Speaker **1.29**

P.P. Input transformers **\$.95 ea.**
 Lots of 12 **\$.85 ea.**

40 x 40 Electrolytic Cond. 150 V. **\$.49**
 50 x 30 Electrolytic Cond. 150 V. **\$.49**
 30 x 20 at 150 V. and 20 mfd at 25 Volts. **.45**

500 M ohm V.C. with Switch,
 2 1/4" Shaft. Popular Brand. **\$.42 ea.**
 Lots of 12 **\$.480**

50 Mil Power Transformer
 Primary 110 V, Secondary 6.3
 Rectifier 5 V, H.V. 480 V C.T. **\$.195**

456 K.C. IF Coils
 Input & Output, medium size **\$.49 ea.**

WRITE, WIRE OR PHONE FOR OUR SPECIAL QUANTITY PRICES

25% deposit on all orders, balance C.O.D., F.O.B. New York

SENCO RADIO, Inc.

96 WARREN ST., N. Y. 7, N. Y.
 TEL. CORTLANDT 7-6065

BATTERY SUPERHET USES THREE TUBES

(Continued from page 31)

After the wiring has been completed and everything seems in order, insert the tubes in their respective sockets. Be careful not to damage the tiny prongs of the small tubes. Plug in the A- and B-batteries and turn on the set. Now you are ready to line up the set. It may be better to have it lined up by a serviceman, who has all the necessary equipment, but if this is not possible, the procedure is as follows:

First connect the set to a good aerial and ground, and open the gang condenser to about 1,600 kc. You may hear a station, but it will be weak. With an insulated screwdriver, set all four trimmers on top of the i.f. transformers to the point giving maximum signal strength. The i.f. is 456 kc. Next fully close the gang condenser to about 600

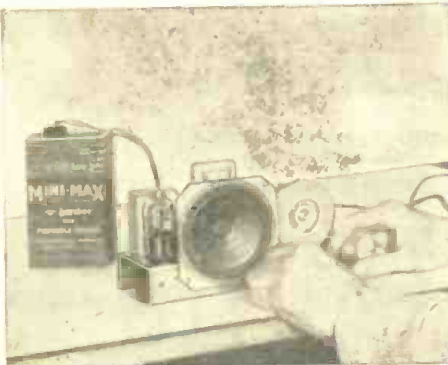

The completed receiver.

kc and adjust the padding condenser for resonance. It may be necessary to go back and touch up the i.f. trimmers slightly to secure maximum signal strength. Most i.f. transformers are aligned at the factory, so little adjustment should be necessary. A constructor who lacks a signal generator to accept the factory adjustment as approximately correct, and confine his alignment to the oscillator and r.f. trimmers and the padder.—Editor

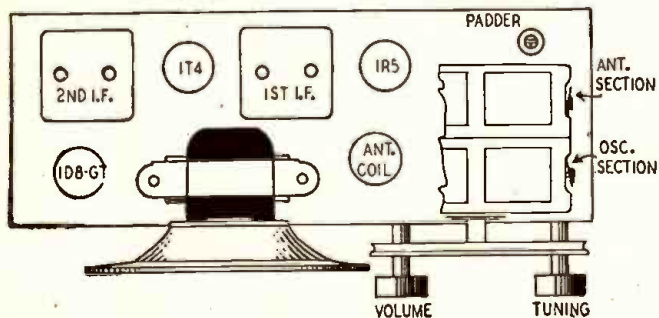

This layout, with slight modifications, can be used with any parts.

RESISTORS

IS OUR BUSINESS

1/2 WATT - 1 WATT - 2 WATT
ANY QUANTITIES
ANY TOLERANCES

Immediate Delivery

RESISTORS KIT

\$2.05 each

(Assorted and Not Mixed / 100 pcs.)

60 pcs. 1/2 watt and 40 pcs. 1 watt

ELECTRONIC PARTS AND COMPONENTS

LEGRI COMPANY, Inc.

848-850 Amsterdam Avenue
 New York 25, N. Y.

JOBBER AND DEALERS CARRY

The **New ELECTRON-O**

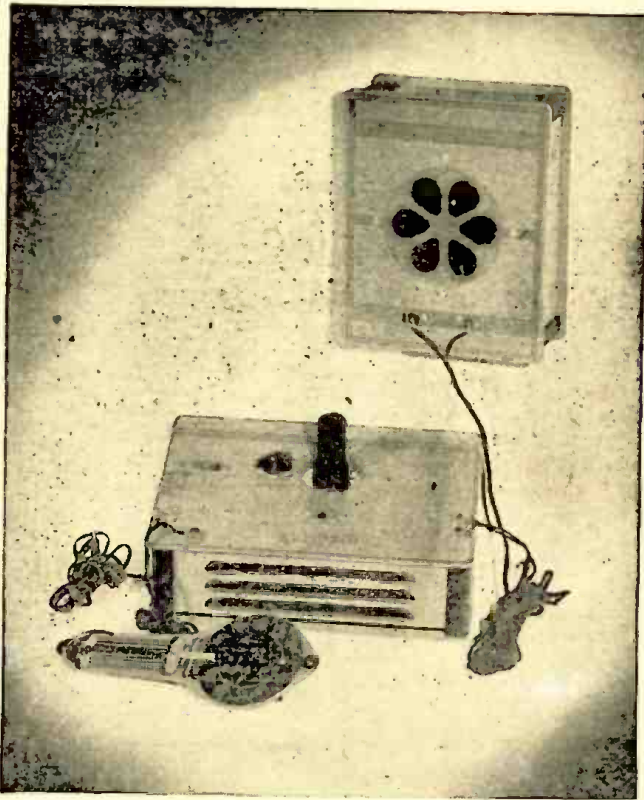

"Make it Yourself"
Kit

Junior Public Address Kit No. 200

DEALERS' NET PRICE \$14.95

SOUND AMPLIFYING SYSTEM

Construction kit contains everything needed—no "extras" to buy

- **YOU BUILD IT YOURSELF—EASILY—QUICKLY**
12 page instruction book, fully illustrated—easy-to-read, easy-to-understand, easy-to-follow. Shows each simple operation step-by-step.
- **IT REALLY WORKS**
—operated on 110 volts AC or DC House current carbon microphone—electronic amplifier and powerful dynamic loudspeaker all connected together, operate same as big amplifying systems.
- **YOU LEARN ELECTRONIC PRINCIPLES**
All parts are explained and illustrated. All diagrams are simplified for the novice.
- **NOTHING TO WEAR OUT**
except small flashlight battery which lasts for months.
- **SAFE—AS EASY TO OPERATE AS YOUR RADIO**
You and the whole family and your friends will have many hours of fun and entertainment "Talking over the milk"—holding "Auditions"—picking up sound from the radio—piano or any musical instrument—even staging a "radio" program of your own, right in your own home!

For highest quality radio parts, test equipment and radio equipment at lowest prices, write for catalogue to

Exclusive U.S.A. Distributors

RADIO DEALERS SUPPLY CO.

135 Liberty Street, New York, N. Y.

All orders and inquiries will be handled by our dealers in your vicinity.

"SHOOTING STARS" TRACKED BY RADIO

(Continued from page 26)

exercise a profound influence over the frequencies used for FM broadcasting as well as for long-range radio communication and navigation.

One way, points out the Bureau of Standards, in which meteors may affect radio waves is to cause "bursts" on FM channels. Some scientists, notably Dr. J. A. Pierce of Cruft Laboratory, Harvard University, contend that a major share of the ionization of the E layer of the ionosphere may be caused by meteors. Up-to-the-minute information on the behavior of the E layer is of basic importance because it governs radio frequencies employed for radio communication and radio navigation. The heat set up by friction as the meteors travel at a great velocity through the atmosphere is sufficient to vaporize the solid matter and create a trail of hot ionized gas in the vicinity of the shooting star. This blaze of hot gases gives off a visible glow. These gases and the near-by atmosphere are seemingly highly ionized.

"Ionospheric investigations," we are told by the Bureau of Standards, "have shown that ionized gases will reflect radio waves below a given frequency, allowing higher-frequency waves to pass through. The frequency that will just be reflected by a region of ionized gases is proportional to the square of the density of ions. Because the amount of frictional energy dissipated by a meteor, the hot gases in its trail should be ionized for a brief instant to a much greater extent than is the ionosphere. It is known that the 100-megacycle radar waves penetrate the ionosphere. However, the ionization in the trails of the meteors should be sufficiently intense to reflect radio waves at least in the region of 100 megacycles, a frequency relatively low in terms of modern radar, but much higher than the frequencies used for long-distance sky-wave radio.

"Supporting evidence for these contentions was the fact that interference encountered on the old frequency-modulation broadcasting frequencies in the form of 'bursts' (parts of programs from long-distance stations interfering with local station performance) had been found to coincide with the appearance of meteors. Further, it had been reported that during the war radar operators tracking V2 rockets had been confused by reflections from meteors. Other radar observers, such as O. P. Ferrell, working in an unofficial capacity, in India, had actually made observations which coincided with the visual observations of meteors.

"Out of the research on the effect of such phenomena will come decisions as to which frequencies are the best for the various types of radio services. These recent tests, together with the observations with the moon as subject, indicate that radar, besides being a plane locator and navigation device, is a valuable tool for the study of radio-wave propagation and is finding also a place as an instrument in the field of astronomy."

SERVICE MEN!

- RCA Radlotron
- Tungsol
- Raytheon
- Sylvania
- New Astatic QT-J
- Nylon Crystals

Tubes, Parts & Equipment
Write for our latest bulletin, Dept. C2
Distributors of **RADIO EQUIPMENT**

CHIEF ELECTRONICS

104 MAIN STREET, POUGHKEEPSIE, N. Y.
The Square Deal Supply House

PEN-OSCIL-LITE

Extremely convenient test oscillator for all radio services; alignment • Small as a pen • Self powered • Range from 700 cycles audio to over 600 megacycles u.h.f. • Output from zero to 125 v. • Low in cost • Used by Signal Corps • Write for information.

GENERAL TEST EQUIPMENT

88 Argyle Ave. Buffalo 9, N. Y.

Output Transformer (to match 50L6 tube)	\$.39
Electrolytic Condensers 20/20—150 V26
Three Tube Phono Amplifier, complete with tubes, vol. control	3.70
Tubular Condensers .01-600 V (per hundred)	2.95
Radio Tubes: 50L6 49	35Z5 42 Standard
Radio Tubes: 50B5 49	35W4 42 Brand
5" PM Speaker Alnico #5 Magnet	1.22

ALSO DYNAMIC SPEAKERS, VOLUME CONTROLS, 72 OHM COAXIAL, ETC. SEND FOR LIST
BROOKS RADIO DIST. CORP., 80 Vesey St., Dept. A, New York (7), N. Y.

INTERMITTENT ALARM

(Continued from page 34)

3. Adjust volume control of radio to normal audio output level.

4. Connect the Signalometer clips across primary of output transformer of radio under test. The output should drop to below audibility. If necessary, reduce the input from the signal generator.

5. Turn on the Signalometer line switch and set the potentiometer arm for greatest resistance. After heating, the warning tone should be heard.

6. Gradually rotate the Signalometer potentiometer arm, decreasing the resistance until the warning tone stops. The position of desired sensitivity will be located close to or slightly beyond this point.

How the circuit works

Operation of the Signalometer is simple. The small audio voltage which appears across the secondary of the input transformer is amplified by the 6J5. The rectifier half of the 6SL7 then delivers a positive voltage to the grid of the other half, which is triode-connected. This causes a heavy plate current to flow, resulting in a large voltage drop across the 250,000-ohm potentiometer in the plate circuit. When the set fades, no voltage is delivered to the 6J5 for amplification, and the triode half of the 6SL7 is cut off, due to its large cathode resistor (22,000 ohms). The voltage at point P, the potentiometer's center arm, rises, and the neon tube goes into oscillation.

The voltage across the potentiometer will be high when the plate current in the second half of the 6SL7 is low and vice versa. Therefore it can readily be seen that loss of gain or fading in the radio under test produces a higher voltage across the potentiometer which in turn causes the neon tube to operate as an audio relaxation oscillator in conjunction with the 32L7 grid circuit. The potentiometer arm can be adjusted for various degrees of fading. The arm is advanced to the point of oscillation and then reduced slightly below this point. Of course, too critical an adjustment might cause the Signalometer to go into oscillation because of slight line voltage variations or normal signal generator drift. The signal generator should be fairly stable and capable of producing a constant non-varying voltage output.

The signal generator voltage should be sufficient to allow the neon to start or stop by adjusting the potentiometer arm. Too low a voltage from the signal generator will result in a constant tone, regardless of the position of the arm.

Applications of the instrument

The device has many uses. Radios can be given a routine fading intermittent and noise test before being returned to the customer, with the full assurance that any fading complaints (Continued on page 74)

"TAB" Electronic Parts

New Guaranteed That's A Buy

TBY NAVY TYPE
CLG 20144 VI-
BRATOR POWER
& STORAGE DAT-
TERY CLG 10029
UNIT NEW
MANUALS 11 R 1
4 1/2" Dph 1 1/2
9/16" width
6 1/2" MFGRD BY
ELECTRONIC
LABORATORIES
& W I L L A R D
STORAGE DAT-
TERY CO RATED
4V/40AH NON-
SPILL, INCLUDES
BOTTLE OF ACID
VIBRAPACK Out-
put Voltage Reg-
ulator DC 50V &
150V 30ma 3V/
375 ma, 1.5V/
200ma, 7.5V/20
ma Wgt 2 1/2 lbs.
2 unfs plug to-
gether battery
type plug on side-
battery recharge-
able from 6V sig bat.
WVWZ PORT-
LAND SUPPLY
ABLS

"TAB" SPECIAL 3 for \$1.00
Additional CK-1003 tube vibrator fuses... \$3.95
BLOWER-AIR 28V DC AC operation 1000CFM... 1.95
BLOWER-AIR 115V/60CY, Dual 200, CFM... 13.95
CRYSTAL RECTIFIER IN21, 22, 23, Three for 1.25
RF NEON SIG-Lite U/G/T R Indicator, 5 for 1.00
WE DYNAMIC Beamometer Mike 201 cable... 7.95
AMATEUR CRYSTALS MTD FOUR FOR... 3.00
ANTENNA A-27 DUMMY LOAD, CONTAINS
N.I. piague RES & VAR CONDNR 100MMF/
300V-IN METAL CASE... 1.95
FUSE KIT 300 ASSTD BUSS & LITTLE FUSES 3.95
HARDWARE KIT GOOD ASSMNT ONE POUND .99

CHOKO 8HY/100ma HV Insid Cased, 2 for 2.20
CHOKO 8HY/200ma Cased, 2 for... 2.80
CHOKO 18HY/60 ma cased 2 for... 1.95
CHOKO Dual 2 HY/300ma Cased \$1.25 2 for 1.95
CHOKO 6HY/150ma 75ohms Cased 2 for... 2.30
TRANSF 115V/60c 3200VCT/780VCT/200 ma 13.95
115V/60c, 1350VCT/150ma, 6.3V/2A, 3V/2A 7.50
TR 115V/60CY, 7.5VCT/5.5A, 6.3VCT/3A, 3.75
AUDIO INTERSTAGE PP/P TO PP/C UTC... 1.89
CW3 RECEIVER RELAY RACK MFG 3 1/2"x10"
FIXED TUNED XTAL SUPERSET USED G.M. RF &
IF 6K8 MIXER, OSC; 6K7 IF, OCS DET & Outpt.
6EN7BFO, 80 RECT, 115V/60CY Pwr. Case, Colls.
Tubes, no metal case converted VFO, complete
with MANUAL & TUBES. SPECIAL... \$13.95

OSCILLOSCOPE 3" KIT INCLUDES
3BP1 TRANSF 115V/60CY PRI, 375
VCT/110ma, 1320V 5V/3A, 2.5V/3.25A
6.3V/2.75A, NEW TUBES 3BP1 CRYSTAL
5Y3GT RECT, 2V3G RECT CONDNR,
CHOKO, LOW & HV SUPPLY... \$16.95
TEST SET CRYSTAL RECTIFIERS
TS-268/U CHECKS IN21, 23, 23A, 21A,
23B, 21B & OTHERS WITH WESTON
ENGLISH READING IMA MTR COM-
PLETE IN CASE METAL CASE &
HANDLE NEW GTD WITH NAVY MAN-
UAL & SPARE PARTS (G'Cost \$125)... 15.95
ANTENNA SCM50/18ft with ins base... 4.95
ANTENNA 30CM/ATS & PL259... .97
ANTENNA AN/308-SWIVELED 30-3/4"... .97
ANT Collapsible Telescope 12 to 9"... 1.49
ANT SCM50/39 1/2 Long 12 for... 1.00
NICA .004mf/3000WKG. 2 for... 1.00

ADDITIONAL SET OF SPARE TUBES 4.95
COILS FBACWB WILCOX RCVR 5.1/10MC'S 2.79
HI-IMPEDANCE 10,000 ohm HEADSET 2.95
AS WE 809 with 8 ft molded cord & plug 2.95
IF STRIP 80mc/85DB gain mfgd by GAL-
VIN for GEARW, CONTACTS 8/8AK5 & 1 x
1/6AL5 tubes, compact 2 1/2"x10 1/2"x3 1/2"
Hgt outpt Jack & CO-AXIAL Inpt plug... 9.49
SAME STRIP LESS TUBES... 3.49
AUTOSYN BENDIX AY-1 & AY-5 Full In-
dicators 18 to 24V AC 60 to 400cy op
1 1/2 Per pair, GTD... 3.95
Constant Impedance ROTARY BEAM COUPLER
ANTENNA STAKE METAL FOR GUY WIRES
12 for... 1.00

GYRO SERVO UNIT
BENDIX 12,800 'B
HORIZONTAL STABIL-
IZER G'Cost NAVY
1800' SCHOOLS COL-
LEGES, LABS, AMA-
TEURS, EXP'S. AN OP-
PORTUNITY TO HAVE
A GYRO UNIT FOR
YOUR WORK SHOP -
ADAPTABLE FOR
MODEL PLANES, ROCK-
ETS & REMOTE MECH-
ANISMS. WGT. 12
lbs, 10"x6"x7" "TAB"
SPECIAL... \$14.99
ANTENNA FMT IN-
ULATOR 2 1/2" D & 6"
RAD, CER. 2 for 5.98
SYLVAN 2 1/2" x 1 1/4" CRYSTAL
\$1.30 @ Two for
\$2.40
ANTENNA PARABOLIC
RADAR ASSEMBLY 2 1/2"
Dia. DRIVE & SELSYN
MOTORS. Wave guide
coupler & ROTARY
JOINT. Including collar
for mkr 360 Dcz Heriz
Controls & adj Verbal
(S1200) \$29.50
50MMF/20000V JEN-
NINGS VCO 6 1/2" x 2 1/2"
D (LIST \$18)
"TAB" SPECIAL \$6.05
2 for... \$12.95

\$2 Min. order FOB N.Y.C. Add Postage all orders
and 25% deposit Worth 2-230. Send for catalog
99 Specials International Export, School, Col-
lege & Industrial trade. Moneyback "TAB" Guar-
antee.



LEADING NATIONALLY ADVERTISED Precision Wire Wound RESISTORS

For Meters, Bridges, Amplifiers

	10% (REST 1%)	4000	4300*
1/2%	**5%	2000	7500
1500	5000	5100	17000
10000	15000	100000	30000†
50000	75000	466750	47000
51000	147000	850000†	95000
229000	250000†		130000
			201000

"TAB" SPECIAL 3 for \$1.00
25000 294000 314000 333500
353500 400000 462800 422000
458000 478000 THREE for \$1.50
500000 600000 700000 3 for \$1.95
1 MEGOHM 1% accy THREE... \$2.10
10Meg Ten KV MEGOMAX MFA1... 1.73
12Meg 12KV MEGOMAX MFA1... 1.93
WVWZ 1% MFA1 (Sealed Navy Resistors
\$2.20 one megohm 1.69
WRITE FOR OTHER SIZES FROM STOCK
GE Meter 2 1/2" B'C O.c. milliamp... \$2.85
GE Meter 2 1/2" B'C Five amp B'C... 3.50
1 ma. MTR 2 1/2" B'C... 2.93
5 Amp RF MTR 2 1/2" B'C... 3.00
1 Amp RF MTR 2 1/2" B'C... 3.50

OIL CONDERS
10mf/600WVDC \$1.25 2mf/2000WV... 2.15
20mf/600WV... 2.42 3mf/2000WV... 2.80
6mf/1800WV... 2.25 2mf/3000WV... 3.80
15mf/1000WV... 2.53 4mf/3000WV... 5.00
VACUUM CONDNR 100MMF/7500V... 4.95
VACUUM CONDNR 50MMF/7500V... 4.95
VACUUM CONDNR 50MMF/2000V... 6.50

2mf/5000 WVDC CD Dykanol 2 for... 14.50
4mf/5000WVDC \$4: 2mf/12500WVDC... 25.00
4mf/5500WVDC \$8: 1mf/25000WVDC... 75.00
8mf/600VAC/2000WVDC GE PYRANOL... 2.95
3mf/330VAC/1000WVDC GE PYRANOL... 1.25
4mf/330VAC/1000WVDC. CD Dykanol 2 for 2.98
TRANSF WE Cased 115V/60c, 1540V/240ma
115V/60c/240ma SPECIAL TUBE for... 8.95
STROBOFLASH CONDNR 32mf/600VAC/2000
WVDC GE FOUR SECTION 8mf... 7.95
STROBO FLASH TRANSF 1540V Pri 115V/... 4.95

VOLTAGE REGULATOR RAYTHEON
NEW S.C. Cased ADI-V TAPS, INPT
95-130V, OUTPT 115V 58AMPS DNE
% regulation/90%PF WT 20 lbs 6-1/2"
"HxB/Lx4-3/4" "TAB" SPECIAL... \$14.95
GROMMETS KIT ASSTD 200 for... 1.00
CONDENSER KIT SILVER&MICA
UNITS, 50 for... 2.50
CONTROL KIT 50-2MEG OHMS POTS;
10 for... 2.50
RESISTOR KIT 1/2 & 1Watt 50x20mf
ohms, 100 for... 2.50
VITREOUS RESISTOR KIT W.W. 20for
SOCKET KIT 25 ASSTD OCTAL,
LOCTAL, etc... 2.35
POWER RHEOSTAT KIT 25&50Watt
Six for... 4.95
ROTARY SWITCH KIT, SIX for... 1.75

VEEDER ROOT COUNTER 3 DIGIT... 50
VEEDER ROOT COUNTER 4 DIGIT... 75
BRUSH KIT MOTOR ASSTD 100 for... 1.00
CIRCUIT BREAKERS HEINEMANN JAMP... 1.25
CIRCUIT BREAKERS HEINEMANN 10AMP... 1.25
CKT BREAKER KLIXON 60AMP... .89
KNOB KIT ASSTD WITH BUSHINGS, 25 for \$1.25
GR VARIAC 200C/1860Watt NEW... 14.95
TRANSTAT 88/132V/18.2AMP/110V INPT. 29.50
NAVY SP7 SYNCHROSCOPE COMPLETE... 59.80
RELAY TIME DELAY 115/10AMP TACKDC... 1.49
FOXBORO MECHANICAL RFCORDER WITH
110V/60CY Graphic pen-chart mechanism
& CAMS-CASED NEW GTD \$200 COST... 39.50
RM-55 REMOTE CONTROL FOR
XMITTER, CASED, MANUALS, ETC... 3.47
WESTON ANALYZER OAK CASE 8 1/4" SQ-2... 4.50
EXT. CORD HV Duty SJ Male fem plug 10 ft... 1.00
SOCKET AMPHENOL 78ST, 25 for... 1.50

RCA 808 JAN-CRC New Gtd \$1.
7.5V/4amp, plate 1500V/200 watt's
Rated 140 watts output each "UH"
Line \$7.75 "TAB" price \$2.75 &
Two for \$5, with sockets & caps
\$5.40

2AP1 JAN GTD... \$2.21
5BP1 or 5CP1 GTD... 3.95
3BP4 & SOCKET GTD... 6.95
3BP1 & SOCKET GTD... 2.99
2C28 GTD UHP 2 for... 1.50
1695 (S/807) 2 for... 1.30
645 & SOCKETS 2 for... 6.95
815 GTD \$2.23, 2 for... 4.39
829B/3228 2 for... 2.90
807 GTD Two for... 1.90
304TL GTD Two for... 7.81
448A/2C40 Lighthouse tube
@ \$2.00, Two for \$4.00
866A & SOCKETS 2 for \$2; 872A & SOCKETS
2 for... 5.75
954 GTD 80... Five for... 2.00
955 GTD, Two for... 1.50
986, 957, 958A, 059 & SOCKET each... .90
3124 HV RECTIFIER 20000V/60ma... 4.95
2V3G JAN HV RECT 1050V, 2 for... 1.50
6AG5 Boxed New JAN @ 81c, Five for... 3.79
2050, 2X2, RK60/1841, 6SL7, 1E7G each
WE 030 & 329A UHF Diodes New... 8.95
6V8/70c: 6SN7-12SA7/81c: 6SA7/61c
6BB9/81.15 6H6/65c: 6J5M/55c: 5Y3GT-
90/41c: 8A4/75c: 6AL5/81c: 6C8/51-
6F7/51: 6K7/66c: 6K8/61c: 6AC7/185c
JAN New Gtd @ 90c each: Two for... 1.60
35L8, 50L8, 35Z5, 12SQ7, 12SH7, Two for 1.60
6AR5 JAN NEW GTD & 95c, Five for... 4.45
866A COMBINATION TUBES, SOCKETS,
TRANSFORMER, CAPS, GTD... 7.00
872A TUBES, SOCKETS, TRANSFORMER,
CAPS, GTD... 12.00

"TAB" • Dept. 6RC, 6 Church St., New York 6, N. Y., U. S. A. • "TAB"
★ ★ ★ ★ CORNER CHURCH AND LIBERTY STS., ROOM 200 ★ ★ ★ ★

NEWARK VALUES LEAD THE FIELD

NEW EDWARDS 8-Tube FM TUNER



Easily attached to AM receiver or Phono Amplifier for complete High Fidelity reception—87.5 to 109 FM reception—Extremely compact, mc. efficient. Uses 6AG7, 6BE6, 3-6SH7, 6AL5, 6V5, 7Y4. Top quality. Wgt. 10 lbs. Complete with Tubes.....

\$52.50



5-TUBE SUPERHET AC-DC KIT

Full-sized 5 Tube SuperHet Kit with Automatic Volume Control, Built-In Antenna, PM Dynamic Speaker, Brown Plastic Cabinet. Build it yourself and enjoy fine performance! Uses 12SA7, 12SK7, 12SQ7, 50L6, 35Z5. For 110 volt AC or DC. Complete, less tubes.....

\$12.75

Complete Kit of Tubes (as above).....**\$4.08**



3 TUBE AC-DC KIT

Great fun to build and enjoy. Gets all stations from 550 to 1500 kc. 110 volts AC or DC. Uses 2-6J5 and 1-6SJ7 Tubes. Complete kit, less tubes, wire, solder, and phones, only.....

\$6.15

3 Tubes, \$2.40
Phones, \$1.95

PHONO AMPLIFIER

2-Tube Model Compact, mts. any position. Tone, volume controls. 35Z5, 50L6. 110 V. AC. DC. Wired, ready to operate, less tubes.....

\$2.95

3-Tube Model—Similar, uses 35Z5, 12SK7, 50L6. Less tubes.....

\$4.45

3 Tubes for above.....**\$2.54**

PHONO Oscillator

2-Tube Kit Compact, mts. any. where. 110 V. AC-DC. Incl. 2 tubes.....

\$5.33

V M MIXER CHANGER

Sensational! Plays 10" and 12" records—intermixed with no adjustment. Light, crystal pickup. One control knob for on, off, manual, automatic, press to reject. 110 Volt, 60 cycle, noiseless motor. 15 x 14 x 7 7/8" H. Wgt. 16 lbs. Only.....

\$17.95

12-20 Watt PHONO AMPLIFIER

High Fidelity Phono Amplifier for quality reproduction. Matched components. Minimum distortion. Uses 2-7F7, 2-6V6GT, 5Y3GT. Separate tone equalizers. 12 x 6 x 8 1/2". Wgt. 18 lbs. Incl. cover, less tubes.....

\$36.75

Kit of matched tubes.....**\$4.95**

TRANSMITTING and SPECIAL PURPOSE TUBES

2AP1	\$2.25	10Y	1.50	800	2.25	815	2.25	843	.75	955	.75	1629	.27
3AP1	3.00	OC3/VR103	.75	802	1.58	816	.60	845W	3.75	956	.75	2051	.90
2C40	2.63	OD3/VR150	.75	803	9.00	826	2.25	872A	2.25	957	.75	8005	3.15
2C44	1.50	75T	2.25	805	3.75	829B	3.00	874	1.95	958A	.75	8016	.53
2X2/879	.90	211	1.13	807	.95	830B	5.25	884	.75	959	.75	8025A	3.90
SAP1	9.00	250TH	9.00	808	3.00	832A	2.25	922	.68	1616	3.00	9001	.90
5CP1	6.00	304TH	12.00	809	1.50	836	1.50	923	.45	1619	.75	9002	.90
6AK5	.90	304TL	3.75	811	1.95	837	3.38	927	.95	1624	.90	9003	.95
3E29	3.00	801A/801	1.73	813	6.75	838	3.75	931A	1.88	1625	.75	9004	.90
				814	4.50	841	1.20	954	.75	1626	.60	9006	.68



Sig. Corps PHONES

New, Guaranteed! 8000 ohms Imped. Bakelite caps and shells, rubber cushions. Adjustable headband.

Model HS-23, \$1.95

Model HS-33, Same, but low impedance. Sale Price \$1.89

ORDER FROM New York or Chicago INCLUDE POSTAGE 20% Deposit Required with C.O.D. Orders Send Full Amount of Order—Save C.O.D. Chgs. Prices Subj. to Change

HALLICRAFTERS
S-38 complete..... \$47.50
S-40A complete..... 89.50
SX-42..... 275.00

HAMMARLUND
HQ-129X complete... 173.25
SP-400X complete... 342.00
RME-45 complete... 198.70
RME-84 complete... 98.70
Panadaptor..... 99.75
Meek Transmitter... 150.00
Jones Micromatch... 29.50

Standard Receivers Now Available

NATIONAL
NC-173 w/speaker..... 189.50
NRO-501 complete... 306.71
NC-240D complete... 241.44
NC-46 w/speaker... 107.40
1-10A with tubes, less speaker and power supply..... 67.50

NEW YORK Offices & Warehouse 242 W. 55th St., N.Y. 19

NEWARK ELECTRIC COMPANY, INC.

CHICAGO 323 W. Madison St. Chicago 6, Ill.

New York City Stores: 115-17 W. 45th St. & 212 Fulton St.

EASY TO LEARN CODE

It is easy to learn or increase speed with an Instructograph Code Teacher. Affords the quickest and most practical method yet developed. For beginners or advanced students. Available tapes from beginner's alphabet to typical messages on all subjects. Speed range 5 to 40 WPM. Always ready—no QRM.

ENDORSED BY THOUSANDS!

The Instructograph Code Teacher literally takes the place of an operator-instructor and enables anyone to learn and master code without further assistance. Thousands of successful operators have "acquired the code" with the Instructograph System. Write today for convenient rental and purchase plans.

INSTRUCTOGRAPH COMPANY

4701 Sheridan Rd., Dept. RC, Chicago 40, Ill.



AMAZING NEW RADIO!

Pocket or Purse size SMALL AS A PACK OF CIGARETTES! Weighs only a few ounces—Beautiful black chrome plastic case—Uses new crystal diode, H-Q slide dial. No tubes, batteries or electric "plug-ins" required! Receives local broadcasts and

GUARANTEED TO PLAY when used according to instructions sent with each radio! You can use it at home, in many offices, hotels, cabins, in bed, etc.—lots of fun—real entertainment!

Send Only \$100 (cash, money order, check) and pay postman \$2.99 plus delivery fees on arrival or send \$3.99 for postpaid delivery. Complete as shown ready to play with self contained personal phone. For Gift—children will love it—grown-ups too! An exceptional value—order yours and enjoy the many good radio programs coming! Don't be without your Pa-Kette Radio another day! (All foreign orders \$5.00 U.S. cash.) Pa-Kette Electric Co. Dept. RC-6 Kearney, Nebraska

INTERMITTENT ALARM

(Continued from page 73)

are due to receiving conditions or location. Many chronic complaints can be stopped in this way by a demonstration to the customer in the shop.

Audio amplifiers may be tested for stability over long intervals, without having to stand by and observe them audibly. FM or television sets also may be checked by simply injecting the proper type of voltage from a generating device, and connecting the Signalometer across the audio output.

Fading troubles may be isolated also in the stages where the defect occurs unless the defect reflects back into the last audio, such as power supply breakdown. However, for isolating components such as intermittent grid resistors, coupling condensers that open, or catching a thermostatic filament, it is ideal. When isolating intermittent troubles in separate stages, the signal generator should be applied to the individual stages separately. Much valuable time may be saved in this way. Simply hook up the Signalometer, let it play *silently*, and attend to something else! The small investment in material will be repaid many times, plus the satisfaction of knowing that the job left the shop in a healthy condition.

FM AND ALTITUDE

(Continued from page 17)

There seems to be another much cheaper way of gaining high altitude for FM transmitters—and that is captive balloons of the type which were used in England and elsewhere to snag enemy bombers during World War II. The transmitters would be attached directly underneath the balloon in a sort of gondola, thus doing away with excessively long r.f. transmission lines.

Such captive balloons are comparatively cheap, if compared to expensive towers. They are fairly steady and do not sway too much, even under high winds. If these balloons are filled with nonexplosive helium, they do not become dangerous because this gas cannot burn. A pair of captive balloons can be used for transmitters which are on the air 24 hours daily, so that while one is aloft, the other is on the ground for repairs, reconditioning, etc. The upkeep should not be overexpensive, and by having spare balloons on hand, continuous operation of FM stations would be assured. Naturally, such balloons would not be used everywhere in the country, but only in certain localities and only under those conditions where their use might be warranted.

Semi-public television is so popular that one manufacturer (United States Television Corp.) is channelling the larger part of its production into models especially intended for use in taverns, hotels and clubs.

Radio Thirty-Five Years Ago

In Gernsback Publications

HUGO GERNSBACK

Founder

Modern Electrics	1908
Electrical Experimenter	1913
Radio News	1919
Science & Invention	1920
Radio-Craft	1929
Short-Wave Craft	1930
Wireless Association of America	1908

Some of the larger libraries in the country still have copies of **ELECTRICAL EXPERIMENTER** on file for interested readers.

From June, 1913 **ELECTRICAL EXPERIMENTER**

Treatise on Wireless Telegraphy
by *Hugo Gernsback*

Curious Electrical Rocker

How to Construct a One-Quarter KW
Wireless Transformer

Recent Developments by the Federal
Telegraph Company

by *Lee de Forest, Ph.D.*

How to Construct an Oscillation Trans-
former by *S. W. Hector*

3407 Wireless Licenses

Control by Wireless

Quench Spark Gaps

Aerial Problem

SOCKET SUBSTITUTE

While constructing a signal tracer probe around a 9006 u.h.f. diode, I found that the available sockets for the tube were much too large to fit into the probe that I had in mind. I learned—the hard way—that it does not pay to solder directly to the tube pins.

An excellent connection that takes up very little space can be made by wrapping about six turns of No. 24 bare wire around a straight piece of No. 18 wire. This will form a small coil with an inside diameter slightly smaller than the diameter of a miniature tube pin.

When the coil is placed over the pin of a tube, it makes a firm connection without damaging the tubes. Soldered connections are made to one end of the coil.

CHARLES J. APPLGATE,
Champaign, Ill.

The HOUSE OF A MILLION RADIO PARTS

SPECIAL DEALS for RADIO DEALERS and SERVICEMEN

Kit No. 85—Heavy Duty Rim Drive Motor and Turntable.....List \$ 9.95
Crystal Pickup.....List 6.50
Waterfall Walnut Open Case.....List 4.95
1 Mex. Vol. Control with Switch.....List 1.50
1 six-foot AC Cord.....List .40

Kit Total List.....\$23.30
Your Cost only.....**\$11.85**

Kit No. 87—3 Tube Amplifier Kit complete with tubes and instructions—amount to build \$5.73
Kit No. 88—Above amplifier completely wired \$8.70
Kit No. 89—6 inch P. M. Speaker.....1.95

Thousands of radio and sound equipment parts and supplies. Tubes, record changers, amplifiers, speakers, etc. Write for Catalog No. 30

Lifetime SOUND EQUIPMENT CO.
911-913 Jefferson Ave., TOLEDO 2, OHIO

TOP BUYS!

U.S. GOVERNMENT SURPLUS ELECTRON TUBES

Type	Your Cost	Type	Your Cost	Type	Your Cost	Type	Your Cost
3AP1	\$2.95	12DP7	\$6.95	5Y3	.43	1R5GT	.89
3BP1	2.95	829B	3.50	50L6	.69	1S5GT	.89
5BP1	3.95	6Y6G	.59	0Z4	.69	6SF5	59c
5CP1	3.95	6AK5	.95	6AT6	.49	6V6GT	69c
5FP7	3.95	5U4	.59	12AT6	.49	12SQ7	59c
7BP7	4.95	78	.49	1N5GT	.69	89	49c
9LP7	5.95	12A6	.69	6SJ7	.49	77	49c
304TH	7.95	6K7	.49	12SH7	.49	39-44	49c
				6SS7	.49	2B7	49c

RADIO RECEIVERS

Used, in A-1 Condition Complete With Tubes

BC-454-A; 3-6 mc	\$3.95
BC-453-A; 180-550 kc	\$6.95
BC-455-A; 6-9.1 mc	\$3.95

RADIO TRANSMITTERS

BG-457-A; 4-5.3 mc	\$2.95
BC-458-A; 5.3-7 mc	\$2.95

MODULATOR UNIT

BC-466-A	\$6.95
----------	--------

REMOTE CONTROL BOX

BC-450-A	\$1.95
----------	--------

ARMY AIRCRAFT RECEIVER

Model BC-946-B
Broadcast band from 520 to 1500 Kc. Tube complement: 8-12SK7, 1-12SR7, 1-12A6, 1-12K8. Designed for dynamotor operation, but is easily converted to 110 or 32 volt operation. Has two I.F. stages and three gang condenser. Comes packed in sealed carton complete with tubes and an instruction manual, but less dynamotor. **\$12.95**

IFF RADIO RECEIVERS

Signal Corps, complete with 13 tubes. Model BC-986-A—only	\$9.95
---	--------

MARKER BEACON RECEIVER—AIRCRAFT

Complete with 2 tubes and sensitive relay to control external circuits from received signals. The receiver to control models, open doors from a distance, etc. Special **\$4.95**

COMPLETE 4-TUBE INTERPHONE AMPLIFIER

Comes in an aluminum cabinet, 9 1/4 x 4 1/2 x 5 1/2 inches with two 12SK7 and two 12A6 tubes; also Electric Dynamotor 28DC Volt input and 250 V DC output at 60 MA. Yours for only **\$7.95**

ALL SHIPMENTS F.O.B. CHICAGO. 20% DEPOSIT REQUIRED ON ALL ORDERS DEPT. D

RADIO TRANSMITTER AND RECEIVER APS-13

Light weight air-borne radar system, radio transmitter and receiver APS-13; tube complement: 5-6J6; 9-6AG5; 1-VR105; 2-D21; unit is brand new, complete with tubes, the tubes alone are worth **\$15.00** more than this **LOW PRICE OF ONLY \$6.95**

GLIDE PATH RECEIVER R-89/ARN-5

Slide Path Receiver used in the Instrument Landing System covering the frequency range 332 to 335 mc; complete with the following tubes: 7-6AJ5; 1-12SR7; 2-12SN7; 1-28D7 and including three crystals 6497KC; 6522KC; 6547KC—units are in **\$6.95** A-1 condition for only

ARMY SURPLUS, principal components of radio set SCR-274-N; includes 2 transmitters, 3 receivers, 1 modulator, 4 dynamotors, control box, etc.—original cost over \$600.00. **\$24.95** NOW—complete

SCR-522 TRANSMITTER AND RECEIVER

The standard very-high frequency airborne receiver-transmitter, 100 to 156 megacycles. 4 crystal-controlled channels selected from remote control control box. In excellent condition—**ONLY \$19.95**

SETCHELL CARLSON RADIO RECEIVER BC-1206-C

Designed to receive A-N beam signals, 24-28 vdc, 21.0 watts. Tube complement: 14H7 or 14A7, IF amplifier; 14H7 or 14J7, mixer; 14A7 or 14H7, IF amplifier; 14R7 detector and 1st audio amplifier; 28D7, output amplifier. 195 to 420 Kc. 4" high x 4" wide x 6 1/4" long—wt. 3 lbs. 14 ozs. Used—A-1 condition—**\$4.95** ulously low price of 25c. **BRAND NEW** in original carton. Complete with tubes **\$7.95**

DYNAMOTOR DM 32A

Each **\$1.95**

RADAR OSCILLOSCOPE

Complete with 27 tubes including 5" Cathode Ray Tube—used—each **\$24.95**

RADAR OSCILLOSCOPE

Complete with 29 tubes including 3" Cathode Ray tube—used—each **\$24.95**

ARROW SALES, INC.

59 WEST HUBBARD STREET • CHICAGO 10, ILLINOIS

Telephone: SUPERIOR 5575

ELECTRONIC VOLT-OHMMETER

\$11.85

110 VOLTS AC 20 RANGES
0.5/10/50/100/500/1000/5000
volts DC and AC. 0-1,000,000,000
ohms in six overlapping ranges. Sen-
sitivity; over MILLION OHMS per
VOLT on 5 volt range.

POSTPAID

Complete kit includes all component parts, tubes, punched and drilled chassis and beautifully enameled panel. Easily assembled and wired.

Special slideback circuit developed during war by scientist at the California Institute of Technology gives amazing sensitivity and flexibility while completely eliminating necessity of batteries and expensive meter. Each instrument is individually calibrated. Dial scale over nine inches long!

In addition to performing the usual volt-ohm functions, this instrument easily measures these voltages: SUPERHET OSCILLATOR, AVC, AFC, TRUE GRID BIAS AT THE GRID, BIAS CELLS without affecting the circuit. Measures the exact leakage resistance of INSULATION, TUBES, CONDENSERS. It can be used with a signal generator for SIGNAL TRACING.

STERLING ELECTRONIC COMPANY
166 N. Sierra Bonita Ave., Dept. 2, Pasadena 4, Calif.

500 FORMULAS TO SUCCESS

MANY million dollar firms started with a single formula, for which they paid a big price. Here you have 500—no less—tried and tested formulas, recipes and processes for making things... all at the ridiculously low price of 25c.

Here is your opportunity to start a business with but a few dollars' capital and with undreamed of profits in prospect. You can also use these formulas in your own home to cut household expenses to the bone. Or you can put them to use in your workshop to cut costs as much as 1000%.

Quit paying out many dollars in profits to manufacturers, wholesalers, and dealers, when you can make the same thing yourself for a few cents. It's so easy when you follow our simple instructions.

66 PAGES, 3200 WORDS IN TEXT
Send for "500 FORMULAS AND RECIPES" today. Enclose 25c, that's all! You won't be asked for another cent now or later. Sold on a money-back guarantee.

NATIONAL PLANS COMPANY
P. O. BOX 26 R, STATION N, New York 23, N. Y.

Sweden, with 1,840,000 radios, has the highest rate of radio ownership in Europe.

TUBES

ALL TYPES IN STOCK

STANDARD BRANDS—R. C. A.
SYLVANIA, G. E. ETC.

Minimum Order — 10 Tubes

10 to 25 — 40% off List
26 to 100 — 50% off List
101 to 500 — 50 & 10 off List
501 and over — 60% off List

OUR SPECIALS

CORNELL - DUBILIER - CONDENSERS

20 x 20 — 160V	.45
1S5 — 1T4 — 3S4 — 1R5	.69
25Y5 — same as 25Z5	.59
6AH6 — same as 6AK5	.69
6AK5 — Brand New Western Electric	.89
Acorn Tubes 954-955-950-957	.49
Hearing Aid Tubes 501AX to 509AX	.49
All American Kit 50L6-35Z5-12SA7-12SK7-12SQ7	2.65
Miniature Kit 50B5 - 35W4 - 12BE6 - 12BD6 - 12AT6	2.65

OUR OWN BRAND "COMMERCIAL" TUBE GUARANTEED UNCONDITIONALLY—100% OFF LIST

All Types in Stock 50% off List
MADE BY STANDARD BRAND MANUFACTURER

Write for Catalog



COMMERCIAL RADIO

36 BRATTLE ST., BOSTON 8, MASS.

Department H

Television Receiver Schematics

Get a good picture of how Television Receivers are constructed—simple, easy, low cost. Prepare yourself for a new and lucrative field. 3 different schematics of leading television units—study their construction at home or in your lab during your spare time. Special \$1.65 complete. Also available schematics on BC-348, SCR-522, BC-325, BC-375, SCR-274. Special .75 each or all for \$2.25. Enclose check or money order with order.

ORDER TODAY!

WRITE NOW!

TELEVISION ASSOCIATES

30 Church St. Room 533A New York 6, N. Y.

BUILD 15 RADIOS

Absolutely No Knowledge of
Radio Necessary

You Need No Additional Parts or Tools

36-Page Book Written by Expert Radio Instructors . . . teaches you to Build Radios in a Professional Manner.

You will start with a 1-Tube Receiver—Before you are done with this Kit you will have built 11 Receivers, 1 Public Address System and 3 Transmitters.

The PROGRESSIVE RADIO KIT

is THE ONLY COMPLETE KIT—Contains Everything You Need! Instruction Book, Metal Chassis, Tubes, Radio Parts, Soldering Iron, Cutter Pliers and Screw-driver.

PRICE
\$19⁷⁵

Special FREE OFFER for limited time
time only. FREE Electrical and Radio
Tester with Each Progressive Radio Kit.

Progressive Electronics Co., Dept. RC-2
22 Havemeyer St., Brooklyn 11, N. Y.

Send me the Progressive Radio Kit.

Check or Money Order Inclosed. Postage prepaid.

C.O.D. I will pay postage.

Send for further information.

NAME

ADDRESS

CITY

ZONE

STATE

NOTE: C.O.D. Outside U.S.A.

Output of FM receivers in 1947 will be close to 2,000,000 sets, say manufacturers. By the end of December, however, it is expected that FM receivers will be in production at the rate of 5,000,000 annually.

Communications

RADIO-CRAFT EQUIPMENT IN THE ANTIPODES

Dear Editor:

I have enclosed a photo of a signal tracer that I constructed from the article in the August, 1946, issue of RADIO-CRAFT. Although I made several structural alterations to accommodate the material I had on hand, the instrument worked perfectly from the first.

As you will see from the photo, I added pockets at each end to dispose of the spare leads that are a necessary adjunct to the tracer. Also, instead of having a speaker hole cut, I placed louvers in the front of the cabinet, this to my mind improving the appearance of the article. Also, the pockets on the ends took the high look off the tracer.

I have been a subscriber to your publication for years now, enrolling through a local agent for three years at a time, and always look forward to the arrival of the book with impatience. My father and myself are in partnership in a radio service business, and have made all our test equipment, including an all-wave signal generator, grid-dip meter, and 1,000-volt vacuum-tube voltmeter. The latter is a very elaborate instrument, using a 100-microampere meter. The data on it came from an Australian technical monthly.

Way down here the cost of test equip-

ment is all haywire. When I see the cost of things like 'scopes in America and compare them with the price we

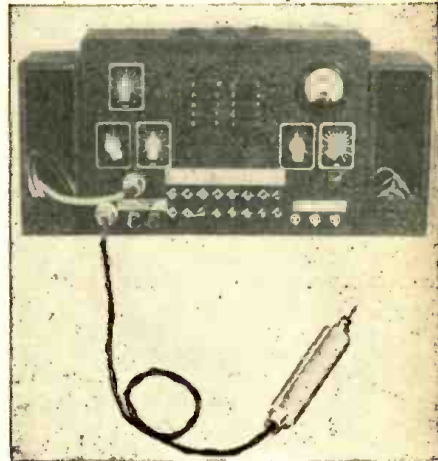

have to pay, I wonder where the difference comes in.

In conclusion, I would like you to congratulate the author of the article referred to, Mr. W. H. Watkins, and show him the photo of my version of his tracer.

K. WOSKETT,
Palmerston, New Zealand

TWO REACTIONS TO THE CRYSTRON CIRCUIT

Dear Editor:

I enjoyed the mendacious adventures of Mohammed Ulysses Fips in your April issue. Maybe he's "got something there."

Hearing aids need a perpetual source of "high" voltage for the voltage-amplifier tubes; and an output tube operating on the voltage of the filament-supply battery! That means a very gassy tube without too much distortion of output current, conditions not easy of attainment.

Put Fips to work on that problem, and a million hard-of-hearers will forever bless him.

Maybe he can combine the Electret and crystal earfone with the output tube; requiring an extremely small, periodic recharge of the Electret, to supply the energy lost in sound-waves from the crystal.

No charge is made for this invaluable suggestion!

LEE DE FOREST,
Guadalajara, Mexico

Dear Editor:

Every year about April first, you editors go off on a binge and come up with some silly monstrosity of an article such as the "New Crystron Lapel Radio" which appeared in the last issue.

Just why the editors of R-C indulge in such childish horseplay is just too much for me, and must be for many of your other readers. I wish the editors of RADIO-CRAFT would grow up!

Why not devote that time, energy and space to a decent article—an extra article of real consequence—an article on some TRUE unusual subject.

Please editors, do be your age. It was one of you editors who remarked in a previous issue that all radiomen are strangely "suspect." I don't argue the point. But do not let us ADVERTISE the fact. And that's exactly what your "FIPS" articles are doing.

P.S.—(But I like you and your mag. anyway.)

E. E. JONES,
Richmond, Va.

RADIO TUBES

Most Critical Types in Stock 50L6, 1A7, 35Z5, etc.

Brand New, in Sealed Cartons
100% GUARANTEED

Repairmen and Dealers. Write For
Available List at Trade Discounts

RADIO-EXPERTS

178 E. 33rd St., Dept. C, Paterson 4, N. J.

A.C. CURRENT ANYWHERE!

With
Katalight Plants and Generators
Furnish the same kind of
Current as the highlines.
Sizes 500 watts to 100 KW.
Also Manufacturers of Rotary
Converters, Frequency
Changers, 32 and 110 Volt
D.C. Motors in 1/4, 1/3 and
1/2 H.P. A.C. Motors, single
phase in 1/2 and 2 H.P.
only.

KATOLIGHT
120 Rock St., Mankato, Minn.

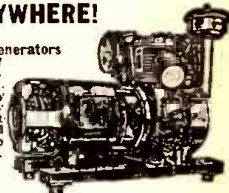

WOULD YOU LIKE A QUIZ?

Dear Editor:

I read with much interest your editorial on generalization before specialization, with its accompanying quiz.

As one of the many individuals who find pleasure experimenting in all branches of science, I observed at once the educational benefits we could obtain from a monthly students' radio quiz. I ask not only for myself, but for all those who wish to acquire a more general knowledge of science, that you include in each issue of RADIO-CRAFT a quiz parallel to that of the March issue.

J. B. GREABLE, JR.
Fredericksburg, Texas

(Possibly some of our regular authors would like to try their hands at a quiz or two?—Editor)

AVOIDS FILING SYSTEMS

Dear Editor:

From time to time I read in RADIO-CRAFT about filing systems, keeping articles separate from advertising, backing up all articles by advertising, etc. I solve my filing problem quite simply.

I cut out the contents page of every issue and keep them all in a loose-leaf book. When I want a particular article, all I have to do is refer to the book with the contents pages, which gives me the date and page number of the article.

H. SILK,
London, England

Facsimile took another step ahead at the recent national convention of publishers. Some 14 newspaper owners placed orders for equipment after seeing it demonstrated, according to reports from Radio Inventions, Inc., which exhibited at the meeting.

LEARN EITHER

ELECTRICITY OR RADIO



In a Few Weeks... in the GREAT SHOPS OF COYNE

Not a "Home-Study" Course

You'll learn fast at COYNE, using actual full-size equipment. Real shop work plus necessary theory. 48 years' success. 2 great Opportunity fields—rush coupon for FREE BOOK on course you prefer. For Veterans and non-veterans.

ELECTRICITY RADIO

Includes Motors, Armature Winding, Industrial and House Wiring, Power Plant Work, Maintenance, both AC and DC. Also new field of Industrial Electronics. Learn to build, shoot trouble on Radios, Public Address Systems, Sound Pictures, FM, Television, Training in Electric Refrigeration included. Send coupon.

FREE BOOK Get big, illustrated book on either course—no obligation. Tells how Coyne helps you.

B. W. COOKE, Dir.,
COYNE ELECTRICAL SCHOOL, Dept. A7-78H
500 S. Paulina St., Chicago 12, Ill.

Send FREE BOOK and full details on course checked:
 ELECTRICITY RADIO

NAME.....
ADDRESS.....
CITY..... STATE.....

Your Choice of 2 Great Fields

June Specials

PORTABLE PHONOGRAPHS

AC-DC and battery portable phonographs, complete with 3 tubes, amplifier, spring wound motor, and battery. Ready to play. Ideal for beach, picnics, etc. **Only \$21.99**



PORTABLE PHONOGRAPH CARRYING CASE

In brown or tan leatherette, built in record holder, size 13"x15 3/4"x7 1/4" **WHILE THEY LAST \$4.95**

DISTRIBUTOR AND SPARK PLUG SUPPRESSORS

18 cents each
10 for..... \$1.50
100 for..... \$12.00

AUTO ANTENNAS

Sturdy, rust proof, 3 section 66" **\$2.13**

ASSORTED COILS

Package of 10 Assorted Coils I.F. Antenna R.E.

WHILE THEY LAST \$1.95 per package

A COMPLETE LINE OF TUBES ARE NOW AVAILABLE

Write for Our Latest Catalogue

RADIO PARTS COMPANY

612 W. Randolph Dept. "C" Chicago 6, Ill.

CHANCELLOR VALUES!

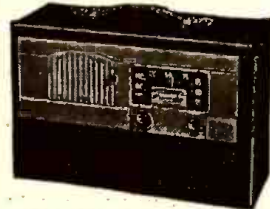

Your Price **\$33.95**
WITH Burgess Battery

Retail value \$42.75

AC-DC-BATTERY PORTABLE DELUXE!

4 tubes plus selenium rectifier. Beautiful simulated alligator case.



Your Price **\$29.45**

Retail value \$39.95

ALL PURPOSE PHONO COMBINATION

Walnut veneer cabinet—Superheterodyne radio—Silent motor—crystal pickup. Beautiful tone!

For quantity prices—write Shipped FOB warehouse—20% deposit, bal. COD.

Free Radionic Catalog



RADIONIC EQUIPMENT COMPANY

TRIBUNE THEATER ENTRANCE DEPT. 106, 170 NASSAU ST., N. Y. 7, N. Y. WORTH 2-0421. CABLE "CHANSLOR"

RADIONIC EQUIPMENT CO. 170 Nassau St., Dept. 106, New York 7, N. Y. Please send me a FREE copy of your 1947 Catalog. I understand it has thousands of items illustrated, described and priced and will be a great help to me in my search for "hard-to-find" radio equipment. CHANCELLOR RADIOS.

Name.....
Address.....
City..... State.....

ALL STANDARD BRANDS

TUBES 50% OFF OPA LIST PRICES

- OUTPUT TRANSFORMERS for 50 L 6 \$.49
 ALLIANCE MOTORS with 9" turntable 2.95
 CRESCENT SPEAKERS, V 5" PM .95
 PICK-UPS SHURE, ASTATIC, WEBSTER } Your Choice, ea. 1.95
 PORTABLE LEATHERETTE CASE to accommodate record changer—A REAL BUY 5.95
 VOLUME CONTROLS with SWITCH—all ohmages in stock .50
 ESICO SOLDERING IRONS—
 65 Watt 1.95
 100 Watt 2.37

25% with order—Balance C.O.D. Send postage with all orders less than \$5.00

CONSOLIDATED RADIO SALES COMPANY
 Wholesale Distributors
 Dept. RC-1, 768 Amsterdam Ave., New York 25, N. Y.

HAM SPECIALS!

- Parabolic Reflectors, 15 inch spun Alum. Alzak Fin. Ideal for 1200 MC \$2.19 ea. and up Original Price \$18.00... \$3.95 dr.
 Butterfly Tuners—80 to 300 Mc. 300 to 1000 Mc. New in cartons \$1.95
 Air Trimmers, 10 asstd \$1.19
 Mica Cond.n.ers, 25 asstd. .98
 Phase Shift Condensers—2 sections, split stator 4-15 mmfd, silver plated .69
 Plate Transformers—Pri. 110V 60 cv. Sec. 1600V CT—250 ma. \$6.95
 Klystron Osc. Tube-2K25/723 AB operates on 8 cm. New in cartons, while they last, each \$5.75

Write for circular

AMERICAN SALES CO.
 1811 West 47th St. Chicago 9, Illinois



Scientifically Built
 Heavy bar magnets greatly increase their efficiency.

CANNON-BALL

Circular R-6 covers complete line of sensitive, clear-tone, dependable Headsets. Get it. Choose the super-quality Headset you like best. Twenty-five years headset specialization insures satisfaction. Write

C. F. CANNON COMPANY
 SPRINGWATER, N. Y.

Headset Headquarters

Do you need BINDING POSTS?



The XL PUSH POST with its Spring Action assures Constant Contact and quick connection. Manufactured in All Aluminum Type M at 15c each. Aluminum Body, Bakelite Top Type M at 15c each. Types CP or NP. ALL BRASS—STAIN-LESS STEEL SPRING & PIN. PROVEN BY 240 HR. SALT SPRAY TEST as NON-CORROSIVE at 28c each.

X. L. RADIO LABORATORIES
 420 West Chicago Ave., Chicago 10, Ill.

INDEX TO ADVERTISERS

Abell Distributing Company 66
 Allied Radio Corporation 46
 George Brodsky Advertising 65
 Almo Radio Company 46
 E. L. Brown Advertising 78
 American Sales Company 13
 American Television, Inc. 13
 Turner Advertising Agency 61
 Amplifier Corporation of America 61
 Sternfield-Godley 75
 Arrow Sales, Inc. 75
 Sander Rodkin Advertising Agency 79
 Audel Publishers 79
 Grant & Wadsworth, Inc. Inside Back Cover
 Bell Telephone Labs. N. W. Ayer & Son 43
 Belltone Radio & Television Corp. 56
 Bady, W. H. 72
 Brady-Parkinson Company 72
 Brooks Radio Distributing Company 72
 Equity Advertising 56
 Bursteln-Appelbee Company 56
 Frank E. Whalen Advertising Company 49
 Buffalo Radio Supply 49
 International Advertising Agency 61
 Buyers' Syndicate 78
 C. F. Cannon 78
 M. J. Werner Advertising 45
 Capitol Radio Engineering Institute 45
 Henry J. Kaufman & Associates 72
 Chief Electronics 15
 The Graphic Company of Advertising 58
 Cleveland Institute of Radio Electronics 8
 Kenneth Kolpein Advertising 76
 Colette Products Company 8
 Rolfe C. Spinning, Inc. 76
 Commercial Radio 76
 The Goulston Company, Inc. 8
 Communications Equipment Co. 51
 Borough Advertising Agency 78
 Concord Radio Corporation 78
 E. H. Brown Advertising Agency 3
 Consolidated Radio Sales Company 77
 Cornell-Dubilier Electric Corporation 44
 Reiss Advertising 67
 Coyne Electrical School 9
 Gordon Best Company, Inc. 44
 Coyne Electrical School 67
 Phil Gordon Advertising Agency 9
 Deer & Taylor 57
 Spencer W. Curtiss Advertising 57
 DeForest's Training Institute 12
 Lauesen & Salomon 70
 Douglas Radio Supply Company 69
 Esse Radio Company 65
 Gary A. Ruben Advertising 39
 G & E Equipment Supply Company 72
 Tronnes & Company 62
 G & G Genuine Majestic Radio Parts Service 61
 Bergman-Jarrett Company 47
 General Cement Mfg. Company 60
 Sander Rodkin Advertising Agency 79
 General Electronic Distributing Company 70
 Bass & Weber Company, Inc. 74
 General Test Equipment Company 2
 Suzanne Hayman Advertising 76
 Globe Distributors 70
 The Goulston Company 62
 Greenwich Sales Company 61
 Weber Associates 47
 Herbach & Rademan, Inc. 60
 Philip Klein Advertising Agency 79
 Hershel Radio Company 70
 Hugh-Allen Company 74
 Highbridge Radio-Television & Appliance Co. 76
 Burke & Wayburne Advertising Agency 70
 Hudson Specialties 74
 Illinois Condenser Company 74
 Roy D. Zeff and Associates 2
 Instructograph Company 76
 Turner Advertising Agency 70
 International Resistance Company 70
 John Falkner Arndt and Company, Inc. 62
 Katolight Co. 66
 Klein Ind. Corp., Manuel 71
 Sternfield-Godley 55
 Lafayette Radio 52
 Reiss Advertising Agency 48
 Leeds Radio Company 71
 Weber Associates 55
 Legri S Company 75
 William H. Rankin Advertising 52
 Leotone Radio Corporation 48
 Altomari Advertising Agency 52
 Lifetime Sound Equipment Company 52
 The Miller Agency Company 52
 McGee Radio Company 48
 Westgate Advertising Co. 52
 McMurdo Silver Company 48
 Edward Owen & Company 48
 P. R. Mallory & Co., Inc. Back Cover
 Aitkin-Kynett Company 56
 Magna-Metal Products Company 68
 Equity Advertising Agency 42
 Maritime Switchboard 42
 Metropolitan Electronic & Instrument Co. 54, 59
 Bass & Weber, Co., Inc. 75
 Murray Hill Books Company 75
 Harry P. Bridge Advertising 75
 National Plans Institute 1
 National Radio Institute 1
 Van Sant, Dugdale & Co.

National Schools 11
 The Mayers Company 74
 Newark Electric Company, Inc. 68
 The Charles Brunelle Company 67
 Niagara Radio Supply 67
 Burke and Wayburne 63
 Olson Radio Warehouse 74
 Jessop Advertising 70
 Opportunity Adlets 76
 Pa-Ketta Radio Company 70
 Arrow Advertising 76
 Precision Apparatus Company 76
 Shappe-Wilkes, Inc. 76
 Progressive Electronics Company 76
 Thomson, Seva and Valenti, Inc.

RADIO SCHOOL DIRECTORY
 (See Page 80)

American Radio Institute 58
 Sternfield-Godley, Inc. 53
 Baltimore Technical Institute 6
 Candler System Company 72
 Rand-Ries Advertising 76
 Commercial Radio Institute 56
 Don Martin School of Radio Arts 77
 Electronics Institute, Inc. 77
 Hollywood Sound Institute 78
 Nelson Advertising Service 14
 Lincoln Engineering School 78
 Melville Radio Institute 14
 Milwaukee School of Engineering 69
 RCA Institutes 44
 Radcraft Publications 55
 Radio Center 5
 Claude E. Whipple Advertising 72
 Radio Corporation of America 76
 J. Walter Thompson Advertising 76
 Radio Dealers Supply Company 76
 Burke and Wayburne 76
 Radio Experts 56
 Radio Kits Company 77
 Hamburger Agency 77
 Radionic Equipment Company 78
 Republic Advertising Agency 78
 Radio Parts Company 14
 Sydney S. Lovitt Advertising 78
 Radio Publications 14
 Radio Supply and Engineering Company 69
 Karl G. Behr Advertising Agency 44
 Radolok Company 55
 Turner Company 56
 Ray-Lectron Company 56
 Malcolm Severance Company 55
 Reed Manufacturing Company 56
 Borg Advertising Agency 5
 Reliance Merchandising Company 61
 Howard W. Sams and Company, Inc. 71
 Aitken-Kynett Company 41
 Walter L. Schott Company 73
 Ross, Gardner & White 16
 Senco Radio, Inc. 7
 Sternfield-Godley 75
 Sprague Products Company 69
 Harry P. Bridge Company 75
 Sprayberry Academy of Radio 69
 Harry P. Bridge Company 69
 Sterling Electronic Company 41
 Superior Instruments 64
 Bass & Weber Company, Inc. 41
 Supreme Publications 73
 Henry H. Teplitz Advertising 73
 Sylvania Electric Products, Inc. Inside Front Cover
 Newell-Emmett Company 73
 "TAB" Technical Apparatus Bldrs. 76
 Weber Associates 63
 Television Associates 76
 Transvision, Inc. 4
 H. J. Gold Company 64
 Tyler Commercial College 64
 Wm. F. Finn & Assoc. 57
 Variety Electric Company 57
 Bass & Weber Company 78
 Wright, Incorporated 78
 Kay Advertising, Inc. 78
 X. L. Radio Laboratories

Get Started in Radio



10 "HOW-TO-DO-IT" BOOKS
 Get a solid foundation in radio by means of these 10c timely text books. Each clearly written, profusely illustrated, contains over 15,000 words. You'll be amazed at the wealth of information packed into these handy books. Excellent for reference—ideal for technical library. Your money back if not satisfied.

5 BOOKS for 50c
10 BOOKS for \$1.00

Sent to You Postpaid

- No. 1—How To Make Four Decic Short Wave Sets
 No. 2—How To Make The Most Popular All-Wave 1 And 2 Tube Receivers
 No. 3—Alternating Current for Beginners
 No. 4—All About Aerials
 No. 5—Engineer's Radio Dictionary by check or money order—postmaster letter if you send cash or stamps.
 No. 6—How To Have Fun With Radio
 No. 7—How To Read Radio Diagrams
 No. 8—Radio for Beginners
 No. 9—Simple Electrical Experiments
 No. 10—Television

RADIO PUBLICATIONS, 25A West 84th, New York (7)

HARD-TO-GET PARTS

POWERFUL ALL-PURPOSE INDUCTION MOTOR
IDEAL FOR EXPERIMENTERS—101 USES



Sturdily constructed to precision standards, this self-starting shaded pole A.C. induction motor is powerful enough for a number of uses. Some of these are: Automatic Timing Devices, Current Interrupters, Electric Fans, Electric Chimes, Window Displays, Photocell Control Devices, Electric Vibrators, Small Grinders, Buffers and Polishers, Miniature Pumps, Mechanical Models, Sirens, and other applications.

Consumes about 15 watts of power and has a speed of 3,000 r.p.m. When started down, this sturdy unit will constantly operate on 18 lbs. turntable loaded with 200 lbs. dead weight—**THAT'S POWER!**
Dimensions 3 1/2" high by 2" wide by 1 3/4" deep; has 4 convenient mounting studs; shaft is 1/4" long by 3/16" diameter, and runs in self-aligning oil-retaining bearings. Designed for 110-20 volts, 50-80 cycles, A.C. only. Shp. Wt. 2 lbs.
ITEM NO. 147
YOUR PRICE **\$2.95**

ULTRA MAGNET

LIFTS MORE THAN 20 TIMES ITS OWN WEIGHT
LITTLE GIANT MAGNET



Lifts 5 lbs. easily. Weighs 4 oz. Made of ALNICO new high-magnetic steel. Complete with keeper. World's most powerful magnet ever made. This experiment is highly useful and hundreds of excellent uses for this high quality permanent magnet. Measures 1 3/4" x 1 1/2" Shp. Wt. 1/2 lbs.
ITEM NO. 159
YOUR PRICE **\$1.50**

GENUINE MICROPHONE TRANSMITTERS



Regular telephone transmitters taken from a large telephone supply company's overstock. Work perfectly on 2 dry cells. Can be used on P.A. systems, call systems, intercommunications, short-line telephone circuits, home-to-house or room-to-room phone lines, also to talk through your own radio or as concealed dictation machine. Useful replacements on battery-operated rural telephone lines.

THESE ARE GENUINE TRANSMITTERS, MADE BY KELLOGG, WESTERN ELECTRIC AND STROMBERG-CARLSON, excellent in appearance and operation. A remarkable value and one seldom offered in these times. Shp. Wt. 1 lb.
ITEM NO. 160
YOUR PRICE **\$2.10**

AMAZING BLACK LIGHT!!

Powerful 250-Watt Ultra-Violet Source



The best and most practical source of ultra-violet light for general experimental and entertainment use. Makes all fluorescent substances brilliantly luminescent. No transformers of any kind needed. Fits any standard lamp socket. Brings out beautiful opalescent hues in various types of materials. Swell for amateur parties, plays, etc.; to obtain unique picture effects. Bulb only. Shp. Wt. 2 lbs.
ITEM NO. 87
YOUR PRICE **\$1.95**

WESTERN ELECTRIC BREAST MIKE

This is a fine light-weight aircraft carbon microphone. It weighs only 1 lb.

Mike comes with breastplate mounting and has 2-way swiveling adjustment, so that it can be adjusted to any desired position. There are 2 woven straps; one goes around neck, the other around chest. Straps can be snapped on and off quickly by an ingenious arrangement.

This excellent mike can be adapted for home broadcast or private communication systems. By dismounting breastplate, it can be used as a desk mike.

Comes complete with 6-foot cord and hard rubber plug. Finished in sherdarized plastic non-rustable. Shipping weight, 2 lbs.

ITEM 152
YOUR PRICE **\$1.49**

WATTHOUR METER

Completely overhauled and ready for immediate service. Designed for regular 110-volt, 60 cycle 2-wire, C.C. circuit. Simple to install: 2 wires from the line and 2 wires to the load. It is fully constructed in heavy metal case, 8 1/2" high, 8 1/4" wide, 5" deep. Working house, G. E. Ft. Wayne, Sankoma or other available make. Shp. Wt. 14 lbs.

ITEM NO. 33
YOUR PRICE **\$6.95**



HUDSON SPECIALTIES CO.

40 West Broadway, Dept. RC-6-47, New York 7, N. Y.
I have circled below the numbers of the items I'm ordering. My full remittance of \$..... (include shipping charges) is enclosed (NO C.O.D. ORDERS UNLESS ACCOMPANIED WITH A DEPOSIT.) OR my deposit of \$..... is enclosed (20% required), ship order C.O.D. for balance. NO C.O.D. ORDER FOR LESS THAN \$5.00. BE SURE TO INCLUDE SHIPPING CHARGES.
Circle Item No. wanted:
147 159 160 87 152 33

Name
Address
City State

A MINORITY REPORT?

Dear Editor:

I am and have been for some considerable time a regular reader of your magazine RADIO-CRAFT.

My reason for writing to you is my amazement at the article "Transatlantic News" by Major Hallows, in the issue of January of this year.

My job is that of managing a radio business in the heart of London, in Fleet Street. I have been selling, installing, and servicing television receivers since June of last year when the BBC recommenced its transmissions after the wartime break.

Business is of such a magnitude that I am now booking orders for television receivers 18 months ahead. The demand is terrific for receivers of all sizes, from the standard 8- x 6-inch picture to the large 12- x 10-inch type. Prices range from £35 plus tax to £150 plus tax, and the demand is just as great for the smaller-tube type as for the other.

Definition is excellent and in my opinion is quite good enough for this size of screen, and no appreciable benefit would result from the use of 1,000-line transmissions.

Even with the 8- x 6-inch type the viewing distance (optimum) is found to be about 5 feet, so that in the small flats which abound in this town anything much larger is not required and neither could it be used in comfort in most cases.

From the transmitting end the art of the cameraman can be seen to improve daily as they get more practice at this new and very difficult art.

In conclusion, I would like to point out that mine is not at all an unusual case and that if Major Hallows would like to come and see me, or for that matter any other television dealer in London, we should be only too pleased to give him plenty of evidence as to the unmeetable demand for television receivers of all descriptions.

I am

Yours sincerely,
L. A. LEE,
London, England

UNWANTED INVENTION

Dear Editor:

In the "Why Not" item by Elizabeth Rehm in the February issue of RADIO-CRAFT, Miss Rehm says that a telephone which could be used without being held in the hand "would enable a woman to chat and do some mending at the same time." That is probably precisely the reason the telephone companies have not dared touch the idea with a ten-foot pole. Why, that's dynamite to play with! Women do enough "visiting" on the telephone under present conditions. Imagine the confused state of affairs that would exist if they could sit and mend while gossiping on the phone. We men would never get the chance to use it. So please, Bell System, don't toy with the idea!

LONG-SUFFERING MALE,
(Name withheld at writer's request)
Cabin John, Md.

7 DAYS FREE EXAMINATION

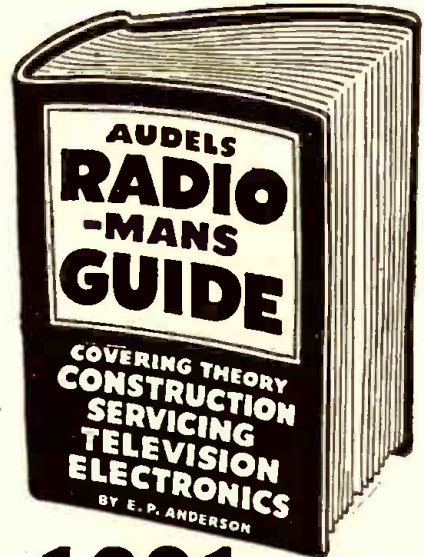

1001 RADIO FACTS AND FIGURES

AUDELS RADIO-MANS GUIDE—914 Pages, 633 Illustrations, Photos, Wiring Diagrams, 38 Big Chapters, covering Radio Theory, Construction, Servicing, including Important Data on Developments in Television, Electronics and Frequency Modulation, Review, Questions and Answers, Calculations & Testing. Highly Endorsed—Indispensable for Ready Reference and Home Study.

\$4 COMPLETE • PAY ONLY \$1 A MONTH
Step up your own skill with the facts and figures of your trade. Audels Mechanics Guides contain Practical Inside Trade Information in a handy form. Fully Illustrated and Easy to Understand. Highly Endorsed. Check the book you want for 7 days' Free Examination.

Send No Money. Nothing to pay postman.

CUT HERE MAIL ORDER

AUDEL, Publishers, 49 W. 23 St., NEW YORK 10, N. Y.

Please send me postpaid for FREE EXAMINATION books marked (x) below, if I decide to keep them I agree to mail \$1 in 7 Days on each book ordered and further mail \$1 monthly on each book until I have paid price. Otherwise, I will return them.

- RADIO-MANS GUIDE, 914 Pages \$4.
- ELECTRICIANS EXAMINATIONS, 250 Pages 1.
- WIRING DIAGRAMS, 210 Pages 1.
- ELECTRICAL DICTIONARY, 9000 Terms 2.
- ELECTRICAL POWER CALCULATIONS, 425 Pgs. 2.
- HANDY BOOK OF ELECTRICITY, 1340 Pages 4.
- ELECTRONIC DEVICES, 216 Pages 2.
- ELECTRIC LIBRARY, 12 vol., 7000 Pgs., \$1.50 vol. 1.
- OIL BURNER GUIDE, 384 Pages 1.
- REFRIGERATION & Air Conditioning, 1280 Pgs. 4.
- POWER PLANT ENGINEERS Guide, 1500 Pages. 4.
- PUMPS, Hydraulics & Air Compressors, 1658 Pgs. 4.
- WELDERS GUIDE, 400 Pages 1.
- BLUE PRINT READING, 416 Pages 2.
- SHEET METAL WORKERS Handy Book, 388 Pgs. 1.
- SHEET METAL PATTERN LAYOUTS, 1100 Pgs. 4.
- AIRCRAFT WORKER, 240 Pages 1.
- MATHEMATICS & CALCULATIONS, 700 Pgs. 2.
- MACHINISTS Handy Book, 1600 Pages 4.
- MECHANICAL Dictionary, 968 Pages 4.
- AUTOMOBILE GUIDE, 1540 Pages 4.
- DIESEL ENGINE MANUAL, 400 Pages 2.
- MARINE ENGINEERS Handy Book, 1280 Pages 4.
- SHIPFITTERS Handy Book, 272 Pages 1.
- MECHANICAL DRAWING COURSE, 160 Pages 1.
- MECHANICAL DRAWING & DESIGN, 480 Pgs. 2.
- MILLWRIGHTS & Mechanics Guide, 1200 Pgs. 4.
- CARPENTERS & Builders Guides (4 vols.) 6.
- PLUMBERS & Steamfitters Guides (4 vols.) 6.
- MASONS & Builders Guides (4 vols.) 6.
- MASTER PAINTER & DECORATOR, 320 Pgs. 2.
- GARDENERS & GROWERS GUIDES (4 vols.) 6.
- ENGINEERS and Mechanics Guides
Nos. 1, 2, 3, 4, 5, 6, 7 and 8 complete 12.
- Answers on Practical ENGINEERING 1.
- ENGINEERS & FIREMANS EXAMINATIONS 1.

Name
Address
Occupation
Employed by R.C.F.

RADIO SCHOOL DIRECTORY

PREPARE NOW FOR SKILLED JOBS IN RADIO AND ELECTRONICS

CAREERS in RADIO

INTENSIVE COURSES—Thorough, technical education for progressive men and women.

1. **RADIO TECHNICIAN**—The MRI General Course. Includes F.M. & Television. Prepares for FCC Broadcast Licenses.
2. **RADIO & TELEVISION SERVICING**—Prepares for employment as Repairman on Standard Broadcast, F.M. & Television Receivers.
3. **RADIO COMMUNICATIONS**—Prepares for FCC Operators' License. Leads to position as Merchant Marine or Flight Radio Officer, Commercial Operator.
4. **FUNDAMENTAL RADIO MATHEMATICS**—The MRI Preparatory Course. Required pre-training for students lacking a basic mathematical background.

MELVILLE RADIO INSTITUTE
45 W. 45th St., N. Y. 19, BR 9-5080

"The Radio School Managed By Radio Men"

Licensed by the State of New York

MELVILLE RADIO INSTITUTE

45 West 45th St., New York 19, N. Y.

GENTLEMEN: RC

Send me FREE information about your school.

Name:

Address:

MAIL THIS COUPON NOW

RADIO-TELEVISION TECHNICIAN'S COURSE

- New Classes starting every 5 weeks. Immediate Enrollment.
- Women Students invited.
- Approved for veterans.

Write for Free Bulletin on Courses

HOLLYWOOD SOUND INSTITUTE, Inc.

1040 N. Kenmore Ave., Los Angeles

Dept. B

MO I-2345

LEARN

TELEVISION ELECTRONICS • RADIO

Modern Completely Equipped Laboratories

DAY AND EVENING CLASSES

G.I. APPROVED. Veterans Receive Subsistence

ENROLL NOW

ELECTRONICS INSTITUTE, INC.

21 Henry

Detroit 1, Mich.

COMMERCIAL RADIO INSTITUTE

A radio training center for twenty-six years.

RESIDENT COURSES ONLY

Broadcast, Service, Aeronautical, Television and Marine telegraphy classes; Preparatory Course now forming. Literature upon request. Veteran training. Classes now forming for July 1st. Entrance examination June 16.

Dept. C, 38 West Biddle St., Baltimore 1, Md.



Be a "key" man. Learn how to send and receive messages in code by telegraph and radio. Commerce needs thousands of men for jobs. Good pay, adventure, interesting work. Learn at home quickly through famous Candler System. Write for FREE BOOK.

CANDLER SYSTEM CO.
Dept. 3-G, Box 928, Denver 1, Colo., U.S.A.

CORRESPONDENCE COURSES IN RADIO and ELECTRICAL ENGINEERING

ELECTRICAL ENGINEERING Get good grasp of wide electrical field. Prepare yourself at Low Cost, for secure future. Modern course. So simplified anyone can understand quickly.

RADIO ENGINEERING Extra fine course in radio, public address, photo-electric work. Trains you to be super-service man. Real vacuum-tube technician. Servicemen needed badly. Diploma on completion. Many graduates earning big pay.

Send postcard for Free Copies of school catalog, full details, all about deferred payment plan, experimental kits, etc. **\$25** Either

WRITE Lincoln Engineering School, Box 931C-100, Lincoln 2, Nebr.

LEARN

RADIO

IN ONLY 34 WEEKS

Get F. C. C. LICENSE or complete RADIO REPAIRING

TELEVISION—1 Year

Classes Start Every Month

Our Organization Engaged in TECHNICAL TRAINING for 27 Years

BALTIMORE TECHNICAL INSTITUTE
1425 Eutaw Place, Balt. 17, Md.



RCA INSTITUTES, Inc.

Offer thorough training courses in all technical phases of

Radio and Television

DAYS—EVENINGS WEEKLY RATES

VETERANS: RCA Institutes is approved under G. I. Bill of Rights

For Free Catalog Write Dept. RC-47

RCA INSTITUTES, Inc.

A Service of Radio Corporation of America
75 VARICK STREET NEW YORK 13, N. Y.

SOUND RECORDING SCHOOL

A practical 9 months' course in Sound Fundamentals, Recording, and Sound Transmission measurements; in a laboratory containing transmission sets, oscillators, square wave generator and intermodulation analyzer, and other equipment.

Two complete recording studios assimilating broadcast, motion picture and commercial sound recording, under the direction of H. M. Tremaine.

Approved for Veterans
DON MARTIN SCHOOL OF RADIO ARTS
1655 Cherokee St., Hollywood, Calif.

RADIO

TECHNICIAN and RADIO SERVICE COURSES
FM and TELEVISION

AMERICAN RADIO INSTITUTE

101 West 63rd St., New York 23, New York

Approved Under GI Bill of Rights

Licensed by New York State

BOOK REVIEWS

DIRECTIONAL ANTENNAS, by Carl E. Smith, E.E. Published by Cleveland Institute of Radio Electronics, Cleveland, Ohio. Loose-leaf style, flexible leatherette covers, 8 1/2 x 11 inches, over 300 pages. Price \$15.00 (2 copies \$25.00).

This book is complete with charts, illustrative patterns, definitions, and equations.

Part I derives the characteristics of reference antennas (spherical, half-wave, quarter-wave, 0.311 vertical, and others) from those of an "infinitesimal" radiator. Design equations for field shape and strength of the several types are developed from basic considerations. The method is clear and concise, and not too demanding, so it is suitable for technical student as well as engineer.

Part II contains over 500 actual field patterns obtained from two towers spaced up to 4 wave lengths and phased up to 180 degrees (in steps of 15 degrees). Almost 15,000 actual patterns obtained from 3-element arrays are shown in Part III. Each page contains 64 patterns associated with a given placement of the radiators, the 8 rows and 8 columns corresponding to the phasing (up to 360 degrees in steps of 45 degrees) of two of the towers relative to the third. A special feature of these sections is the method used to designate each pattern by a definite number to indicate directly the phase, orientation, and distance of the towers. These patterns were originally drawn by an electro-mechanical calculator which was designed, built, and patented by the author and his associates.—I. Q.

MORE COLOR TELEVISION

A new television invention reported last month from the West Coast may make possible 3-color television with a single electronic image tube.

The system is the invention of George E. Sleeper, chief engineer of Color Television, Inc.

It employs a scanning device which converts filtered colors into a single picture at the transmitter, using a single electronic picture tube. The images are reproduced in a group in black and white on the receiving picture tube and then projected through filters and combined optically and projected to a screen as a color picture.

A feature of the system, it is pointed out, is that it is receivable on both sets equipped for color and those producing only monochrome images.

PRACTICAL TECHNICAL TRAINING FOR YOU

Specialize in Electronics, Radio, Electricity, Refrigeration, Heating and Air Conditioning, or Welding. Prepare in one year for position as Technician, or in two additional years secure your B. S. Degree in ELECTRICAL ENGINEERING with major in Machinery or Electronics.

Write for booklet "Career Building"

MILWAUKEE SCHOOL of ENGINEERING

INSTITUTE OF ELECTRONICS
RC-647 N. Broadway and E. State, Milwaukee, Wis.

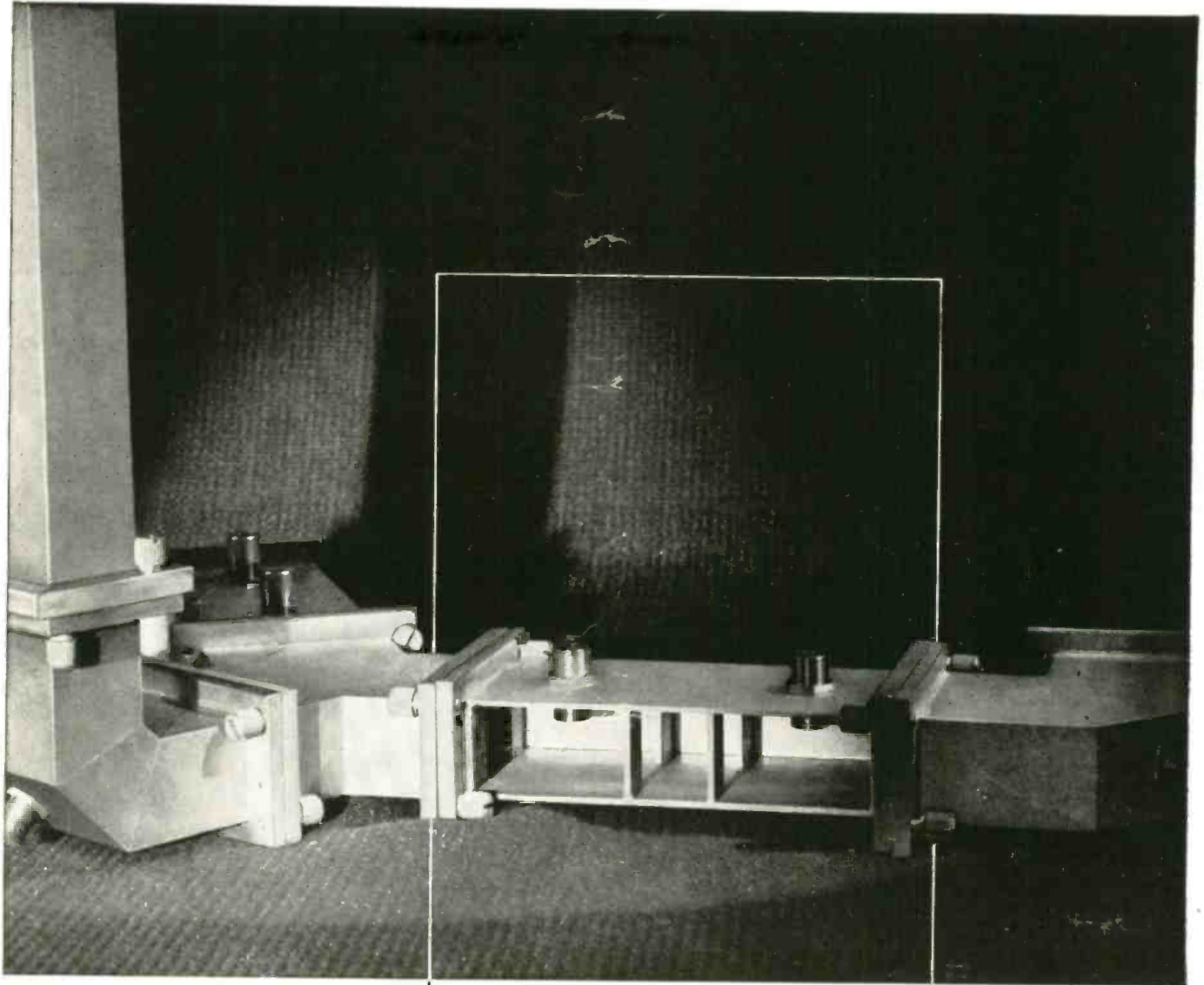

The two filters in the picture (one with side cut away) are used to separate two radio channels coming in on the same antenna but on different frequencies. At the end of the connecting waveguide, the channels are made to part company, each going to a different circuit through its assigned filter.

SEPARATION CENTER FOR RADIO WAVES

Thirty years ago, when all telephone service went by wire, Bell scientists developed means of sending dozens of conversations over the same line.

This they did by giving to each conversation a different carrier frequency; then to separate it from the others, they used a device which they had invented and named—the *electric wave filter*.

Today, in microwave telephone systems, the message-bearing waves pass to and from the antenna in pipes called waveguides. So scientists in Bell

Laboratories devised a different kind of filter—a filter in a waveguide. This filter is a system of electrically resonant cavities formed by walls and partitions. Waves that set up sympathetic vibrations in the cavities pass through; others are reflected.

In the Bell System, now, single circuits are carrying many conversations at the same time through precision wave-filtering.



BELL TELEPHONE LABORATORIES

THE ONLY BOOK OF ITS KIND IN THE WORLD



Has the answers to your questions about vibrator power supply designs...



Basic Vibrator Structures	Examples of Transformer Design
Mallory Standard Vibrator Types	Design Considerations for Other Applications
Selection of Correct Vibrator	High Frequency Vibrator Power Supply
Power Transformer Characteristics	Timing Capacitor Considerations
Typical Vibrator Characteristic Data Sheets	Design Practices and Methods of Interference Elimination
Power Transformer Design	Vibrator Power Supply Circuits
General Procedure in Designing Transformers	Vibrator Inspection Procedures

What do you want to know about vibrators or vibrator power supplies? What kind of problems are you called on to solve? This book gives you the answers to your "why" questions. It will help you to understand the basic principles involved in vibrator power supplies as well as the designing of such equipment.

The information brought you in the Mallory Vibrator Data Book is complete, original and easy to understand. Produced by the country's largest makers of vibrators, it shares with you sixteen years of highly specialized power supply experience—and cannot be duplicated anywhere else. It embodies the same kind of "know how" that Mallory has brought you in such outstanding volumes as the Radio Service Encyclopedia, the Mallory Technical Manual and others.

Although just published, this great new book—the only one of its kind in the world—is already in large demand. Order now before the first edition runs out. See your Mallory Distributor. Price \$1.00.

See Your Mallory Distributor for a free copy of the 1947 Replacement Vibrator Guide

P. R. MALLORY & CO. Inc.
MALLORY

VIBRATORS . . . VIBRAPACKS* . . . CAPACITORS . . .
VOLUME CONTROLS . . . SWITCHES . . . RESISTORS
. . . FILTERS . . . RECTIFIERS . . . POWER SUPPLIES.

*Reg. U.S. Pat. Off.

APPROVED PRECISION PRODUCTS

P. R. MALLORY & CO., Inc., INDIANAPOLIS 6, INDIANA

ADV Plans, LLC

Copyright Notice:

The entire contents of this CD/DVD are copyright 2014 by ADV Plans, LLC. All Rights Reserved.

Reproduction or distribution of this disk, either free or for a fee is strictly prohibited. We actively monitor and remove listings on eBay thru Vero.

You are free to copy or use individual images in your own projects, magazines, brochures or other school projects.

Only the sellers listed here are authorized distributors of this collection:
www.theclassicarchives.com/authorizedsuppliers

Please view our other products at
www.theclassicarchives.com,
or our ebay stores:

[TheClassicArchives](#)
[ADVPlans](#)
[SuperShedPlans](#)

